



# DBS60E-RJFK01024

DBS60

INCREMENTAL ENCODERS

**SICK**  
Sensor Intelligence.



Illustration may differ



### Ordering information

| Type             | Part no. |
|------------------|----------|
| DBS60E-RJFK01024 | 1070744  |

Other models and accessories → [www.sick.com/DBS60](http://www.sick.com/DBS60)

### Detailed technical data

#### Performance

|                                 |                                       |
|---------------------------------|---------------------------------------|
| <b>Pulses per revolution</b>    | 1,024                                 |
| <b>Measuring step</b>           | ≤ 90°, electric/pulses per revolution |
| <b>Measuring step deviation</b> | ± 18° / pulses per revolution         |
| <b>Error limits</b>             | Measuring step deviation x 3          |
| <b>Duty cycle</b>               | ≤ 0.5 ± 5 %                           |

#### Interfaces

|                                       |                         |
|---------------------------------------|-------------------------|
| <b>Communication interface</b>        | Incremental             |
| <b>Communication Interface detail</b> | TTL / HTL <sup>1)</sup> |
| <b>Number of signal channels</b>      | 6-channel               |
| <b>Initialization time</b>            | < 5 ms <sup>2)</sup>    |
| <b>Output frequency</b>               | + 300 kHz <sup>3)</sup> |
| <b>Load current</b>                   | ≤ 30 mA, per channel    |
| <b>Power consumption</b>              | ≤ 0.5 W (without load)  |

<sup>1)</sup> Output level depends on the supply voltage.

<sup>2)</sup> Valid signals can be read once this time has elapsed.

<sup>3)</sup> Up to 450 kHz on request.

#### Electrical data

|  |   |
|--|---|
| <b>Connection type</b>                         | Cable, 8-wire, universal, 1.5 m <sup>1)</sup> |
| <b>Supply voltage</b>                          | 4.5 ... 30 V                                  |
| <b>Reference signal, number</b>                | 1   |
| <b>Reference signal, position</b>              | 90°, electric, logically gated with A and B   |
| <b>Reverse polarity protection</b>             | ✓   |
| <b>Short-circuit protection of the outputs</b> | ✓ <sup>2)</sup>                               |

<sup>1)</sup> The universal cable connection is positioned so that it is possible to lay it without bends in a radial or axial direction.

<sup>2)</sup> Short-circuit opposite to another channel, US or GND permissible for maximum 30 s.

<sup>3)</sup> This product is a standard product and does not constitute a safety component as defined in the Machinery Directive. Calculation based on nominal load of components, average ambient temperature 40°C, frequency of use 8760 h/a. All electronic failures are considered hazardous. For more information, see document no. 8015532.

|  |  |
|--|--|
| <b>MTTFd: mean time to dangerous failure</b> | 500 years (EN ISO 13849-1) <sup>3)</sup> |
|--|--|

<sup>1)</sup> The universal cable connection is positioned so that it is possible to lay it without bends in a radial or axial direction.

<sup>2)</sup> Short-circuit opposite to another channel, US or GND permissible for maximum 30 s.

<sup>3)</sup> This product is a standard product and does not constitute a safety component as defined in the Machinery Directive. Calculation based on nominal load of components, average ambient temperature 40 °C, frequency of use 8760 h/a. All electronic failures are considered hazardous. For more information, see document no. 8015532.

## Mechanical data

|                                       |   |
|---------------------------------------|---|
| <b>Mechanical design</b>              | Through hollow shaft, rear clamping                       |
| <b>Shaft diameter</b>                 | 5/8"  |
| <b>Flange type / stator coupling</b>  | 2-sided stator coupling, slot, screw hole circle 63–83 mm |
| <b>Weight</b>                         | + 0.25 kg <sup>1)</sup>                                   |
| <b>Shaft material</b>                 | Stainless steel   |
| <b>Flange material</b>                | Aluminum  |
| <b>Housing material</b>               | Aluminum  |
| <b>Material, cable</b>                | PVC   |
| <b>Start up torque</b>                | + 0.5 Ncm (+20 °C)  |
| <b>Operating torque</b>               | 0.4 Ncm (+20 °C)  |
| <b>Permissible movement static</b>    | ± 0.3 mm (radial)<br>± 0.5 mm (axial) <sup>2)</sup>       |
| <b>Permissible movement dynamic</b>   | ± 0.1 mm (radial)<br>± 0.2 mm (axial) <sup>2)</sup>       |
| <b>Operating speed</b>                | 6,000 min <sup>-1</sup> <sup>3)</sup>                     |
| <b>Maximum operating speed</b>        | 9,000 min <sup>-1</sup> <sup>4)</sup>                     |
| <b>Moment of inertia of the rotor</b> | 50 gcm <sup>2</sup>                                       |
| <b>Bearing lifetime</b>               | 3.6 x 10 <sup>9</sup> revolutions                         |
| <b>Angular acceleration</b>           | ≤ 500,000 rad/s <sup>2</sup>                              |

<sup>1)</sup> Based on encoder with male connector or cable with male connector.

<sup>2)</sup> Not applicable for stator coupling type C and K.

<sup>3)</sup> Allow for self-heating of 2.6 K per 1,000 rpm when designing the operating temperature range.

<sup>4)</sup> Maximum speed which does not cause mechanical damage to the encoder. Impact on the service life and signal quality is possible. Please note the maximum output frequency.

## Ambient data

|                                      |  |
|--------------------------------------|--|
| <b>EMC</b>                           | According to EN 61000-6-2 and EN 61000-6-3                               |
| <b>Enclosure rating</b>              | IP65, housing side (IEC 60529)<br>IP65, shaft side (IEC 60529)           |
| <b>Permissible relative humidity</b> | 90 % (Condensation not permitted)  |
| <b>Operating temperature range</b>   | -30 °C ... +100 °C, at maximum 3,000 pulses per revolution <sup>1)</sup> |
| <b>Storage temperature range</b>     | -40 °C ... +100 °C, without package                                      |
| <b>Resistance to shocks</b>          | 250 g, 3 ms (EN 60068-2-27)  |
| <b>Resistance to vibration</b>       | 30 g, 10 Hz ... 2,000 Hz (EN 60068-2-6)                                  |

<sup>1)</sup> These values relate to all mechanical versions including recommended accessories unless otherwise noted.

## Classifications

|                   |          |
|-------------------|----------|
| <b>eCl@ss 5.0</b> | 27270501 |
|-------------------|----------|

|                |          |
|----------------|----------|
| eCl@ss 5.1.4   | 27270501 |
| eCl@ss 6.0     | 27270590 |
| eCl@ss 6.2     | 27270590 |
| eCl@ss 7.0     | 27270501 |
| eCl@ss 8.0     | 27270501 |
| eCl@ss 8.1     | 27270501 |
| eCl@ss 9.0     | 27270501 |
| eCl@ss 10.0    | 27270501 |
| eCl@ss 11.0    | 27270501 |
| eCl@ss 12.0    | 27270501 |
| ETIM 5.0       | EC001486 |
| ETIM 6.0       | EC001486 |
| ETIM 7.0       | EC001486 |
| ETIM 8.0       | EC001486 |
| UNSPSC 16.0901 | 41112113 |

### Dimensional drawing (Dimensions in mm (inch))

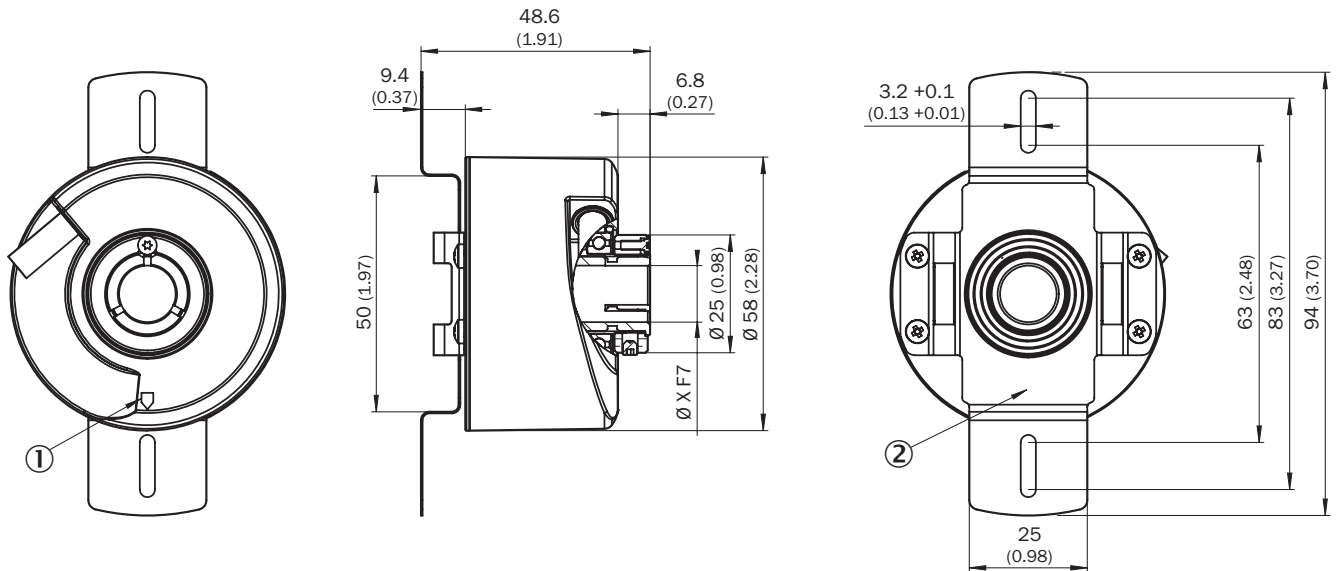

XF7 values see shaft diameter table for through hollow shaft, clamping at the back

- ① Zero pulse mark on housing
- ② Zero pulse mark on flange under stator coupling

| Type                                    | Shaft diameter XF7 |
|---|--------------------|
| Through hollow shaft with rear clamping |                    |
| DBS60x-RAxxxxxxx<br>DBS60x-R1xxxxxxx    | 6 mm               |
| DBS60x-RBxxxxxxx<br>DBS60x-R2xxxxxxx    | 8 mm               |
| DBS60x-RCxxxxxxx<br>DBS60x-R3xxxxxxx    | 3/8"               |

| Type<br>Through hollow shaft<br>with rear clamping | Shaft diameter XF7 |
|--|--------------------|
| DBS60x-RDxxxxxxx<br>DBS60x-R4xxxxxxx               | 10 mm              |
| DBS60x-RExxxxxxx<br>DBS60x-R5xxxxxxx               | 12 mm              |
| DBS60x-RFxxxxxxx<br>DBS60x-R6xxxxxxx               | 1/2"               |
| DBS60x-RGxxxxxxx<br>DBS60x-R7xxxxxxx               | 14 mm              |
| DBS60x-RHxxxxxxx<br>DBS60x-R8xxxxxxx               | 15 mm              |
| DBS60x-RJxxxxxxx                                   | 5/8"               |

Attachment specifications

Through hollow shaft with rear clamping

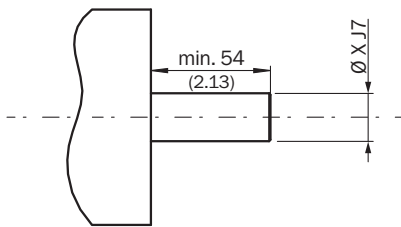

Customer side

| Type<br>Through hollow shaft<br>with rear clamping | Shaft diameter xj7 |
|--|--------------------|
| DBS60x-RAxxxxxxx<br>DBS60x-R1xxxxxxx               | 6 mm               |
| DBS60x-RBxxxxxxx<br>DBS60x-R2xxxxxxx               | 8 mm               |
| DBS60x-RCxxxxxxx<br>DBS60x-R3xxxxxxx               | 3/8"               |
| DBS60x-RDxxxxxxx<br>DBS60x-R4xxxxxxx               | 10 mm              |
| DBS60x-RExxxxxxx<br>DBS60x-R5xxxxxxx               | 12 mm              |
| DBS60x-RFxxxxxxx<br>DBS60x-R6xxxxxxx               | 1/2"               |
| DBS60x-RGxxxxxxx<br>DBS60x-R7xxxxxxx               | 14 mm              |
| DBS60x-RHxxxxxxx<br>DBS60x-R8xxxxxxx               | 15 mm              |
| DBS60x-RJxxxxxxx                                   | 5/8"               |

### PIN assignment



| Wire colors (cable connection) | Male connector M12, 8-pin | Male connector M23, 12-pin | TTL/HTL 6-channel signal | Explanation                         |
|--------------------------------|---------------------------|----------------------------|--------------------------|-------------------------------------|
| Brown                          | 1                         | 6                          | A-                       | Signal wire                         |
| White                          | 2                         | 5                          | A                        | Signal wire                         |
| Black                          | 3                         | 1                          | B-                       | Signal wire                         |
| Pink                           | 4                         | 8                          | B                        | Signal wire                         |
| Yellow                         | 5                         | 4                          | Z-                       | Signal wire                         |
| Purple                         | 6                         | 3                          | Z                        | Signal wire                         |
| Blue                           | 7                         | 10                         | GND                      | Ground connection                   |
| Red                            | 8                         | 12                         | +U <sub>s</sub>          | Supply voltage                      |
| -                              | -                         | 9                          | Not assigned             | Not assigned                        |
| -                              | -                         | 2                          | Not assigned             | Not assigned                        |
| -                              | -                         | 11                         | Not assigned             | Not assigned                        |
| -                              | -                         | 7                          | Not assigned             | Not assigned                        |
| Screen                         | Screen                    | Screen                     | Screen                   | Screen connected to encoder housing |

### Diagrams

Pulses per revolution



Signal outputs for electrical interfaces TTL and HTL



Cw with view on the encoder shaft in direction "A", compare dimensional drawing.

| Supply voltage  | Output            |
|-----------------|-------------------|
| 4,5 V ... 5,5 V | TTL               |
| 10 V ... 30 V   | TTL               |
| 10 V ... 27 V   | HTL               |
| 4,5 V ... 30 V  | TTL/HTL universal |
| 4,5 V ... 30 V  | TTL               |

### Operation note

Through hollow shaft with rear clamping

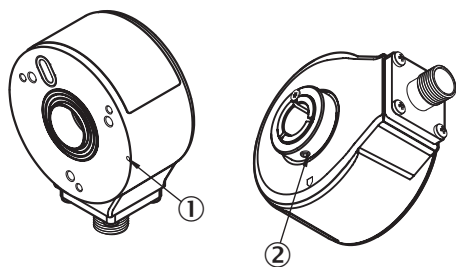





- ① Zero pulse mark on flange
- ② Zero pulse is active when screw of clamping is inline with zero pulse mark on flange or housing mark

### Recommended accessories

Other models and accessories → [www.sick.com/DBS60](http://www.sick.com/DBS60)

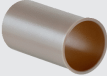
|   | Brief description   | Type           | Part no. |
|---|---|----------------|----------|
| <b>Plug connectors and cables</b>   |   |                |          |
|    | Head A: cable<br>Head B: Flying leads<br>Cable: SSI, Incremental, HIPERFACE®, PUR, halogen-free, shielded | LTG-2308-MWENC | 6027529  |
|    | Head A: cable<br>Head B: Flying leads<br>Cable: SSI, Incremental, PUR, shielded                           | LTG-2411-MW    | 6027530  |
|    | Head A: cable<br>Head B: Flying leads<br>Cable: SSI, Incremental, PUR, halogen-free, shielded             | LTG-2512-MW    | 6027531  |
|    | Head A: cable<br>Head B: Flying leads<br>Cable: SSI, TTL, HTL, Incremental, PUR, halogen-free, shielded   | LTG-2612-MW    | 6028516  |
|    | Head A: male connector, M12, 8-pin, straight, A-coded<br>Cable: Incremental, shielded                     | STE-1208-GA01  | 6044892  |
|    | Head A: male connector, M23, 12-pin, straight<br>Cable: HIPERFACE®, SSI, Incremental, shielded            | STE-2312-G01   | 2077273  |
|    |   | STE-2312-GX    | 6028548  |
| <b>Shaft adaptation</b>   |   |                |          |
|  | Collet plastic insulated for hollow shaft, shaft diameter 6 mm, outer diameter 5/8" (15.875 mm), plastic  | SPZ-58Z-006-P  | 2076228  |
|  | Collet metal for hollow shaft, shaft diameter 8 mm, outer diameter 5/8" (15.875 mm), metal                | SPZ-58Z-008-M  | 2076219  |
|  | Collet plastic insulated for hollow shaft, shaft diameter 8 mm, outer diameter 5/8" (15.875 mm), plastic  | SPZ-58Z-008-P  | 2076229  |
|  | Collet metal for hollow shaft, shaft diameter 10 mm, outer diameter 5/8" (15.875 mm), metal               | SPZ-58Z-010-M  | 2076220  |
|  | Collet plastic insulated for hollow shaft, shaft diameter 10 mm, outer diameter 5/8" (15.875 mm), plastic | SPZ-58Z-010-P  | 2076230  |
|  | Collet metal for hollow shaft, shaft diameter 11 mm, outer diameter 5/8" (15.875 mm), metal               | SPZ-58Z-011-M  | 2094671  |
|  | Collet metal for hollow shaft, shaft diameter 12 mm, outer diameter 5/8" (15.875 mm), metal               | SPZ-58Z-012-M  | 2076221  |
|  | Collet plastic insulated for hollow shaft, shaft diameter 12 mm, outer diameter 5/8" (15.875 mm), plastic | SPZ-58Z-012-P  | 2076231  |
|  | Collet metal for hollow shaft, shaft diameter 14 mm, outer diameter 5/8" (15.875 mm), metal               | SPZ-58Z-014-M  | 2076222  |

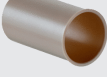

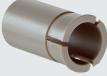
|   | Brief description   | Type          | Part no. |
|---|---|---------------|----------|
|  | Collet plastic insulated for hollow shaft, shaft diameter 14 mm, outer diameter 5/8" (15.875 mm), plastic           | SPZ-58Z-014-P | 2076232  |
|  | Collet metal for hollow shaft, shaft diameter 15 mm, outer diameter 5/8" (15.875 mm), metal                         | SPZ-58Z-015-M | 2076223  |
|  | Collet plastic insulated for hollow shaft, shaft diameter 15 mm, outer diameter 5/8" (15.875 mm), plastic           | SPZ-58Z-015-P | 2076233  |
|  | Collet metal for hollow shaft, shaft diameter 1/2" (12.7 mm), outer diameter 5/8" (15.875 mm), metal                | SPZ-58Z-12Z-M | 2076225  |
|   | Collet plastic insulated for hollow shaft, shaft diameter 1/2" (12.7 mm), outer diameter 5/8" (15.875 mm), plastic  | SPZ-58Z-12Z-P | 2076227  |
|  | Collet metal for hollow shaft, shaft diameter 3/8" (9.525 mm), outer diameter 5/8" (15.875 mm), metal               | SPZ-58Z-38Z-M | 2076224  |
|   | Collet plastic insulated for hollow shaft, shaft diameter 3/8" (9.525 mm), outer diameter 5/8" (15.875 mm), plastic | SPZ-58Z-38Z-P | 2076226  |

## SICK AT A GLANCE

SICK is one of the leading manufacturers of intelligent sensors and sensor solutions for industrial applications. A unique range of products and services creates the perfect basis for controlling processes securely and efficiently, protecting individuals from accidents and preventing damage to the environment.

We have extensive experience in a wide range of industries and understand their processes and requirements. With intelligent sensors, we can deliver exactly what our customers need. In application centers in Europe, Asia and North America, system solutions are tested and optimized in accordance with customer specifications. All this makes us a reliable supplier and development partner.

Comprehensive services complete our offering: SICK LifeTime Services provide support throughout the machine life cycle and ensure safety and productivity.

For us, that is “Sensor Intelligence.”

## WORLDWIDE PRESENCE:

Contacts and other locations –[www.sick.com](http://www.sick.com)