



# DBS60E-S1EC00360

DBS60

INCREMENTAL ENCODERS

**SICK**  
Sensor Intelligence.



Illustration may differ



### Ordering information

Type	Part no.
DBS60E-S1EC00360	1087545

Other models and accessories → [www.sick.com/DBS60](http://www.sick.com/DBS60)

### Detailed technical data

#### Performance

<b>Pulses per revolution</b>	360
<b>Measuring step</b>	≤ 90°, electric/pulses per revolution
<b>Measuring step deviation</b>	± 18° / pulses per revolution
<b>Error limits</b>	Measuring step deviation x 3
<b>Duty cycle</b>	≤ 0.5 ± 5 %

#### Interfaces

<b>Communication interface</b>	Incremental
<b>Communication Interface detail</b>	HTL / Push pull
<b>Number of signal channels</b>	6-channel
<b>Initialization time</b>	< 5 ms <sup>1)</sup>
<b>Output frequency</b>	+ 300 kHz <sup>2)</sup>
<b>Load current</b>	≤ 30 mA, per channel
<b>Power consumption</b>	≤ 1 W (without load)

<sup>1)</sup> Valid signals can be read once this time has elapsed.

<sup>2)</sup> Up to 450 kHz on request.

#### Electrical data

<b>Connection type</b>	Male connector, M12, 8-pin, radial
<b>Supply voltage</b>	10 ... 27 V
<b>Reference signal, number</b>	1
<b>Reference signal, position</b>	90°, electric, logically gated with A and B
<b>Reverse polarity protection</b>	✓
<b>Short-circuit protection of the outputs</b>	✓ <sup>1)</sup>

<sup>1)</sup> Short-circuit opposite to another channel, US or GND permissible for maximum 30 s.

<sup>2)</sup> This product is a standard product and does not constitute a safety component as defined in the Machinery Directive. Calculation based on nominal load of components, average ambient temperature 40°C, frequency of use 8760 h/a. All electronic failures are considered hazardous. For more information, see document no. 8015532.

<b>MTTFd: mean time to dangerous failure</b>	500 years (EN ISO 13849-1) <sup>2)</sup>
--	--

<sup>1)</sup> Short-circuit opposite to another channel, US or GND permissible for maximum 30 s.

<sup>2)</sup> This product is a standard product and does not constitute a safety component as defined in the Machinery Directive. Calculation based on nominal load of components, average ambient temperature 40 °C, frequency of use 8760 h/a. All electronic failures are considered hazardous. For more information, see document no. 8015532.

## Mechanical data

<b>Mechanical design</b>	Solid shaft, Servo flange
<b>Shaft diameter</b>	6 mm
<b>Shaft length</b>	10 mm
<b>Flange type / stator coupling</b>	Flange with 3 x M3 and 3 x M4
<b>Weight</b>	+ 0.3 kg <sup>1)</sup>
<b>Shaft material</b>	Stainless steel
<b>Flange material</b>	Aluminum
<b>Housing material</b>	Aluminum
<b>Start up torque</b>	+ 1.2 Ncm (+20 °C)
<b>Operating torque</b>	1.1 Ncm (+20 °C)
<b>Permissible shaft loading</b>	100 N (radial) <sup>2)</sup> 50 N (axial) <sup>2)</sup>
<b>Operating speed</b>	6,000 min <sup>-1</sup> <sup>3)</sup>
<b>Maximum operating speed</b>	9,000 min <sup>-1</sup> <sup>4)</sup>
<b>Moment of inertia of the rotor</b>	33 gcm <sup>2</sup>
<b>Bearing lifetime</b>	3.6 x 10 <sup>9</sup> revolutions
<b>Angular acceleration</b>	≤ 500,000 rad/s <sup>2</sup>

<sup>1)</sup> Based on encoder with male connector or cable with male connector.

<sup>2)</sup> Higher values are possible using limited bearing life.

<sup>3)</sup> Allow for self-heating of 3.2 K per 1,000 rpm when designing the operating temperature range.

<sup>4)</sup> Maximum speed which does not cause mechanical damage to the encoder. Impact on the service life and signal quality is possible. Please note the maximum output frequency.

## Ambient data

<b>EMC</b>	According to EN 61000-6-2 and EN 61000-6-3
<b>Enclosure rating</b>	IP67, housing side (IEC 60529) <sup>1)</sup> IP65, shaft side (IEC 60529)
<b>Permissible relative humidity</b>	90 % (Condensation not permitted)
<b>Operating temperature range</b>	-20 °C ... +85 °C <sup>2)</sup>
<b>Storage temperature range</b>	-40 °C ... +100 °C, without package
<b>Resistance to shocks</b>	250 g, 3 ms (EN 60068-2-27)
<b>Resistance to vibration</b>	30 g, 10 Hz ... 2,000 Hz (EN 60068-2-6)

<sup>1)</sup> With mating connector fitted.

<sup>2)</sup> These values relate to all mechanical versions including recommended accessories unless otherwise noted.

## Classifications

<b>eCI@ss 5.0</b>	27270501
<b>eCI@ss 5.1.4</b>	27270501
<b>eCI@ss 6.0</b>	27270590



### Attachment specifications

Mounting requirements for small servo clamp

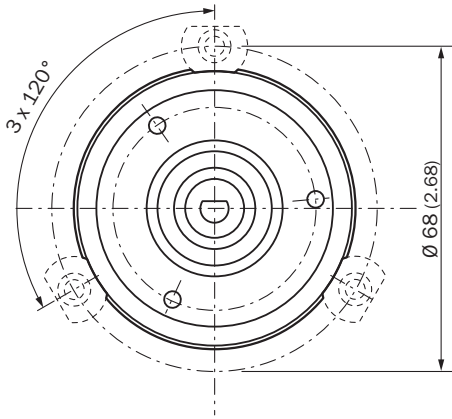

All dimensions in mm (inch)

Mounting requirements for half-shell servo clamp

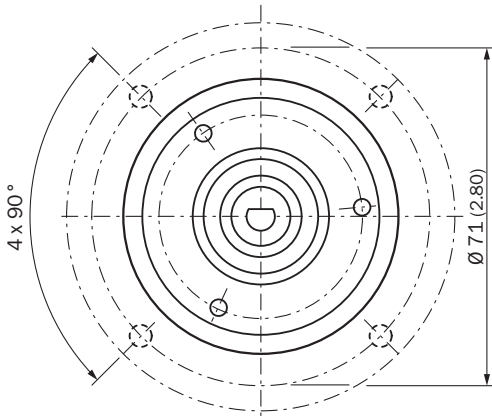

All dimensions in mm (inch)

### PIN assignment

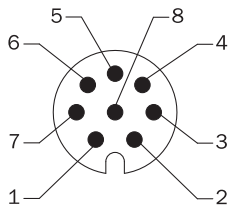

View of M12 male device connector on cable / housing

Wire colors (cable connection)	Male connector M12, 8-pin	Male connector M23, 12-pin	TTL/HTL 6-channel signal	Explanation
Brown	1	6	A-	Signal wire
White	2	5	A	Signal wire
Black	3	1	B-	Signal wire
Pink	4	8	B	Signal wire

Wire colors (cable connection)	Male connector M12, 8-pin	Male connector M23, 12-pin	TTL/HTL 6-channel signal	Explanation
Yellow	5	4	Z-	Signal wire
Purple	6	3	Z	Signal wire
Blue	7	10	GND	Ground connection
Red	8	12	+U <sub>s</sub>	Supply voltage
-	-	9	Not assigned	Not assigned
-	-	2	Not assigned	Not assigned
-	-	11	Not assigned	Not assigned
-	-	7	Not assigned	Not assigned
Screen	Screen	Screen	Screen	Screen connected to encoder housing

### Diagrams

Pulses per revolution

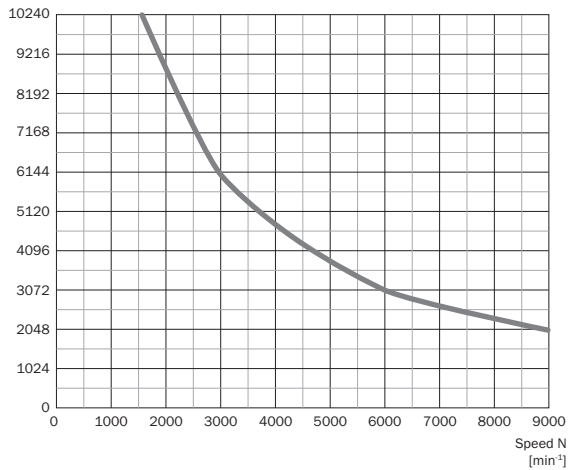

Signal outputs for electrical interfaces TTL and HTL



Cw with view on the encoder shaft in direction "A", compare dimensional drawing.

Supply voltage	Output
4,5 V ... 5,5 V	TTL
10 V ... 30 V	TTL
10 V ... 27 V	HTL
4,5 V ... 30 V	TTL/HTL universal
4,5 V ... 30 V	TTL

### Operation note

Solid shaft, servo flange

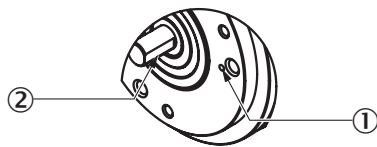













- ① Zero pulse mark on flange
- ② Zero pulse active when the surface of the shaft shows the zero pulse mark on the flange

### Recommended accessories









Other models and accessories → [www.sick.com/DBS60](http://www.sick.com/DBS60)

	Brief description	Type	Part no.
Other mounting accessories			
	Aluminium measuring wheel with O-ring (NBR70) for 6 mm solid shaft, circumference 200 mm	BEF-MR006020R	2055222
	Measuring wheel with O-ring (NBR70) for 6 mm solid shaft, circumference 300 mm	BEF-MR006030R	2055634

	<b>Brief description</b>	<b>Type</b>	<b>Part no.</b>
	Aluminium measuring wheel with O-ring (NBR70) for 6 mm solid shaft, circumference 500 mm	BEF-MR006050R	2055225
	Aluminum measuring wheel with cross-knurled surface for 6 mm solid shaft, circumference 200 mm	BEF-MR06200AK	4084745
	Aluminum measuring wheel with smooth polyurethane surface for 6 mm solid shaft, circumference 200 mm	BEF-MR06200AP	4084746
	Aluminum measuring wheel with ridged polyurethane surface for 6 mm solid shaft, circumference 200 mm	BEF-MR06200APG	4084748
	Aluminum measuring wheel with studded polyurethane surface for 6 mm solid shaft, circumference 200 mm	BEF-MR06200APN	4084747
	O-ring for measuring wheels (circumference 200 mm)	BEF-OR-053-040	2064061
	O-ring for measuring wheels (circumference 300 mm), 2x O-ring	BEF-OR-083-050	2064076
	O-ring for measuring wheels (circumference 500 mm)	BEF-OR-145-050	2064074
	Mounting bell for encoder with servo flange, 50 mm spigot, mounting kit included	BEF-MG-50	5312987
	Bearing block for servo and face mount flange encoder. The heavy-duty bearing block is used to absorb very large radial and axial shaft loads. Particularly when using belt pulleys, chain sprockets, friction wheels. Operating speed max. 4,000 rpm <sup>-1</sup> , axial shaft load 150 N, radial shaft load 250 N, bearing service life 3.6 x 10 <sup>9</sup> revolutions	BEF-FA-LB1210	2044591
	Mounting kit for servo flange encoder on the bearing block, 1 bar coupling SKPS 1520 06/06 1 hexagon socket wrench SW1.5 DIN 911, 3 mounting eccentric BEMN 1242 49 3 screws M4 x 10 DIN 912, 1 hexagon socket wrench SW3 DIN 911, 1 bar coupling SKPS 1520 06/06 1 hexagon socket wrench SW1.5 DIN 911, 3 mounting eccentric BEMN 1242 49 3 screws M4 x 10 DIN 912, 1 hexagon socket wrench SW3 DIN 911	BEF-MK-LB	5320872
	Half-shell servo clamps (2 pcs.) for servo flanges with a 50 mm centering hub	BEF-WG-SF050	2029165
	Servo clamps, large, for servo flange (clamps, eccentric fastener), 3 pcs, without mounting material, without mounting hardware	BEF-WK-SF	2029166
<b>Plug connectors and cables</b>			
	Head A: cable Head B: Flying leads Cable: SSI, Incremental, HIPERFACE <sup>®</sup> , PUR, halogen-free, shielded	LTG-2308-MWENC	6027529
	Head A: cable Head B: Flying leads Cable: SSI, Incremental, PUR, shielded	LTG-2411-MW	6027530
	Head A: cable Head B: Flying leads Cable: SSI, Incremental, PUR, halogen-free, shielded	LTG-2512-MW	6027531
	Head A: cable Head B: Flying leads Cable: SSI, TTL, HTL, Incremental, PUR, halogen-free, shielded	LTG-2612-MW	6028516
	Head A: female connector, M12, 8-pin, straight Head B: Flying leads Cable: Incremental, SSI, PUR, halogen-free, shielded, 2 m	DOL-1208-G02MAC1	6032866



	<b>Brief description</b>	<b>Type</b>	<b>Part no.</b>
	Head A: female connector, M12, 8-pin, straight Head B: Flying leads Cable: Incremental, SSI, PUR, halogen-free, shielded, 5 m	DOL-1208-G05MAC1	6032867
	Head A: female connector, M12, 8-pin, straight Head B: Flying leads Cable: Incremental, SSI, PUR, halogen-free, shielded, 10 m	DOL-1208-G10MAC1	6032868
	Head A: female connector, M12, 8-pin, straight Head B: Flying leads Cable: Incremental, SSI, PUR, halogen-free, shielded, 20 m	DOL-1208-G20MAC1	6032869
	Head A: female connector, M12, 8-pin, straight Head B: Flying leads Cable: Incremental, SSI, PUR, halogen-free, shielded, 25 m	DOL-1208-G25MAC1	6067859
	Head A: female connector, M12, 8-pin, angled Head B: Flying leads Cable: PVC, shielded, 2 m	DOL-1208-W02MA	6020992
	Head A: female connector, M12, 8-pin, angled Head B: Flying leads Cable: HIPERFACE <sup>®</sup> , Incremental, PUR, halogen-free, shielded, 2 m	DOL-1208-W02MAC1	6037724
	Head A: female connector, M12, 8-pin, angled Head B: Flying leads Cable: Sensor/actuator cable, PUR, halogen-free, shielded, 2 m	DOL-1208-W02MAS01	6029224
	Head A: female connector, M12, 8-pin, angled Head B: Flying leads Cable: PUR, halogen-free, unshielded, 2 m	DOL-1208-W02MC	6035623
	Head A: female connector, M12, 8-pin, angled Head B: Flying leads Cable: PVC, shielded, 5 m	DOL-1208-W05MA	6021033
	Head A: female connector, M12, 8-pin, angled Head B: Flying leads Cable: HIPERFACE <sup>®</sup> , Incremental, PUR, halogen-free, shielded, 5 m	DOL-1208-W05MAC1	6037725
	Head A: female connector, M12, 8-pin, angled Head B: Flying leads Cable: PUR, unshielded, 5 m	DOL-1208-W05MC	6035624
	Head A: female connector, M12, 8-pin, angled Head B: Flying leads Cable: HIPERFACE <sup>®</sup> , Incremental, PUR, halogen-free, shielded, 10 m	DOL-1208-W10MAC1	6037726
	Head A: female connector, M12, 8-pin, angled Head B: Flying leads Cable: PUR, halogen-free, unshielded, 10 m	DOL-1208-W10MC	6035625
	Head A: female connector, M12, 8-pin, angled Head B: Flying leads Cable: HIPERFACE <sup>®</sup> , Incremental, PUR, shielded, 20 m	DOL-1208-W20MAC1	6037727
	Head A: female connector, M12, 8-pin, straight, A-coded Head B: male connector, M12, 8-pin, straight, A-coded Cable: PUR, halogen-free, shielded, 2 m Drag chain use	YF2AA8-020S01MKA18	2099207
	Head A: female connector, M12, 8-pin, straight, A-coded Head B: male connector, M12, 8-pin, straight, A-coded Cable: PUR, halogen-free, shielded, 5 m Drag chain use	YF2AA8-050S01MKA18	2099209
	Head A: female connector, M12, 8-pin, straight, A-coded Head B: male connector, M12, 8-pin, straight, A-coded Cable: PUR, halogen-free, shielded, 10 m Drag chain use	YF2AA8-100S01MKA18	2099210

	Brief description	Type	Part no.
	Head A: female connector, M12, 8-pin, straight, A-coded Head B: male connector, M12, 8-pin, straight, A-coded Cable: PUR, halogen-free, shielded, 20 m Drag chain use	YF2AA8-200S01MKA18	2099208
	Head A: female connector, M12, 8-pin, straight, A-coded Cable: Incremental, SSI, shielded	DOS-1208-GA01	6045001
<b>Shaft adaptation</b>			
	Bellows coupling, shaft diameter 6 mm / 6 mm, maximum shaft offset: radial $\pm 0.25$ mm, axial $\pm 0.4$ mm, angular $\pm 4^\circ$ ; max. speed 10,000 rpm, $-30^\circ\text{C}$ to $+120^\circ\text{C}$ , max. torque 120 Ncm; material: stainless steel bellows, aluminum hub	KUP-0606-B	5312981
	Cross-slotted coupling, shaft diameter 6 mm / 6 mm, maximum shaft offset: radial $\pm 0.3$ mm, axial $\pm 0.2$ mm, angle $\pm 3^\circ$ ; max. speed 10,000 rpm, $-10^\circ$ to $+80^\circ\text{C}$ , max. torque 80 Ncm; material: fiber-glass reinforced polyamide, aluminum hub	KUP-0606-S	2056406
	Bar coupling, shaft diameter 6 mm / 8 mm, maximum shaft offset radial $\pm 0.3$ mm, axial $\pm 0.2$ mm, angle $\pm 3^\circ$ , max. speed 10,000 rpm, torsion spring rigidity 38 Nm/wheel; material: fiber-glass reinforced polyamide, aluminum hub	KUP-0608-S	5314179
	Bellows coupling, shaft diameter 6 mm / 10 mm, maximum shaft offset: radial $\pm 0.25$ mm, axial $\pm 0.4$ mm, angular $\pm 4^\circ$ ; max. speed 10,000 rpm, $-30^\circ\text{C}$ to $+120^\circ\text{C}$ , max. torque 120 Ncm; material: stainless steel bellows, aluminum hub	KUP-0610-B	5312982
	Double loop coupling, shaft diameter 6 mm / 10 mm, max. shaft offset: radially $\pm 2.5$ mm, axially $\pm 3$ mm, angle $\pm 10$ degrees; max. speed 3.000 rpm, $-30$ to $+80$ degrees Celsius, torsional spring stiffness of 25 Nm/rad	KUP-0610-D	5326697
	Spring washer coupling, shaft diameter 6 mm / 10 mm, Maximum shaft offset: radial $\pm 0.3$ mm, axial $\pm 0.4$ mm, angular $\pm 2.5^\circ$ ; max. speed 12,000 rpm, $-10^\circ$ to $+80^\circ\text{C}$ , max. torque 60 Ncm; material: aluminum flange, glass fiber-reinforced polyamide membrane and hardened steel coupling pin	KUP-0610-F	5312985
	Claw coupling, shaft diameter 6 mm / 10 mm, damping element 80 shore blue, maximum shaft offset: radial $\pm 0.22$ mm, axial $\pm 1$ mm angular $\pm 1.3^\circ$ , max. speed 19,000 rpm, angle of twist max. $10^\circ$ , $-30^\circ\text{C}$ to $+80^\circ\text{C}$ , max. torque 800 Ncm, tightening torque of screws: ISO 4029 150 Ncm, material: aluminum flange, damping element: polyurethane	KUP-0610-J	2127056
	Bar coupling, shaft diameter 6 mm / 10 mm, max. shaft offset: radial $\pm 0.3$ mm, axial $\pm 0.3$ mm, angular $\pm 3^\circ$ ; max. speed 10.000 rpm, $-10^\circ$ to $+80^\circ\text{C}$ , max. torque: 80 Ncm, material: fiber-glass reinforced polyamide, aluminum hub	KUP-0610-S	2056407

## SICK AT A GLANCE

SICK is one of the leading manufacturers of intelligent sensors and sensor solutions for industrial applications. A unique range of products and services creates the perfect basis for controlling processes securely and efficiently, protecting individuals from accidents and preventing damage to the environment.

We have extensive experience in a wide range of industries and understand their processes and requirements. With intelligent sensors, we can deliver exactly what our customers need. In application centers in Europe, Asia and North America, system solutions are tested and optimized in accordance with customer specifications. All this makes us a reliable supplier and development partner.

Comprehensive services complete our offering: SICK LifeTime Services provide support throughout the machine life cycle and ensure safety and productivity.

For us, that is “Sensor Intelligence.”

## WORLDWIDE PRESENCE:

Contacts and other locations –[www.sick.com](http://www.sick.com)