



LLTE-R1400111020E3

LLX

FIBERS

SICK
Sensor Intelligence.



Illustration may differ

Ordering information

Type	Part no.
LLTE-R1400111020E3	2115014

Included in delivery: LLAC-AB10 (1), LLAC-AB13 (1), LLAC-FC (1)

Other models and accessories → www.sick.com/LLX

Detailed technical data

Features

Device type	Fibers
Functional principle	Proximity system
Fiber-optic cable cuttable	✓
Special features	Coaxial fiber arrangement
Adapter sleeves required	Yes (1 x LLAC-AB10 / 1 x LLAC-AB13)
Items supplied	1 x fiber cutter (LLAC-FC), M4 mounting set (2 x M4 nut + 2 x M4 washer), 2 x fiber adapter bushing (1 x LLAC-AB10 + 1 x LLAC-AB13)

Mechanical data

Housing	Cylindrical with thread
Design detail	Radial
Thread diameter (housing)	M4
Connection detail	
Cable diameter	1 x 1.0 mm (sender) / 1 x 1.3 mm (receiver)
Length of cable (L)	2 m
Bending radius	5 mm
Material	
Housing	Stainless steel, Stainless steel V2A (1.4301)
Cable	Plastic, PE
Fibers	Plastic, PMMA
Fiber diameter (and quantity of fibers)	1 x 0.5 mm (sender) / 9 x 0.25 mm (receiver)

Ambient data

Ambient operating temperature	-40 °C ... +60 °C
RoHS certificate	✓

Classifications

eCl@ss 5.0	27270905
eCl@ss 5.1.4	27270905
eCl@ss 6.0	27270905
eCl@ss 6.2	27270905

eCl@ss 7.0	27270905
eCl@ss 8.0	27270905
eCl@ss 8.1	27270905
eCl@ss 9.0	27270905
eCl@ss 10.0	27270905
eCl@ss 11.0	27270905
eCl@ss 12.0	27270905
ETIM 5.0	EC002651
ETIM 6.0	EC002651
ETIM 7.0	EC002651
ETIM 8.0	EC002651
UNSPSC 16.0901	39121528

Sensing ranges with WLL180T

Operating mode 16 µs	25 mm
Operating mode 70 µs	60 mm
Operating mode 250 µs	115 mm
Operating mode 2 ms	250 mm
Operating mode 8 ms	280 mm

Sensing ranges with GLL170

Operating mode 250 µs	30 mm
------------------------------	-------

Sensing ranges with GLL170T

Operating mode 50 µs	40 mm
Operating mode 250 µs	65 mm

Dimensional drawing (Dimensions in mm (inch))

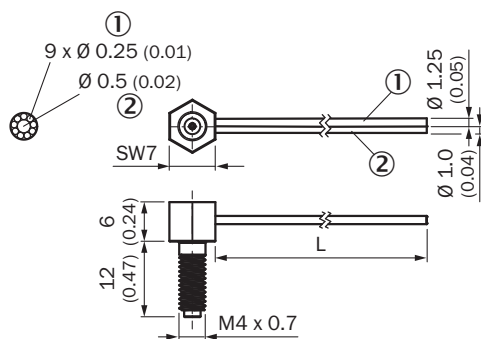



For length of cable (L), see technical data

- ① Receiver
- ② Sender

Recommended accessories

Other models and accessories → www.sick.com/LLX

	Brief description	Type	Part no.
Other adapters			
	Adapter sleeve for Ø 1.0 mm LLX fibers for adaptation to Ø 2.2 mm, in LLX scope of delivery	LLAC-AB10	2119446
	Adapter sleeve for Ø 1.3 mm LLX fibers for adaptation to Ø 2.2 mm, in LLX scope of delivery	LLAC-AB13	2119447
	Fiber cutting tool, in LLX scope of delivery	LLAC-FC	2119448

SICK AT A GLANCE

SICK is one of the leading manufacturers of intelligent sensors and sensor solutions for industrial applications. A unique range of products and services creates the perfect basis for controlling processes securely and efficiently, protecting individuals from accidents and preventing damage to the environment.

We have extensive experience in a wide range of industries and understand their processes and requirements. With intelligent sensors, we can deliver exactly what our customers need. In application centers in Europe, Asia and North America, system solutions are tested and optimized in accordance with customer specifications. All this makes us a reliable supplier and development partner.

Comprehensive services complete our offering: SICK LifeTime Services provide support throughout the machine life cycle and ensure safety and productivity.

For us, that is “Sensor Intelligence.”

WORLDWIDE PRESENCE:

Contacts and other locations –www.sick.com