

Dual Band 900 MHz and 2.4 GHz Chip Antenna, Single-feed

Johanson Technology, Inc. (JTI) miniature RF ceramic chip antennas are made using Low Temperature Co-fired Ceramic (LTCC) technology which has the ability to embed low and high dielectric constants inside our antenna. This enables our components to have high detuning resilience and stability over extreme temperatures (~2ppm).

Recommended mounting locations for this antenna

PCB End

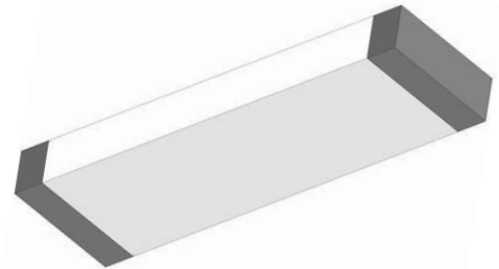
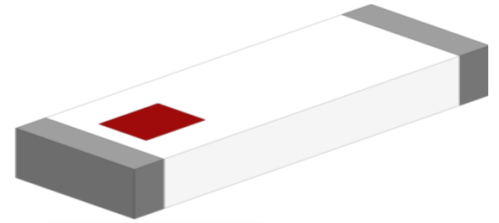

General Specifications^{1 2}

Passband Frequency (MHz)	868 - 928	2400 - 2480
Impedance (Ω)	50	50
Return Loss (dB)	6.5 Typ. (4.4 Min.)	6.5 Typ. (4.4 Min.)
Peak Gain (dBi)	1.5 Typ.	-0.5 Typ.
Average Gain (dBi)	-2.5 Typ.	-3.0 Typ.
Average Radiated Efficiency (%)	38	52

Maximum Ratings

Power Capacity (W)	3 Max. (CW)
Operating Temperature ($^{\circ}\text{C}$)	-40 to +85
Recommended Storage Conditions post-installation ($^{\circ}\text{C}$)	-40 to +85
Recommended Storage Conditions and Period for Unused T&R Product	45% - 75% RH +5 to +35 $^{\circ}\text{C}$ 18 Months Max.

¹ Typical value represents average measurement at 25 $^{\circ}\text{C}$. Min./Max. values represent measurements over specified operating temperature.

² General specifications measured on Johanson's evaluation board P/N 0900AD54B2450001CE1.

Mechanical Dimensions

	Inches			Millimeters		
L	0.591	±	0.008	15.00	±	0.20
W	0.157	±	0.008	4.00	±	0.20
T	0.059	±	0.008	1.50	±	0.20
a	0.039	±	0.012	1.00	±	0.30

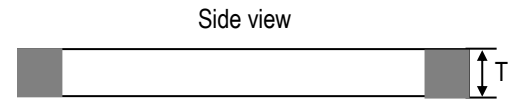
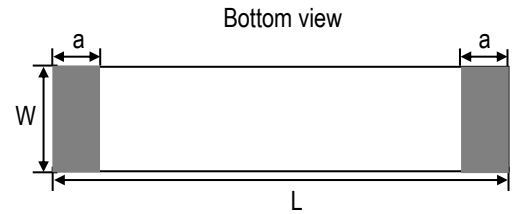

Terminal Configuration³

Pin Number	Function
1	Feed
2	NC*

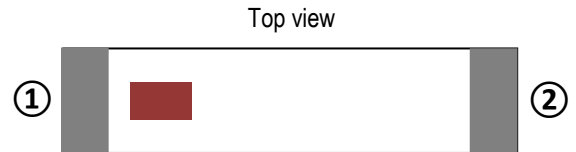

³ The termination type is Nickel Tin. Go to: <https://www.johansontechnology.com/ipcsoldering-profile> for Typical Soldering Profile.

* This terminal must be soldered for anchoring and mechanical stability.

Evaluation Board and Recommended Mounting Configuration (P/N 0900AD54B2450001CE1)

All units in mm

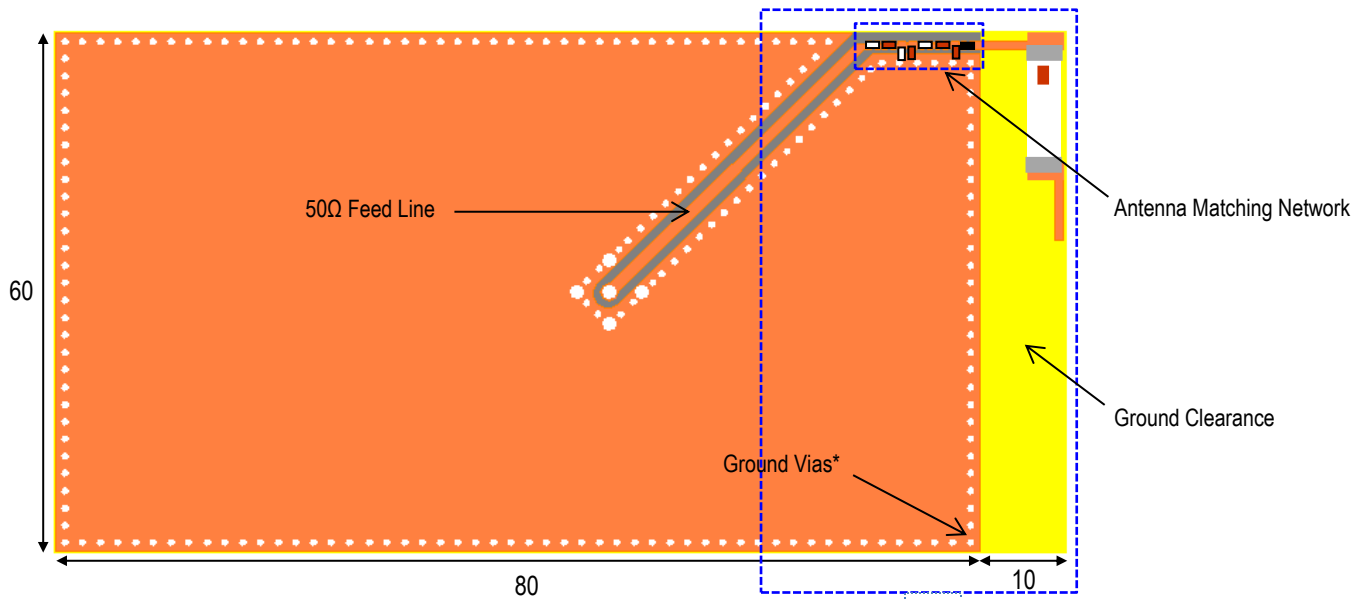

JTI P/Ns for Matching Network⁴

- R0 (0Ω)
- L1 (13nH): LRW0402WJ13NNGG001T
- L2 (3.9nH): LRW0402WC3N9GG001T
- C2 (0.6pF): QSCF500Q0R6B1GV001T
- L3 (6.8nH): LRW0402WJ6N8GG001T
- C3 (0.8pF): QSCF500Q0R8B1GV001T
- L4 (7.0nH): *Murata LQW15AN7N0J8ZD*
- C4 (1.8pF): QSCF500Q1R8B1GV001T

Antenna Matching Network
(Wire-wound inductors used in matching)

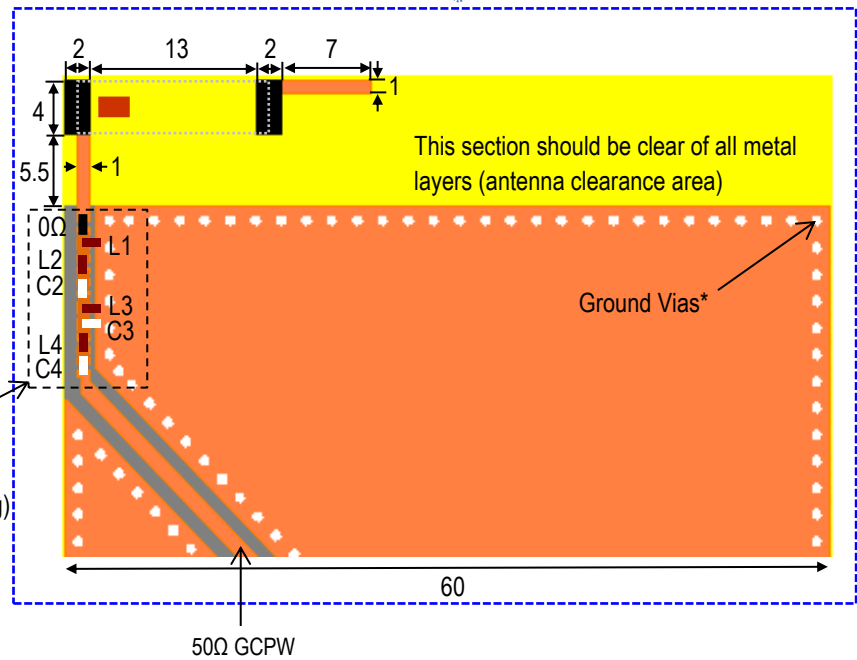

*Note: Ground Vias are highly recommended to have better antenna efficiency.

If you'd like the CAD PCB layout or have any questions,
contact our application engineers at <https://www.johansontechnology.com/ask-a-question>

⁴ It is recommended that the designer leave available slots for the topology of the network. The antenna matching network values above are used when the antenna is mounted on Johanson's evaluation board. The optimal matching values will vary depending on the layout, thickness, material, etc. Go to: <https://www.johansontechnology.com/tuning> for more information.

Evaluation Board Typical Return Loss Measurement (P/N 0900AD54B2450001CE1)

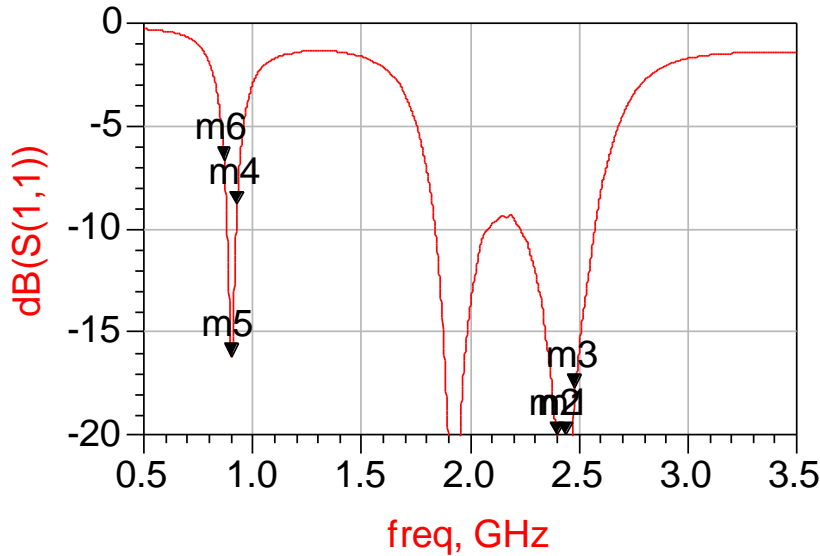

m6
freq=868.0MHz
dB(S(1,1))=-6.722

m5
freq=900.0MHz
dB(S(1,1))=-16.237

m4
freq=928.0MHz
dB(S(1,1))=-8.819

m2
freq=2.400GHz
dB(S(1,1))=-20.252

m1
freq=2.440GHz
dB(S(1,1))=-23.639

m3
freq=2.480GHz
dB(S(1,1))=-17.712

Evaluation Board Typical 2D Radiation Patterns (P/N 0900AD54B2450001CE1)

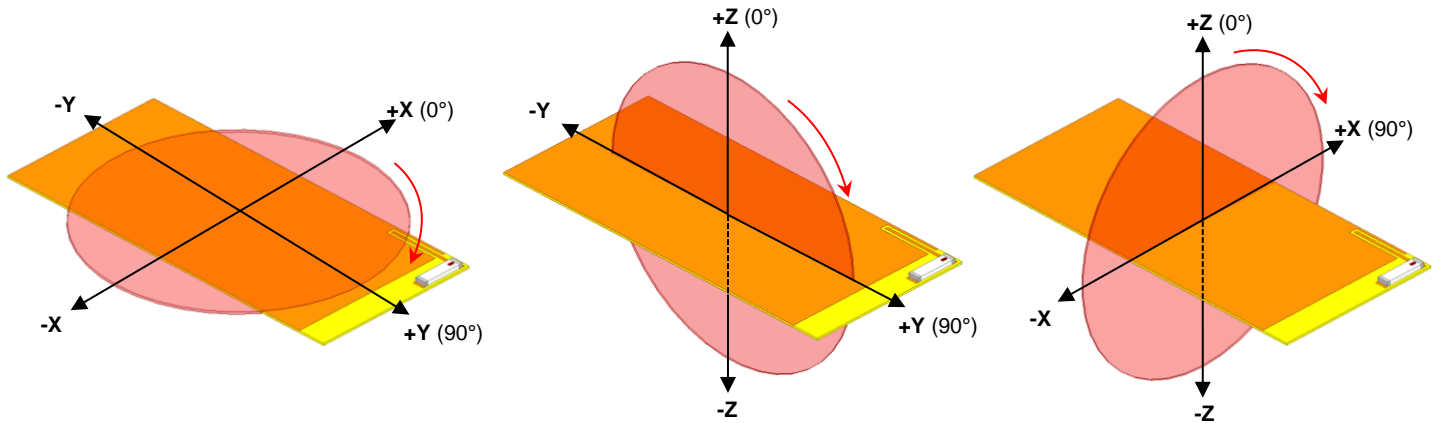

@900MHz Band

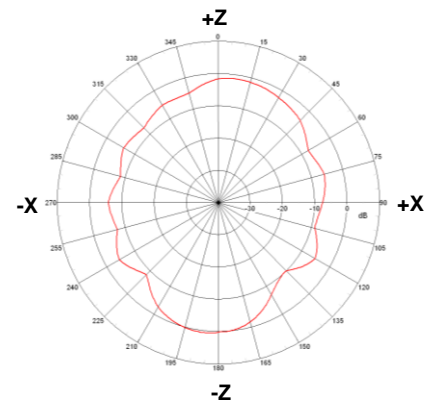
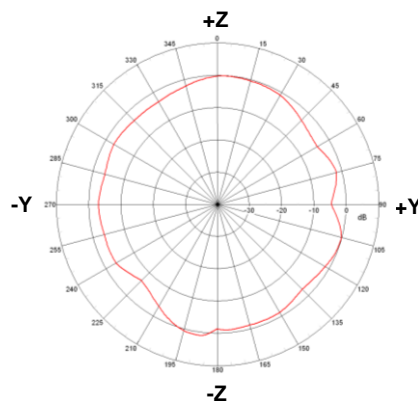
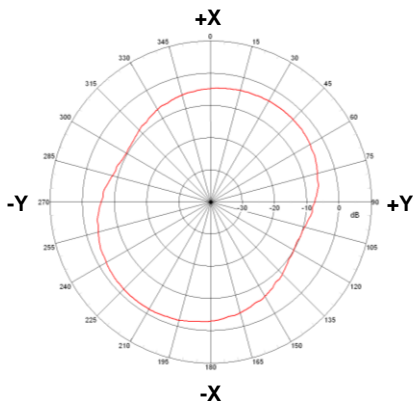

@2440MHz Band

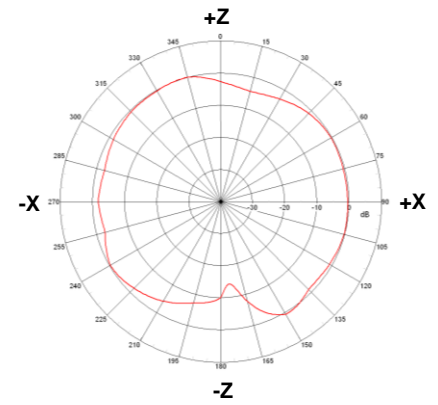
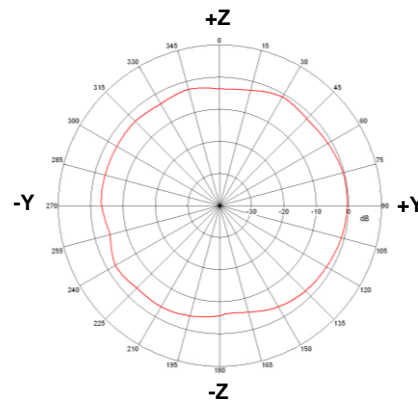
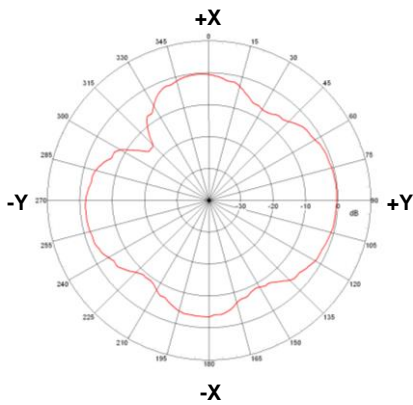

Tape and Reel Specification (Units in mm)

Tape Dimensions

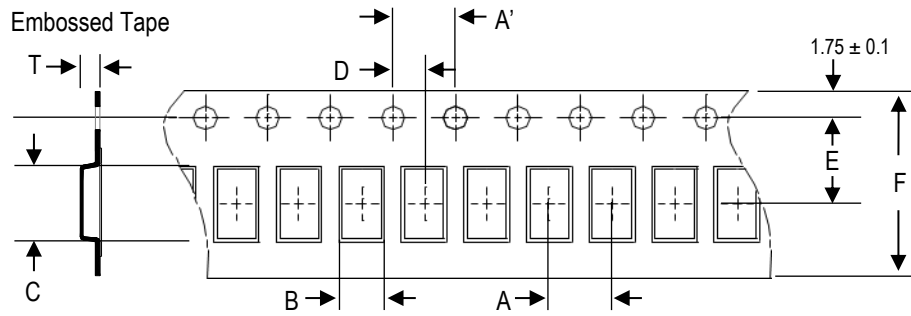

A	A'	B	C	D	E	F	T	Quantity/reel	Tape material
8.0±0.1	4.0±0.1	4.3±0.1	15.3±0.1	2.0±0.01	11.5±0.1	24.0±0.3	1.8±0.1	500pcs.	Plastic (Embossed)

Reel Dimensions

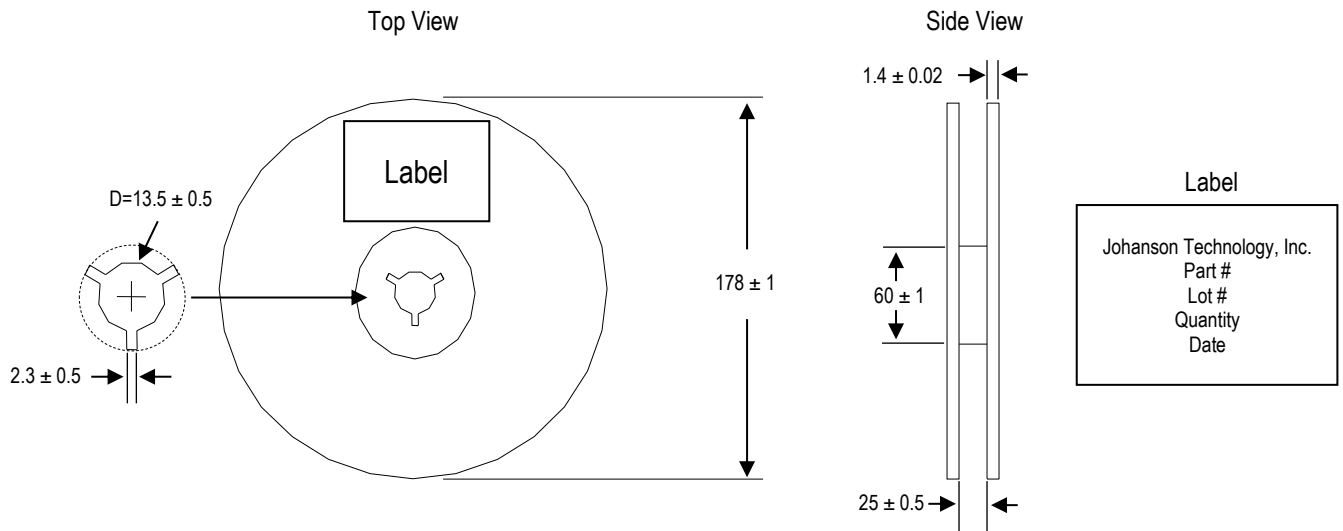

Leader and Trailer Dimensions

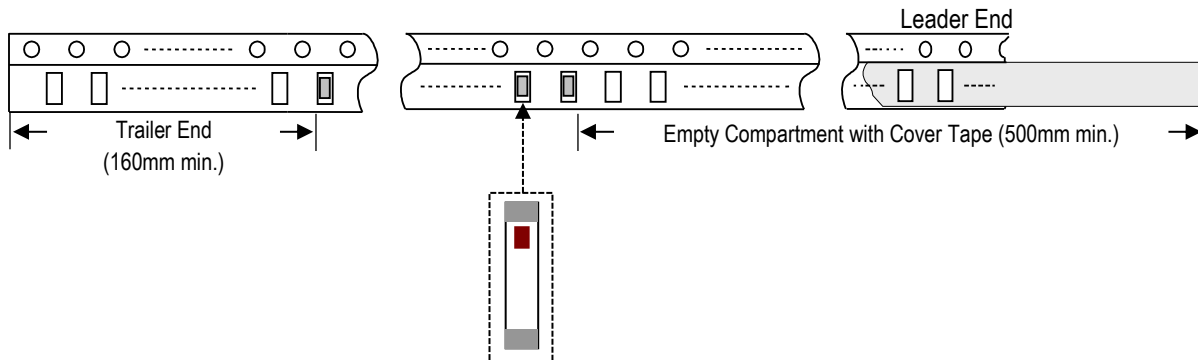

Orderable Part Number

Packaging Style	Part Number	Termination
Bulk (loose pcs.)	0900AD54B2450001B	Nickel Tin
T & R (7" Reel Embossed Tape)	0900AD54B2450001E (Qty: 500 pcs./reel)	
Evaluation Board with 1 SMA Connector	0900AD54B2450001CE1	

Important Links

[0900AD54B2450001E Product Page](#)

[More Chip Antennas](#)

[Antenna Tuning, Optimization, and Validation Services](#)

[Soldering Information](#)

[MSL Information](#)

[Packaging Information](#)

[Recommended Storage Condition and Max Shelf Life](#)

[RoHS Compliance](#)

Contact our application engineers for a PCB layout review

**Johanson Technology, Inc. reserves the right to make design changes without notice.
All sales are subject to Johanson Technology, Inc. terms and conditions.**