



# IHM06-06NPSVT0S

IMM

INDUCTIVE PROXIMITY SENSORS

**SICK**  
Sensor Intelligence.



Illustration may differ



### Ordering information

Type	Part no.
IHM06-06NPSVT05	1114155

Other models and accessories → [www.sick.com/IMM](http://www.sick.com/IMM)

### Detailed technical data

#### Features

<b>Housing</b>	Cylindrical smooth housing
<b>Housing</b>	Standard design
<b>Diameter</b>	Ø 6.5 mm
<b>Sensing range <math>S_n</math></b>	6 mm
<b>Safe sensing range <math>S_a</math></b>	4.86 mm
<b>Installation type</b>	Non-flush
<b>Switching frequency</b>	1,000 Hz
<b>Connection type</b>	Connector M8, 3-pin
<b>Switching output</b>	PNP
<b>Output function</b>	NO
<b>Electrical wiring</b>	DC 3-wire
<b>Enclosure rating</b>	IP67 <sup>1)</sup>
<b>Special features</b>	Visual adjustment indicator, IO-Link, triple sensing range

<sup>1)</sup> According to EN 60529.

#### Mechanics/electronics

<b>Supply voltage</b>	10 V DC ... 30 V DC
<b>Ripple</b>	≤ 20 % <sup>1)</sup>
<b>Voltage drop</b>	≤ 2 V <sup>2)</sup>
<b>Time delay before availability</b>	≤ 80 ms

<sup>1)</sup> Of  $V_S$ .

<sup>2)</sup> With  $I_a = 200$  mA.

<sup>3)</sup> Supply voltage  $U_b$  and constant ambient temperature  $T_a$ .

<b>Hysteresis</b>	1 % ... 10 %
<b>Reproducibility</b>	≤ 2 % <sup>3)</sup>
<b>Temperature drift (of S<sub>r</sub>)</b>	≤ 10 %
<b>EMC</b>	EN 60947-5-2
<b>Continuous current I<sub>a</sub></b>	≤ 200 mA
<b>Short-circuit protection</b>	✓
<b>Reverse polarity protection</b>	✓
<b>Power-up pulse protection</b>	✓
<b>Shock and vibration resistance</b>	30 g, 11 ms / 10 ... 55 Hz, 1 mm
<b>Ambient operating temperature</b>	-25 °C ... +70 °C
<b>Housing material</b>	Stainless steel V2A, DIN 1.4305 / AISI 303
<b>Sensing face material</b>	Plastic, LCP
<b>Housing length</b>	50 mm
<b>UL File No.</b>	NRKH.E348498

<sup>1)</sup> Of V<sub>S</sub>.

<sup>2)</sup> With I<sub>a</sub> = 200 mA.

<sup>3)</sup> Supply voltage U<sub>b</sub> and constant ambient temperature T<sub>a</sub>.

#### Safety-related parameters

<b>MTTF<sub>D</sub></b>	1,330 years
<b>DC<sub>avg</sub></b>	0 %

#### Communication interface

<b>Communication interface</b>	IO-Link V1.1
<b>Communication Interface detail</b>	COM2 (38,4 kBaud)
<b>Cycle time</b>	10.4 ms
<b>Process data length</b>	1 Byte
<b>Process data structure</b>	Bit 0 = Sr reached Bit 1 = Sa reached

#### Reduction factors

<b>Note</b>	The values are reference values which may vary
<b>St37 steel (Fe)</b>	1
<b>Stainless steel (V2A, 304)</b>	Approx. 0.75
<b>Aluminum (Al)</b>	Approx. 0.5
<b>Copper (Cu)</b>	Approx. 0.43
<b>Brass (Br)</b>	Approx. 0.54

#### Installation note

<b>Remark</b>	Associated graphic see "Installation"
<b>A</b>	12 mm
<b>B</b>	35 mm
<b>C</b>	6.5 mm
<b>D</b>	18 mm
<b>E</b>	12 mm

<b>F</b>	48 mm
----------	-------

Classifications

<b>eCl@ss 5.0</b>	27270101
<b>eCl@ss 5.1.4</b>	27270101
<b>eCl@ss 6.0</b>	27270101
<b>eCl@ss 6.2</b>	27270101
<b>eCl@ss 7.0</b>	27270101
<b>eCl@ss 8.0</b>	27270101
<b>eCl@ss 8.1</b>	27270101
<b>eCl@ss 9.0</b>	27270101
<b>eCl@ss 10.0</b>	27270101
<b>eCl@ss 11.0</b>	27270101
<b>eCl@ss 12.0</b>	27274001
<b>ETIM 5.0</b>	EC002714
<b>ETIM 6.0</b>	EC002714
<b>ETIM 7.0</b>	EC002714
<b>ETIM 8.0</b>	EC002714
<b>UNSPSC 16.0901</b>	39122230

Adjustments

Installation aid

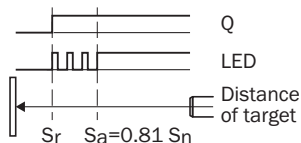

Installation note

Non-flush installation

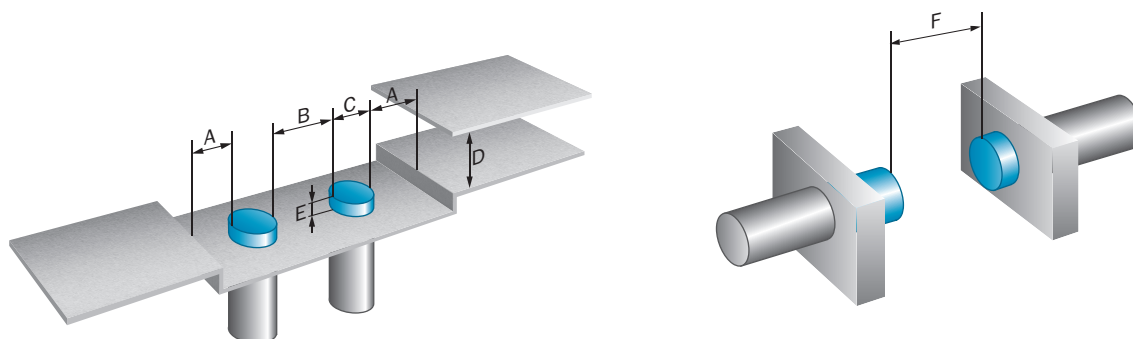

Mounting using BEF-KH-M0 bracket

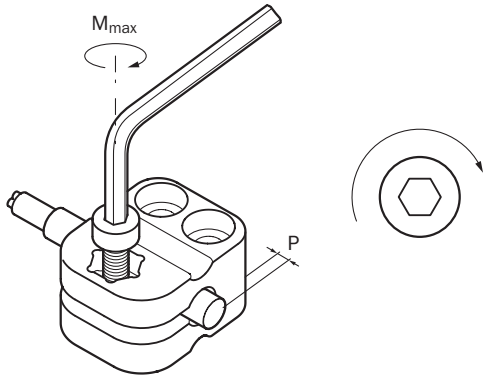

Sensor type	Mounting adapter	Overrun (P)	Max. tightening torque ( $M_{max}$ )
IHM03	BEF-KH-M03, part no. 2101064	0 mm ... 2 mm / $\geq 2$ mm	$\leq 0.4$ Nm / $\leq 0.6$ Nm
IHM04	BEF-KH-M04, part no. 2101065	0 mm ... 2 mm / $\geq 2$ mm	$\leq 0.4$ Nm / $\leq 0.6$ Nm
IMM04	BEF-KH-M04, part no. 2101065	$\geq 0$ mm	$\leq 0.6$ Nm
IMM05	BEF-KH-M05, part no. 2101066	$\geq 0$ mm	$\leq 0.6$ Nm
IHM06 flush	BEF-KH-M06, part no. 2101067	$\geq 0$ mm	$\leq 0.6$ Nm
IHM06 non-flush	BEF-KH-M06, part no. 2101067	$\geq 4$ mm	$\leq 0.6$ Nm

Fixing with setscrew

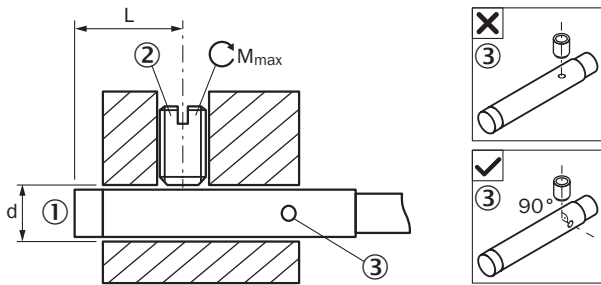

- ① Sensing face
- ② Recommended setscrew: M3, flat point
- ③ Display LED

IHM06 non-flush	Mounting area (L)	Max. tightening torque ( $M_{max}$ )	Diameter of mounting hole (d)
IHM06-04N*****K	8 mm ... 21 mm	$\leq 0.4$ Nm	$\varnothing 6.5$ mm ... $\varnothing 6.8$ mm
IHM06-04N***TOK	8 mm ... 32 mm	$\leq 0.4$ Nm	$\varnothing 6.5$ mm ... $\varnothing 6.8$ mm
IHM06-04N*****S	8 mm ... 32 mm	$\leq 0.4$ Nm	$\varnothing 6.5$ mm ... $\varnothing 6.8$ mm
IHM06-04N***TOS	8 mm ... 42 mm	$\leq 0.4$ Nm	$\varnothing 6.5$ mm ... $\varnothing 6.8$ mm
IHM06-06N*****K	12 mm ... 21 mm	$\leq 0.4$ Nm	$\varnothing 6.5$ mm ... $\varnothing 6.8$ mm
IHM06-06N***TOK	12 mm ... 32 mm	$\leq 0.4$ Nm	$\varnothing 6.5$ mm ... $\varnothing 6.8$ mm
IHM06-06N*****S	12 mm ... 32 mm	$\leq 0.4$ Nm	$\varnothing 6.5$ mm ... $\varnothing 6.8$ mm
IHM06-06N***TOS	12 mm ... 42 mm	$\leq 0.4$ Nm	$\varnothing 6.5$ mm ... $\varnothing 6.8$ mm

**Connection diagram**

Cd-002

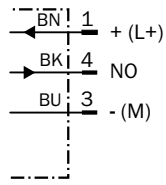

**Response diagram**

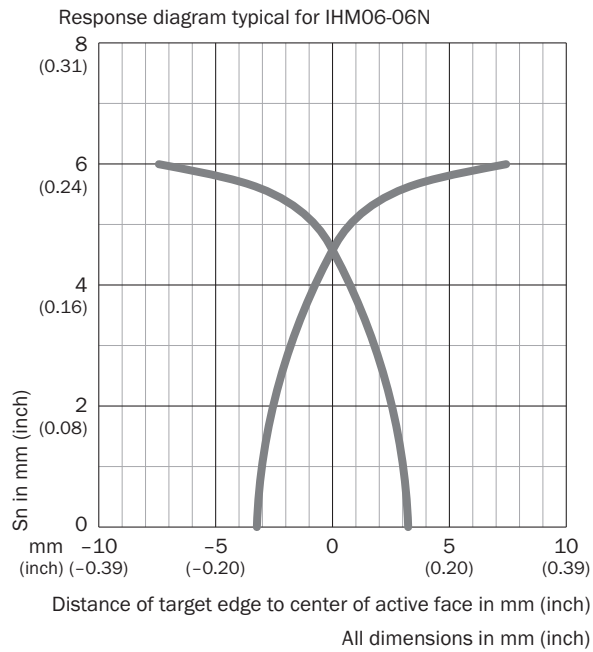

**Dimensional drawing** (Dimensions in mm (inch))



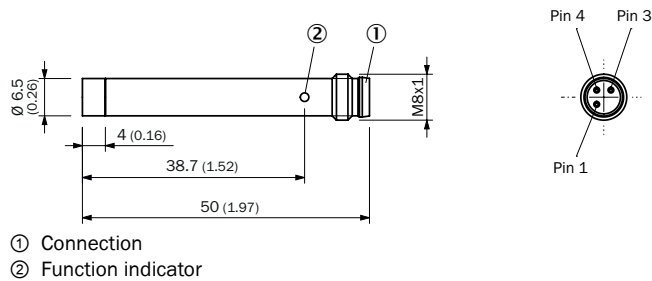





IHM06, standard variant, non-flush, male connector



## Recommended accessories

Other models and accessories → [www.sick.com/IMM](http://www.sick.com/IMM)

	Brief description	Type	Part no.
<b>Distributors</b>			
	Head A: 3-pin Cable: unshielded	Y8A34A2- C2A8000XXX	2115733
	Head A: 3-pin Cable: PUR, halogen-free, unshielded, 5 m	Y8A34A2- LXXXUAA050	2115727
	Head A: 3-pin Cable: unshielded	Y8A36A2- C2A8000XXX	2115734
	Head A: 3-pin Cable: PUR, halogen-free, unshielded, 5 m	Y8A36A2- LXXXUBA050	2115728
<b>Plug connectors and cables</b>			
	Head A: female connector, M8, 3-pin, straight, A-coded Head B: Flying leads Cable: Sensor/actuator cable, PUR, halogen-free, unshielded, 2 m	YF8U13- 020UA1XLEAX	2094782
	Head A: female connector, M8, 3-pin, straight, A-coded Head B: Flying leads Cable: Sensor/actuator cable, PVC, unshielded, 2 m	YF8U13- 020VA1XLEAX	2095860
	Head A: female connector, M8, 3-pin, straight, A-coded Head B: Flying leads Cable: Sensor/actuator cable, PUR, halogen-free, unshielded, 5 m	YF8U13- 050UA1XLEAX	2094788
	Head A: female connector, M8, 3-pin, straight, A-coded Head B: Flying leads Cable: Sensor/actuator cable, PVC, unshielded, 5 m	YF8U13- 050VA1XLEAX	2095884
	Head A: female connector, M8, 3-pin, angled, A-coded Head B: Flying leads Cable: Sensor/actuator cable, PUR, halogen-free, unshielded, 2 m	YG8U13- 020UA1XLEAX	2094794
	Head A: female connector, M8, 3-pin, angled, A-coded Head B: Flying leads Cable: Sensor/actuator cable, PVC, unshielded, 2 m	YG8U13- 020VA1XLEAX	2096165
	Head A: female connector, M8, 3-pin, angled, A-coded Head B: Flying leads Cable: Sensor/actuator cable, PUR, halogen-free, unshielded, 5 m	YG8U13- 050UA1XLEAX	2095586
	Head A: female connector, M8, 3-pin, angled, A-coded Head B: Flying leads Cable: Sensor/actuator cable, PVC, unshielded, 5 m	YG8U13- 050VA1XLEAX	2096166
	Head A: female connector, M8, 3-pin, straight, A-coded Head B: male connector, M12, 3-pin, straight, A-coded Cable: Sensor/actuator cable, PUR, halogen-free, unshielded, 2 m	YF8U13- 020UA1M2A13	2096169
	Head A: female connector, M8, 3-pin, straight, A-coded Head B: male connector, M8, 3-pin, straight, A-coded Cable: Sensor/actuator cable, PUR, halogen-free, unshielded, 2 m	YF8U13- 020UA1M8U13	2096304
	Head A: female connector, M8, 3-pin, straight, A-coded Head B: male connector, M12, 3-pin, straight, A-coded Cable: Sensor/actuator cable, PVC, unshielded, 2 m	YF8U13- 020VA1M2A13	2096605

	<b>Brief description</b>	<b>Type</b>	<b>Part no.</b>
	Head A: female connector, M8, 3-pin, straight, A-coded Head B: male connector, M12, 3-pin, straight, A-coded Cable: Sensor/actuator cable, PUR, halogen-free, unshielded, 5 m	YF8U13-050UA1M2A13	2096170
	Head A: female connector, M8, 3-pin, straight, A-coded Head B: male connector, M8, 3-pin, straight, A-coded Cable: Sensor/actuator cable, PUR, halogen-free, unshielded, 5 m	YF8U13-050UA1M8U13	2096308
	Head A: female connector, M8, 3-pin, straight, A-coded Head B: male connector, M12, 3-pin, straight, A-coded Cable: Sensor/actuator cable, PVC, unshielded, 5 m	YF8U13-050VA1M2A13	2096606
	Head A: female connector, M8, 3-pin, angled, A-coded Head B: male connector, M12, 3-pin, straight, A-coded Cable: Sensor/actuator cable, PUR, halogen-free, unshielded, 2 m	YG8U13-020UA1M2A13	2095748
	Head A: female connector, M8, 3-pin, angled, A-coded Head B: male connector, M8, 3-pin, straight, A-coded Cable: Sensor/actuator cable, PUR, halogen-free, unshielded, 2 m	YG8U13-020UA1M8U13	2107781
	Head A: female connector, M8, 3-pin, angled, A-coded Head B: male connector, M12, 3-pin, straight, A-coded Cable: Sensor/actuator cable, PUR, halogen-free, unshielded, 5 m	YG8U13-050UA1M2A13	2122842
	Head A: male connector, M8, 3-pin, straight Cable: unshielded	STE-0803-G	6037322
	Head A: male connector, M8, 3-pin, angled Cable: unshielded	STE-0803-WSK	6053170
<b>Terminal and alignment brackets</b>			
	Plastic (PA6), without mounting hardware	BEF-KH-M06	2101067



## SICK AT A GLANCE

SICK is one of the leading manufacturers of intelligent sensors and sensor solutions for industrial applications. A unique range of products and services creates the perfect basis for controlling processes securely and efficiently, protecting individuals from accidents and preventing damage to the environment.

We have extensive experience in a wide range of industries and understand their processes and requirements. With intelligent sensors, we can deliver exactly what our customers need. In application centers in Europe, Asia and North America, system solutions are tested and optimized in accordance with customer specifications. All this makes us a reliable supplier and development partner.

Comprehensive services complete our offering: SICK LifeTime Services provide support throughout the machine life cycle and ensure safety and productivity.

For us, that is “Sensor Intelligence.”

## WORLDWIDE PRESENCE:

Contacts and other locations –[www.sick.com](http://www.sick.com)