



IM12-02BPO-ZC1

IM Standard

INDUCTIVE PROXIMITY SENSORS

SICK
Sensor Intelligence.



Ordering information

| Type | Part no. |
|----------------|----------|
| IM12-02BPO-ZC1 | 6011973 |

Other models and accessories → www.sick.com/IM_Standard

Illustration may differ



Detailed technical data

Features

| | |
|---------------------------------------|---------------------------|
| Housing | Cylindrical thread design |
| Housing | Standard design |
| Thread size | M12 x 1 |
| Diameter | Ø 12 mm |
| Sensing range S_n | 2 mm |
| Installation type | Flush |
| Switching frequency | 2,000 Hz |
| Connection type | Male connector M12, 4-pin |
| Switching output | PNP |
| Output function | NC |
| Electrical wiring | DC 3-wire |
| Enclosure rating | IP67 ¹⁾ |

¹⁾ According to EN 60529.

Mechanics/electronics

| | |
|---------------------------------------|-----------------------|
| Supply voltage | 10 V DC ... 30 V DC |
| Ripple | ≤ 10 % ¹⁾ |
| Voltage drop | ≤ 1.2 V ²⁾ |
| Time delay before availability | ≤ 100 ms |
| Hysteresis | 2 % ... 10 % |

¹⁾ Of V_S .

²⁾ At I_a max.

³⁾ Supply voltage U_b and constant ambient temperature T_a .

⁴⁾ Of S_r .

| | |
|---|----------------------------------|
| Reproducibility | ≤ 2 % ^{3) 4)} |
| Temperature drift (of S_r) | ± 10 % |
| EMC | According to EN 60947-5-2 |
| Continuous current I_a | ≤ 200 mA |
| Short-circuit protection | ✓ |
| Reverse polarity protection | ✓ |
| Power-up pulse protection | ✓ |
| Shock and vibration resistance | 30 g, 11 ms / 10 ... 55 Hz, 1 mm |
| Ambient operating temperature | -25 °C ... +70 °C |
| Housing material | Brass, Nickel-plated brass |
| Sensing face material | Plastic |
| Housing length | 65 mm |
| Thread length | 43 mm |
| Tightening torque, max. | ≤ 10 Nm |

1) Of V_S.

2) At I_a max.

3) Supply voltage U_b and constant ambient temperature T_a.

4) Of S_r.

Safety-related parameters

| | |
|-------------------------|-----------|
| MTTF_D | 192 years |
| DC_{avg} | 0 % |

Installation note

| | |
|---------------|---------------------------------------|
| Remark | Associated graphic see "Installation" |
| A | 6 mm |
| B | 12 mm |
| C | 12 mm |
| D | 6 mm |
| E | 0 mm |
| F | 16 mm |

Classifications

| | |
|---------------------|----------|
| eCl@ss 5.0 | 27270101 |
| eCl@ss 5.1.4 | 27270101 |
| eCl@ss 6.0 | 27270101 |
| eCl@ss 6.2 | 27270101 |
| eCl@ss 7.0 | 27270101 |
| eCl@ss 8.0 | 27270101 |
| eCl@ss 8.1 | 27270101 |
| eCl@ss 9.0 | 27270101 |
| eCl@ss 10.0 | 27270101 |
| eCl@ss 11.0 | 27270101 |
| eCl@ss 12.0 | 27274001 |

| | |
|-----------------------|----------|
| ETIM 5.0 | EC002714 |
| ETIM 6.0 | EC002714 |
| ETIM 7.0 | EC002714 |
| ETIM 8.0 | EC002714 |
| UNSPSC 16.0901 | 39122230 |

Installation note

Non-flush installation

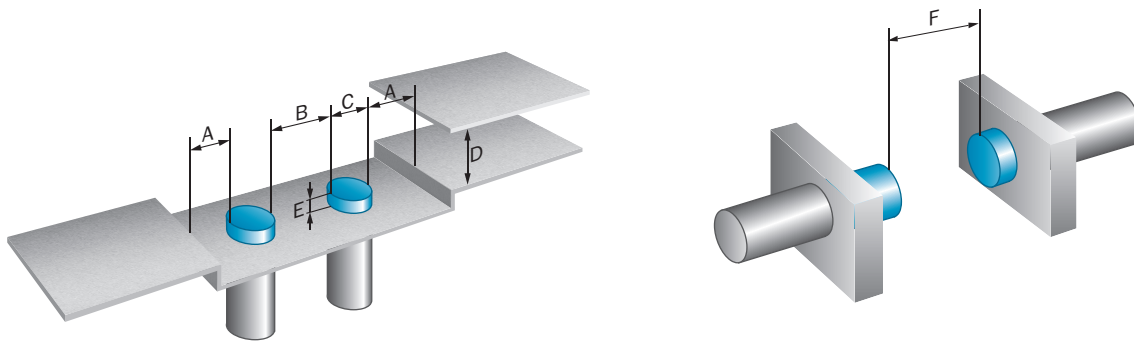

Connection type

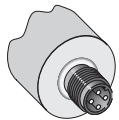

Connection diagram

Cd-008

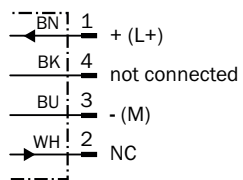

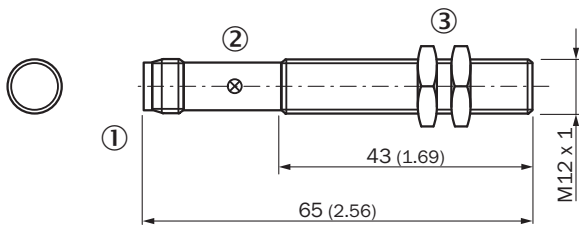









Dimensional drawing (Dimensions in mm (inch))

- ① Connection
- ② Display LED
- ③ Fastening nuts (2x); width across 17, metal

Recommended accessories

 Other models and accessories → www.sick.com/IM_Standard

| | Brief description | Type | Part no. |
|---|--|--------------------|----------|
| Mounting brackets and plates | | | |
|  | Mounting plate for M12 sensors, steel, zinc coated, without mounting hardware | BEF-WG-M12 | 5321869 |
|  | Mounting bracket for M12 sensors, steel, zinc coated, without mounting hardware | BEF-WN-M12 | 5308447 |
| Plug connectors and cables | | | |
|  | Head A: female connector, M12, 4-pin, straight, A-coded Head B: Flying leads Cable: Sensor/actuator cable, PVC, unshielded, 2 m | YF2A14-020VB3XLEAX | 2096234 |
| | Head A: female connector, M12, 4-pin, straight, A-coded Head B: Flying leads Cable: Sensor/actuator cable, PVC, unshielded, 5 m | YF2A14-050VB3XLEAX | 2096235 |
|  | Head A: female connector, M12, 4-pin, angled, A-coded Head B: Flying leads Cable: Sensor/actuator cable, PVC, unshielded, 2 m | YG2A14-020VB3XLEAX | 2095895 |
| | Head A: female connector, M12, 4-pin, angled, A-coded Head B: Flying leads Cable: Sensor/actuator cable, PVC, unshielded, 5 m | YG2A14-050VB3XLEAX | 2095897 |
|  | Head A: female connector, M12, 4-pin, angled, A-coded Head B: Flying leads Cable: Sensor/actuator cable, PVC, unshielded, 2 m Only suitable for PNP sensors | YI2A14-020VB3XLEAX | 2096222 |
| | Head A: female connector, M12, 4-pin, angled, A-coded Head B: Flying leads Cable: Sensor/actuator cable, PVC, unshielded, 5 m Only suitable for PNP sensors | YI2A14-050VB3XLEAX | 2096223 |
|  | Head A: female connector, M12, 4-pin, straight Cable: unshielded | DOS-1204-G | 6007302 |
|  | Head A: female connector, M12, 4-pin, angled Cable: unshielded | DOS-1204-W | 6007303 |

| | Brief description | Type | Part no. |
|---|--|-------------|----------|
|  | Head A: male connector, M12, 4-pin, straight Cable: unshielded | STE-1204-G | 6009932 |
|  | Head A: male connector, M12, 4-pin, angled Cable: unshielded | STE-1204-W | 6022084 |
| Terminal and alignment brackets | | | |
|  | Clamping block for round sensors M12, without fixed stop, plastic (PA12), glass-fiber reinforced, mounting hardware included | BEF-KH-M12 | 2051479 |
| | Clamping block for round sensors M12, with fixed stop, plastic (PA12), glass-fiber reinforced, mounting hardware included | BEF-KHF-M12 | 2051480 |

SICK AT A GLANCE

SICK is one of the leading manufacturers of intelligent sensors and sensor solutions for industrial applications. A unique range of products and services creates the perfect basis for controlling processes securely and efficiently, protecting individuals from accidents and preventing damage to the environment.

We have extensive experience in a wide range of industries and understand their processes and requirements. With intelligent sensors, we can deliver exactly what our customers need. In application centers in Europe, Asia and North America, system solutions are tested and optimized in accordance with customer specifications. All this makes us a reliable supplier and development partner.

Comprehensive services complete our offering: SICK LifeTime Services provide support throughout the machine life cycle and ensure safety and productivity.

For us, that is “Sensor Intelligence.”

WORLDWIDE PRESENCE:

Contacts and other locations –www.sick.com