



IMB08-04NNSVT0K

IMB

INDUCTIVE PROXIMITY SENSORS

SICK
Sensor Intelligence.



Illustration may differ



Ordering information

Type	Part no.
IMB08-04NNSVTOK	1070169

Included in delivery: BEF-MU-M08N (1)

Other models and accessories → www.sick.com/IMB

Detailed technical data

Features

Housing	Cylindrical thread design
Housing	Short-body
Thread size	M8 x 1
Diameter	Ø 8 mm
Sensing range S_n	4 mm
Safe sensing range S_a	3.24 mm
Installation type	Non-flush
Switching frequency	4,000 Hz
Connection type	Connector M8, 3-pin ¹⁾
Switching output	NPN
Output function	NO
Electrical wiring	DC 3-wire
Enclosure rating	IP68 ²⁾ IP69K ³⁾
Special features	Resistant against coolant lubricants, Visual adjustment indicator, Temperature resistance
Special applications	Zones with coolants and lubricants, Mobile machines, Difficult application conditions
Items supplied	Mounting nut, V2A stainless steel, with locking teeth (2x)

¹⁾ With gold plated contact pins.

²⁾ According to EN 60529.

³⁾ According to ISO 20653:2013-03.

Mechanics/electronics

Supply voltage	10 V DC ... 30 V DC
Ripple	≤ 10 %
Voltage drop	≤ 2 V ¹⁾
Hysteresis	3 % ... 20 %
Reproducibility	≤ 2 % ^{2) 3)}
Temperature drift (of S_r)	± 10 %
EMC	According to EN 60947-5-2
Continuous current I_a	≤ 200 mA
No load current	≤ 10 mA
Short-circuit protection	✓
Reverse polarity protection	✓
Power-up pulse protection	✓
Shock and vibration resistance	100 g / 11 ms / 1000 cycles; 150 g / 1 Mio cycles; 10 Hz ... 55 Hz, 1 mm / 55 Hz ... 500 Hz / 15 g
Ambient operating temperature	-40 °C ... +100 °C
Housing material	Stainless steel V2A, DIN 1.4305 / AISI 303
Sensing face material	Plastic, LCP
Housing length	40 mm
Thread length	24 mm
Tightening torque, max.	Typ. 7 Nm ⁴⁾ Typ. 14 Nm ⁵⁾
Protection class	III
UL File No.	E181493

¹⁾ At I_a max.

²⁾ Supply voltage U_b and constant ambient temperature T_a.

³⁾ Of S_r.

⁴⁾ When using the non-toothed side of the nut.

⁵⁾ Valid if toothed side of nut is used.

Safety-related parameters

MTTF_D	1,971 years
DC_{avg}	0 %

Reduction factors

Note	The values are reference values which may vary
St37 steel (Fe)	1
Stainless steel (V2A, 304)	Approx. 0.69
Aluminum (Al)	Approx. 0.37
Copper (Cu)	Approx. 0.28
Brass (Br)	Approx. 0.4

Installation note

Remark	Associated graphic see "Installation"
A	8 mm

B	18 mm
C	8 mm
D	12 mm
E	8 mm
F	32 mm

Classifications

ECLASS 5.0	27270101
ECLASS 5.1.4	27270101
ECLASS 6.0	27270101
ECLASS 6.2	27270101
ECLASS 7.0	27270101
ECLASS 8.0	27270101
ECLASS 8.1	27270101
ECLASS 9.0	27270101
ECLASS 10.0	27270101
ECLASS 11.0	27270101
ECLASS 12.0	27274001
ETIM 5.0	EC002714
ETIM 6.0	EC002714
ETIM 7.0	EC002714
ETIM 8.0	EC002714
UNSPSC 16.0901	39122230

Adjustments

Installation aid

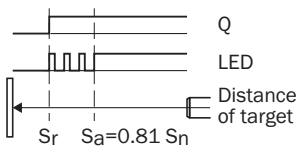

Installation note

Non-flush installation



Connection diagram

Cd-002

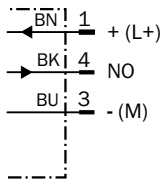

Response diagram

Response diagram

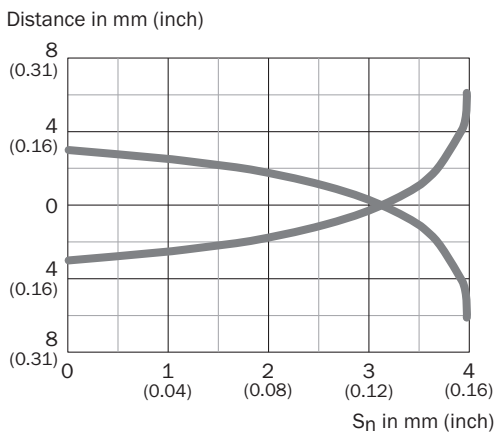

Dimensional drawing (Dimensions in mm (inch))

IMB08 Short-body housing, connector M8, non-flush

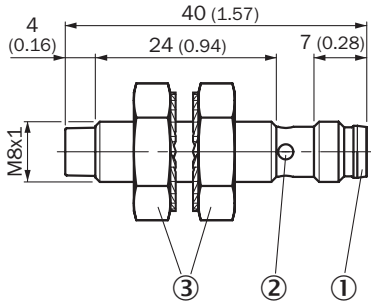





- ① Connection
- ② Display LED
- ③ Fastening nuts (2 x); width across 13, stainless steel V2A

Recommended accessories

Other models and accessories → www.sick.com/IMB

	Brief description	Type	Part no.
Mounting brackets and plates			
	Mounting plate for M8 sensors, steel, zinc coated, without mounting hardware	BEF-WG-M08	5321722
	Mounting bracket for M8 sensors, steel, zinc coated, without mounting hardware	BEF-WN-M08	5321721
Plug connectors and cables			
	Head A: female connector, M8, 3-pin, straight Head B: Flying leads Cable: Sensor/actuator cable, PP, unshielded, 2 m This product is generally resistant to chemical cleaning agents (see ECOLAB) and other chemical compounds such as H2O2 and CH2O2. Before permanent installation is carried out, the material's resistance to the cleaning agent being used must be checked., Resistant against lactic acid & hydrogen peroxide (H2O2)	DOL-0803-G02MRN	6058504
	Head A: female connector, M8, 3-pin, straight Head B: Flying leads Cable: Sensor/actuator cable, PP, unshielded, 5 m This product is generally resistant to chemical cleaning agents (see ECOLAB) and other chemical compounds such as H2O2 and CH2O2. Before permanent installation is carried out, the material's resistance to the cleaning agent being used must be checked., Resistant against lactic acid & hydrogen peroxide (H2O2)	DOL-0803-G05MRN	6058505
	Head A: female connector, M8, 3-pin, angled Head B: Flying leads Cable: Sensor/actuator cable, PP, unshielded, 2 m This product is generally resistant to chemical cleaning agents (see ECOLAB) and other chemical compounds such as H2O2 and CH2O2. Before permanent installation is carried out, the material's resistance to the cleaning agent being used must be checked., Resistant against lactic acid & hydrogen peroxide (H2O2), only suitable for PNP sensors	DOL-0803-L02MRN	6058787

	Brief description	Type	Part no.
	Head A: female connector, M8, 3-pin, angled Head B: Flying leads Cable: Sensor/actuator cable, PP, unshielded, 5 m This product is generally resistant to chemical cleaning agents (see ECOLAB) and other chemical compounds such as H2O2 and CH2O2. Before permanent installation is carried out, the material's resistance to the cleaning agent being used must be checked.	DOL-0803-L05MRN	6058788
	Head A: female connector, M8, 3-pin, angled Head B: Flying leads Cable: Sensor/actuator cable, PP, unshielded, 2 m This product is generally resistant to chemical cleaning agents (see ECOLAB) and other chemical compounds such as H2O2 and CH2O2. Before permanent installation is carried out, the material's resistance to the cleaning agent being used must be checked., Resistant against lactic acid & hydrogen peroxide (H2O2)	DOL-0803-W02MRN	6058507
	Head A: female connector, M8, 3-pin, angled Head B: Flying leads Cable: Sensor/actuator cable, PP, unshielded, 5 m This product is generally resistant to chemical cleaning agents (see ECOLAB) and other chemical compounds such as H2O2 and CH2O2. Before permanent installation is carried out, the material's resistance to the cleaning agent being used must be checked.	DOL-0803-W05MRN	6058508
	Head A: female connector, M8, 3-pin, straight, A-coded Head B: Flying leads Cable: Sensor/actuator cable, PUR, halogen-free, unshielded, 1 m	YF8U13-010UA1XLEAX	2094779
	Head A: female connector, M8, 3-pin, straight, A-coded Head B: Flying leads Cable: Sensor/actuator cable, PUR, halogen-free, unshielded, 2 m	YF8U13-020UA1XLEAX	2094782
	Head A: female connector, M8, 3-pin, straight, A-coded Head B: Flying leads Cable: Sensor/actuator cable, PUR, halogen-free, unshielded, 3 m	YF8U13-030UA1XLEAX	2094787
	Head A: female connector, M8, 3-pin, straight, A-coded Head B: Flying leads Cable: Sensor/actuator cable, PUR, halogen-free, unshielded, 5 m	YF8U13-050UA1XLEAX	2094788
	Head A: female connector, M8, 3-pin, straight, A-coded Head B: Flying leads Cable: Sensor/actuator cable, PUR, halogen-free, unshielded, 10 m	YF8U13-100UA1XLEAX	2094789
	Head A: female connector, M8, 3-pin, straight, A-coded Head B: Flying leads Cable: Sensor/actuator cable, PUR, halogen-free, unshielded, 20 m	YF8U13-200UA1XLEAX	2094790
	Head A: female connector, M8, 3-pin, straight, A-coded Head B: Flying leads Cable: Sensor/actuator cable, PUR, halogen-free, unshielded, 5 m	YF8U13-050UA1XLEAX	2094788
	Head A: female connector, M8, 3-pin, angled, A-coded Head B: Flying leads Cable: Sensor/actuator cable, PUR, halogen-free, unshielded, 2 m	YG8U13-020UA1XLEAX	2094794
	Head A: female connector, M8, 3-pin, angled, A-coded Head B: Flying leads Cable: Sensor/actuator cable, PUR, halogen-free, unshielded, 5 m	YG8U13-050UA1XLEAX	2095586
	Head A: female connector, M8, 3-pin, angled, A-coded Head B: Flying leads Cable: Sensor/actuator cable, PUR, halogen-free, unshielded, 10 m	YG8U13-100UA1XLEAX	2095588
	Head A: female connector, M8, 3-pin, angled, A-coded Head B: Flying leads Cable: Sensor/actuator cable, PUR, halogen-free, unshielded, 2 m Only suitable for PNP sensors	YI8U13-020UA1XLEAX	2095593
	Head A: female connector, M8, 3-pin, angled, A-coded Head B: Flying leads Cable: Sensor/actuator cable, PUR, halogen-free, unshielded, 10 m Only suitable for PNP sensors	YI8U13-100UA1XLEAX	2095595
	Head A: female connector, M8, 3-pin, straight, A-coded Head B: male connector, M8, 3-pin, straight, A-coded Cable: Sensor/actuator cable, PUR, halogen-free, unshielded, 2 m	YF8U13-020UA1M8U13	2096304

	Brief description	Type	Part no.
	Head A: female connector, M8, 3-pin, straight, A-coded Head B: male connector, M8, 3-pin, straight, A-coded Cable: Sensor/actuator cable, PUR, halogen-free, unshielded, 5 m	YF8U13-050UA1M8U13	2096308
	Head A: female connector, M8, 3-pin, straight, A-coded Head B: male connector, M8, 3-pin, straight, A-coded Cable: Sensor/actuator cable, PUR, halogen-free, unshielded, 10 m	YF8U13-100UA1M8U13	2096309
	Head A: female connector, M8, 3-pin, straight, A-coded Head B: male connector, M8, 3-pin, straight, A-coded Cable: Sensor/actuator cable, PUR, halogen-free, unshielded, 20 m	YF8U13-200UA1M8U13	2096310

SICK AT A GLANCE

SICK is one of the leading manufacturers of intelligent sensors and sensor solutions for industrial applications. A unique range of products and services creates the perfect basis for controlling processes securely and efficiently, protecting individuals from accidents and preventing damage to the environment.

We have extensive experience in a wide range of industries and understand their processes and requirements. With intelligent sensors, we can deliver exactly what our customers need. In application centers in Europe, Asia and North America, system solutions are tested and optimized in accordance with customer specifications. All this makes us a reliable supplier and development partner.

Comprehensive services complete our offering: SICK LifeTime Services provide support throughout the machine life cycle and ensure safety and productivity.

For us, that is “Sensor Intelligence.”

WORLDWIDE PRESENCE:

Contacts and other locations –www.sick.com