



IMM05-1B5POVU2SS02

IMM

INDUCTIVE PROXIMITY SENSORS

SICK
Sensor Intelligence.



Ordering information

Type	Part no.
IMM05-1B5POVU2SS02	1119900

Other models and accessories → www.sick.com/IMM

Illustration may differ



Detailed technical data

Features

Housing	Cylindrical thread design
Housing	Standard design
Thread size	M5 x 0.5
Diameter	Ø 5 mm
Sensing range S_n	1.5 mm
Safe sensing range S_a	1.215 mm
Installation type	Flush
Switching frequency	4,800 Hz
Connection type	Cable, 3-wire, 2 m
Switching output	PNP
Output function	NC
Electrical wiring	DC 3-wire
Enclosure rating	IP67 ¹⁾
Special features	Visual adjustment indicator
Items supplied	Mounting nut, V2A stainless steel (2x) Washer, V2A stainless steel, with locking teeth (2x) Cable flag, Polymatic 50 (1 x)

¹⁾ According to EN 60529.

Mechanics/electronics

Supply voltage	10 V DC ... 30 V DC
Ripple	≤ 20 % ¹⁾
Voltage drop	≤ 2 V ²⁾
Time delay before availability	≤ 10 ms
Hysteresis	1 % ... 15 %

¹⁾ Of V_S .

²⁾ With $I_a = 200$ mA.

³⁾ Supply voltage U_b and constant ambient temperature T_a .

Reproducibility	≤ 2.5 % ³⁾
Temperature drift (of S_r)	≤ 10 %
EMC	EN 60947-5-2
Continuous current I_a	≤ 200 mA
Cable material	PUR
Conductor size	0.14 mm ²
Cable diameter	Ø 2.9 mm
Short-circuit protection	✓
Reverse polarity protection	✓
Power-up pulse protection	✓
Shock and vibration resistance	30 g, 11 ms / 10 ... 55 Hz, 1 mm
Ambient operating temperature	-30 °C ... +70 °C
Housing material	Stainless steel V2A, DIN 1.4305 / AISI 303
Sensing face material	Plastic, LCP
Housing length	25 mm
Thread length	23 mm
Tightening torque, max.	≤ 1.5 Nm
UL File No.	NRKH.E348498

1) Of V_S.

2) With I_a = 200 mA.

3) Supply voltage U_b and constant ambient temperature T_a.

Safety-related parameters

MTTF_D	1,662 years
DC_{avg}	0 %

Reduction factors

Note	The values are reference values which may vary
St37 steel (Fe)	1
Stainless steel (V2A, 304)	Approx. 0.76
Aluminum (Al)	Approx. 0.47
Copper (Cu)	Approx. 0.4
Brass (Br)	Approx. 0.54

Installation note

Remark	Associated graphic see "Installation"
B	3 mm
C	5 mm
D	4.5 mm
F	5 mm

Classifications

eCl@ss 5.0	27270101
eCl@ss 5.1.4	27270101

eCl@ss 6.0	27270101
eCl@ss 6.2	27270101
eCl@ss 7.0	27270101
eCl@ss 8.0	27270101
eCl@ss 8.1	27270101
eCl@ss 9.0	27270101
eCl@ss 10.0	27270101
eCl@ss 11.0	27270101
eCl@ss 12.0	27274001
ETIM 5.0	EC002714
ETIM 6.0	EC002714
ETIM 7.0	EC002714
ETIM 8.0	EC002714
UNSPSC 16.0901	39122230

Adjustments

Installation aid

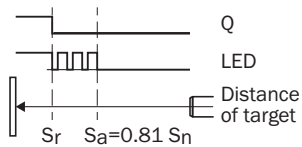

Installation note

Flush installation

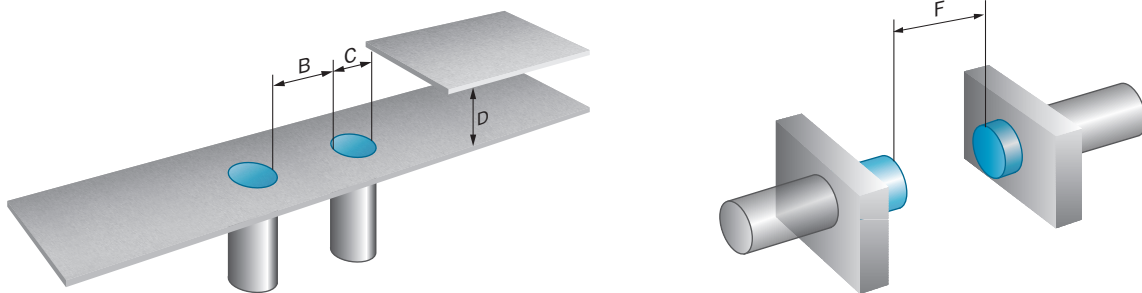

Mounting using BEF-KH-M0 bracket

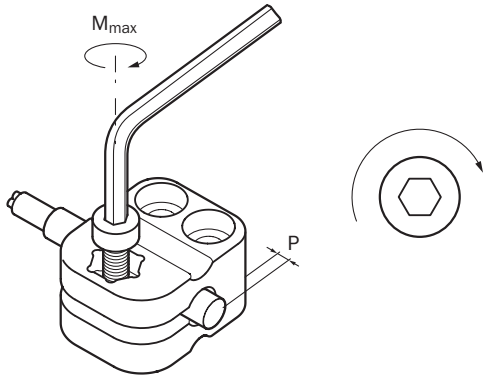

Sensor type	Mounting adapter	Overrun (P)	Max. tightening torque (M_{max})
IHM03	BEF-KH-M03, part no. 2101064	0 mm ... 2 mm / ≥ 2 mm	≤ 0.4 Nm / ≤ 0.6 Nm
IHM04	BEF-KH-M04, part no. 2101065	0 mm ... 2 mm / ≥ 2 mm	≤ 0.4 Nm / ≤ 0.6 Nm
IMM04	BEF-KH-M04, part no. 2101065	≥ 0 mm	≤ 0.6 Nm
IMM05	BEF-KH-M05, part no. 2101066	≥ 0 mm	≤ 0.6 Nm
IHM06 flush	BEF-KH-M06, part no. 2101067	≥ 0 mm	≤ 0.6 Nm
IHM06 non-flush	BEF-KH-M06, part no. 2101067	≥ 4 mm	≤ 0.6 Nm

Connection diagram

Cd-003

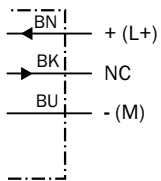

Response diagram

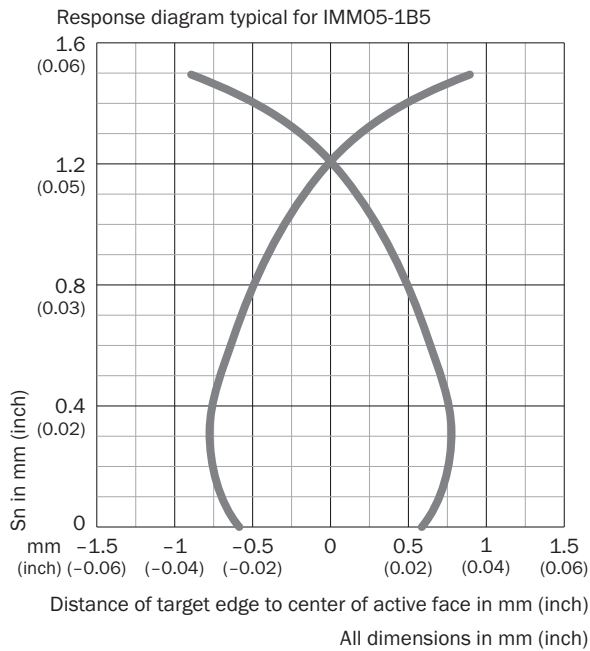

Dimensional drawing (Dimensions in mm (inch))

IMM05, standard variant, flush, cable

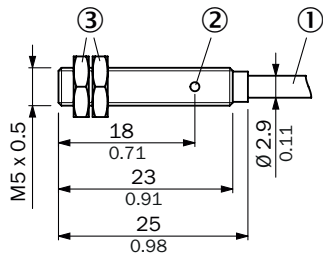







- ① Connection
- ② Function indicator
- ③ Fastening nuts (2 x); 8 mm hex, stainless steel

Recommended accessories

Other models and accessories → www.sick.com/IMM

	Brief description	Type	Part no.
Distributors			
	Head A: 3-pin Cable: unshielded	Y8A34A2- C2A8000XXX	2115733

	Brief description	Type	Part no.
	Head A: 3-pin Cable: PUR, halogen-free, unshielded, 5 m	Y8A34A2-LXXXUAA050	2115727
	Head A: 3-pin Cable: unshielded	Y8A36A2-C2A8000XXX	2115734
	Head A: 3-pin Cable: PUR, halogen-free, unshielded, 5 m	Y8A36A2-LXXXUBA050	2115728
Plug connectors and cables			
	Head A: male connector, M8, 3-pin, straight Cable: unshielded	STE-0803-G	6037322
	Head A: male connector, M8, 3-pin, angled Cable: unshielded	STE-0803-WSK	6053170
Terminal and alignment brackets			
	Plastic (PA6), without mounting hardware	BEF-KH-M05	2101066

SICK AT A GLANCE

SICK is one of the leading manufacturers of intelligent sensors and sensor solutions for industrial applications. A unique range of products and services creates the perfect basis for controlling processes securely and efficiently, protecting individuals from accidents and preventing damage to the environment.

We have extensive experience in a wide range of industries and understand their processes and requirements. With intelligent sensors, we can deliver exactly what our customers need. In application centers in Europe, Asia and North America, system solutions are tested and optimized in accordance with customer specifications. All this makes us a reliable supplier and development partner.

Comprehensive services complete our offering: SICK LifeTime Services provide support throughout the machine life cycle and ensure safety and productivity.

For us, that is “Sensor Intelligence.”

WORLDWIDE PRESENCE:

Contacts and other locations –www.sick.com