



HL18B-F4B3BH

H18 Sure Sense

HYBRID PHOTOELECTRIC SENSORS

SICK
Sensor Intelligence.

HL18B-F4B3BH | H18 Sure Sense

HYBRID PHOTOELECTRIC SENSORS



Illustration may differ



Ordering information

Type	Part no.
HL18B-F4B3BH	1101380

Other models and accessories → www.sick.com/H18_Sure_Sense

Detailed technical data

Features

Functional principle	Photoelectric retro-reflective sensor
Functional principle detail	Dual lens
Dimensions (W x H x D)	16.2 mm x 50.1 mm x 31.4 mm
Housing design (light emission)	Hybrid
Thread diameter (housing)	M18
Mounting system type	M18, head/M18, base/side (24.1 ... 25.4 mm)
Housing color	Blue
Sensing range max.	0.03 m ... 6.5 m ¹⁾
Sensing range	0.03 m ... 5 m ¹⁾
Type of light	Visible red light
Light source	PinPoint LED ²⁾
Light spot size (distance)	130 mm x 260 mm (6.5 m)
Wave length	631 nm
Adjustment	
	Potentiometer, right Sensitivity
	Potentiometer, left Light/dark switching
Special features	Signal strength light bar

¹⁾ Reflector PL80A.

²⁾ Average service life: 100,000 h at T_J = +25 °C.

Mechanics/electronics

Supply voltage	10 V DC ... 30 V DC
Ripple	$< 5 V_{pp}^{1)}$
Current consumption	$\leq 20 \text{ mA}^{2)}$
Switching output	Push-pull: PNP/NPN
Output function	Complementary
Switching mode	Light/dark switching
Switching output detail	
Switching output Q1	Push-pull: PNP/NPN, Light switching ³⁾
Switching output Q2	Push-pull: PNP/NPN, Dark switching ³⁾
Output current I_{max}	$\leq 100 \text{ mA}$
Response time	$\leq 0.5 \text{ ms}^{4)}$
Switching frequency	1,000 Hz ⁵⁾
Connection type	Cable with M12 male connector, 4-pin, 150 mm
Cable material	PVC
Conductor cross section	0.2 mm ²
Circuit protection	A ⁶⁾ B ⁷⁾ D ⁸⁾
Protection class	III
Weight	18 g
Polarisation filter	✓
Housing material	Plastic, VISTAL®
Optics material	Plastic, PMMA
Enclosure rating	IP67 IP69K
Items supplied	Fastening nut (1x), M18, plastic, black, flat
Electromagnetic compatibility (EMC)	EN 60947-5-2 (The sensor complies with the Radio Safety Requirements (EMC) for the industrial sector (Radio Safety Class A). It may cause radio interference if used in a residential area.)
Ambient operating temperature	-40 °C ... +70 °C
Ambient temperature, storage	-40 °C ... +75 °C
UL File No.	E189383

¹⁾ May not exceed or fall below U_v tolerances.

²⁾ Without signal strength light bar and load.

³⁾ Pin 4 and Pin 2: this switching output must not be connected to any other output.

⁴⁾ Signal transit time with resistive load.

⁵⁾ With light/dark ratio 1:1.

⁶⁾ A = V_S connections reverse-polarity protected.

⁷⁾ B = inputs and output reverse-polarity protected.

⁸⁾ D = outputs overcurrent and short-circuit protected.

Classifications

ECLASS 5.0	27270902
ECLASS 5.1.4	27270902

ECLASS 6.0	27270902
ECLASS 6.2	27270902
ECLASS 7.0	27270902
ECLASS 8.0	27270902
ECLASS 8.1	27270902
ECLASS 9.0	27270902
ECLASS 10.0	27270902
ECLASS 11.0	27270902
ECLASS 12.0	27270902
ETIM 5.0	EC002717
ETIM 6.0	EC002717
ETIM 7.0	EC002717
ETIM 8.0	EC002717
UNSPSC 16.0901	39121528

Connection/Pin assignment

Connection type	Cable with M12 male connector, 4-pin, 150 mm
Connection type Detail	
Conductor cross section	0.2 mm ²
Cable material	PVC
Pin assignment	
BN 1	+ (L+)
WH 2	Q ₂
BU 3	- (M)
BK 4	Q ₁

Dimensional drawing (Dimensions in mm (inch))

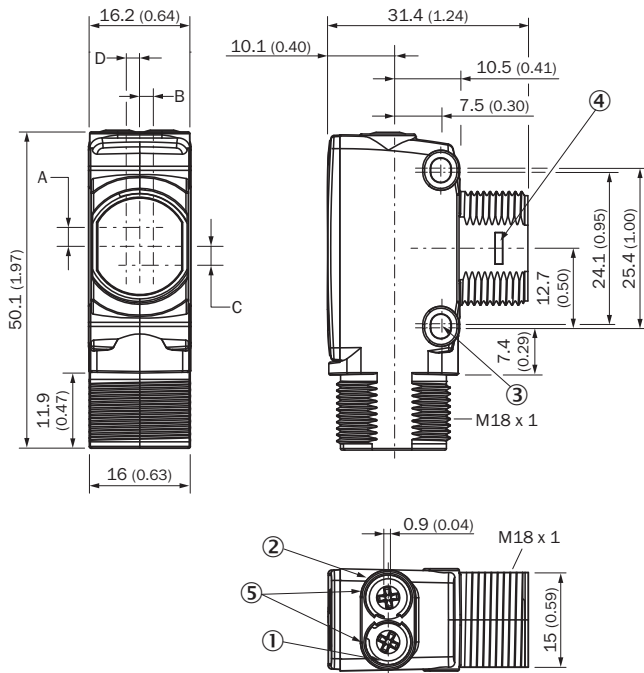

- ① LED indicator yellow: Status of received light beam
- ② LED indicator green: power on
- ③ M3 mounting hole
- ④ Snap Connection for flush ring (sold separately)
- ⑤ Potentiometer (if selected) or LED Indicators

Dimensions in mm (inch)	Receiver		Sender	
	A	B	C	D
HTB18 / HTF18	- 1.1 (0.04)	1.1 (0.04)	4.7 (0.19)	0.6 (0.02)
HTE18 / HL18 / HSE18	2.5 (0.1)	0.0 (0.0)	4.0 (0.16)	0.0 (0.0)
HTB18L / HTF18L / HL18L / HSE18L	2.5 (0.1)	0.0 (0.0)	3.5 (0.14)	0.0 (0.0)

Connection type

Connection type. see table: Connection/PIN assignment

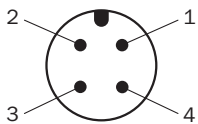

M12 male connector, 4-pin, A-coding

Adjustments possible

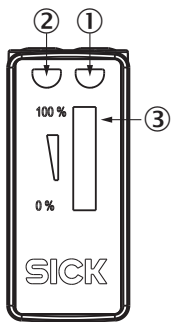

- ① LED indicator yellow: Status of received light beam
- ② LED indicator green: power on
- ③ Signal strength light bar

Characteristic curve

Operating reserve

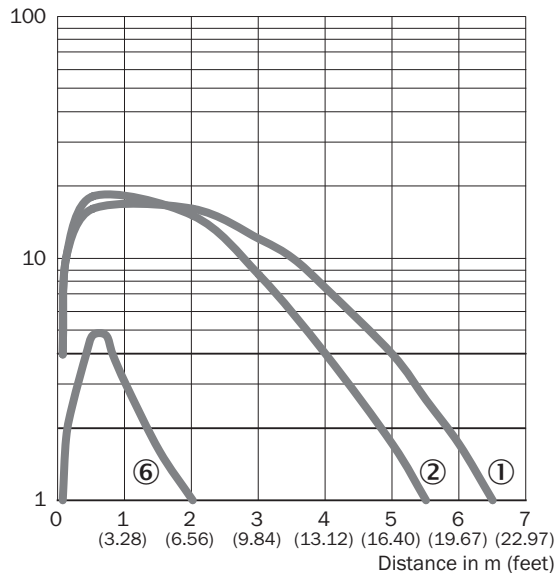

- ① Reflector PL80A
- ② Reflector PL40A
- ③ Reflective tape IREF6000 (REF-IRF-56)

Light spot size

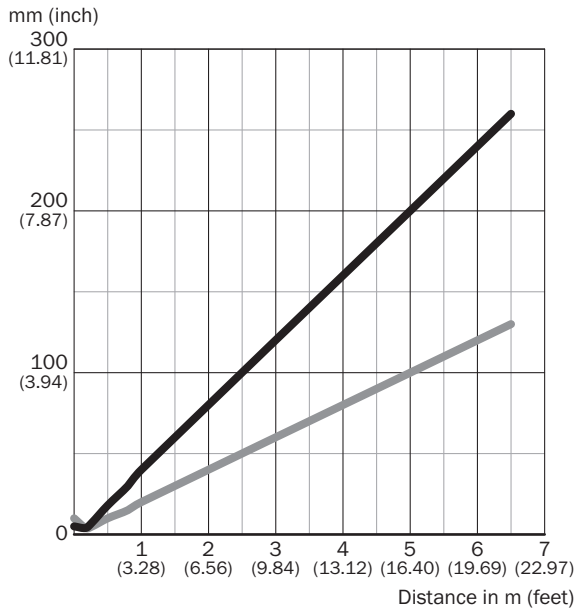

Dimensions in mm (inch)

Sensing range	Horizontal	Vertical
0.5 m (1.64 feet)	18 (0.71)	10 (0.39)
1 m (3.28 feet)	40 (1.57)	20 (0.79)
5 m (16.40 feet)	200 (7.87)	100 (3.94)
6.5 m (21.33 feet)	260 (10.24)	130 (5.12)

Horizontal
 Vertical

Sensing range diagram

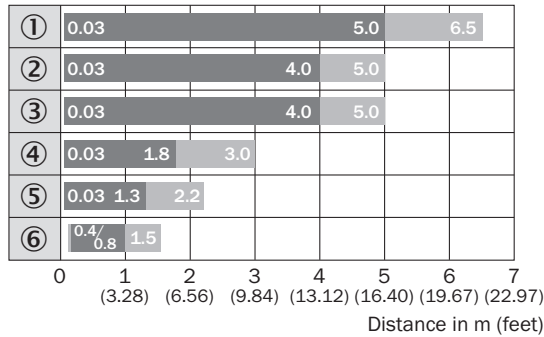

Sensing range
 Sensing range max.



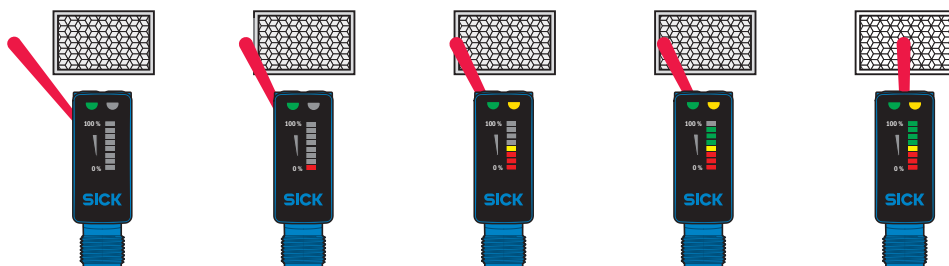

- ① Reflector PL80A
- ② Reflector PL40A
- ③ Reflector P250
- ④ Reflector PL30A, PL31A
- ⑤ Reflector PL20A
- ⑥ Reflective tape IREF6000 (REF-IRF-56)

Functions



Recommended accessories

Other models and accessories → www.sick.com/H18_Sure_Sense

	Brief description	Type	Part no.
Mounting brackets and plates			
	Universal mounting bracket for reflectors, steel, zinc coated	BEF-WN-REFX	2064574
Plug connectors and cables			
	<ul style="list-style-type: none"> • Connection type head A: Female connector, M12, 4-pin, straight, A-coded • Connection type head B: Flying leads • Signal type: Sensor/actuator cable • Cable: 5 m, 4-wire, PVC • Description: Sensor/actuator cable, unshielded • Application: Zones with chemicals 	YF2A14-050VB3XLEAX	2096235
	<ul style="list-style-type: none"> • Connection type head A: Male connector, M12, 4-pin, straight • Description: Unshielded • Connection systems: Screw-type terminals • Permitted cross-section: ≤ 0.75 mm² 	STE-1204-G	6009932
Reflectors			
	Rectangular, screw connection, 51 mm x 61 mm, PMMA/ABS, Screw-on, 2 hole mounting	P250	5304812

SICK AT A GLANCE

SICK is one of the leading manufacturers of intelligent sensors and sensor solutions for industrial applications. A unique range of products and services creates the perfect basis for controlling processes securely and efficiently, protecting individuals from accidents and preventing damage to the environment.

We have extensive experience in a wide range of industries and understand their processes and requirements. With intelligent sensors, we can deliver exactly what our customers need. In application centers in Europe, Asia and North America, system solutions are tested and optimized in accordance with customer specifications. All this makes us a reliable supplier and development partner.

Comprehensive services complete our offering: SICK LifeTime Services provide support throughout the machine life cycle and ensure safety and productivity.

For us, that is “Sensor Intelligence.”

WORLDWIDE PRESENCE:

Contacts and other locations –www.sick.com