



HL18G-P4A3BL

H18 Sure Sense

HYBRID PHOTOELECTRIC SENSORS

SICK
Sensor Intelligence.



Illustration may differ



Ordering information

| Type | Part no. |
|--------------|----------|
| HL18G-P4A3BL | 1071037 |

Other models and accessories → www.sick.com/H18_Sure_Sense

Detailed technical data

Features

| | |
|--|---------------------------------------|
| Functional principle | Photoelectric retro-reflective sensor |
| Functional principle detail | Dual lens |
| Dimensions (W x H x D) | 16.2 mm x 48.5 mm x 31.8 mm |
| Housing design (light emission) | Hybrid |
| Thread diameter (housing) | M18 |
| Mounting system type | M18, head/side (24.1 ... 25.4 mm) |
| Housing color | Blue |
| Sensing range max. | 0.1 m ... 3 m ¹⁾ |
| Sensing range | 0.1 m ... 2.5 m ¹⁾ |
| Type of light | Visible red light |
| Light source | PinPoint LED ²⁾ |
| Light spot size (distance) | 60 mm x 120 mm (3 m) |
| Wave length | 631 nm |
| Adjustment | |
| | Potentiometer, right Teach-in |
| | Potentiometer, left None |
| AutoAdapt | ✓ |
| Special applications | Detecting transparent objects |
| Special features | Signal strength light bar |

¹⁾ Reflector PL80A.

²⁾ Average service life: 100,000 h at T_U = +25 °C.

AutoAdapt

1) Reflector PL80A.

2) Average service life: 100,000 h at $T_U = +25 \text{ °C}$.

Mechanics/electronics

| | |
|--|--|
| Supply voltage | 10 V DC ... 30 V DC |
| Ripple | $< 5 V_{pp}^{1)}$ |
| Current consumption | $\leq 20 \text{ mA}^{2)}$ |
| Switching output | PNP |
| Output function | Complementary |
| Switching mode | Light/dark switching |
| Switching output detail | |
| Switching output Q1 | PNP, Light switching |
| Switching output Q2 | PNP, Dark switching |
| Output current I_{max} | $\leq 100 \text{ mA}$ |
| Response time | $\leq 0.5 \text{ ms}^{3)}$ |
| Switching frequency | $1,000 \text{ Hz}^{4)}$ |
| Connection type | Male connector M12, 4-pin |
| Circuit protection | A ⁵⁾ B ⁶⁾ D ⁷⁾ |
| Protection class | III |
| Weight | 18 g |
| Polarisation filter | ✓ |
| Housing material | Plastic, VISTAL® |
| Optics material | Plastic, PMMA |
| Enclosure rating | IP67 IP69K |
| Items supplied | Fastening nut (1x), M18, plastic, black, flat |
| Electromagnetic compatibility (EMC) | EN 60947-5-2 (The sensor complies with the Radio Safety Requirements (EMC) for the industrial sector (Radio Safety Class A). It may cause radio interference if used in a residential area.) |
| Ambient operating temperature | $-40 \text{ °C} \dots +70 \text{ °C}$ |
| Ambient temperature, storage | $-40 \text{ °C} \dots +75 \text{ °C}$ |
| UL File No. | E189383 |

1) May not exceed or fall below U_V tolerances.

2) Without signal strength light bar and load.

3) Signal transit time with resistive load.

4) With light/dark ratio 1:1.

5) A = V_S connections reverse-polarity protected.

6) B = inputs and output reverse-polarity protected.

7) D = outputs overcurrent and short-circuit protected.

Safety-related parameters

| | |
|-------------------------|-------------|
| MTTF_D | 730.1 years |
| DC_{avg} | 0 % |

Classifications

| | |
|-----------------------|----------|
| ECLASS 5.0 | 27270902 |
| ECLASS 5.1.4 | 27270902 |
| ECLASS 6.0 | 27270902 |
| ECLASS 6.2 | 27270902 |
| ECLASS 7.0 | 27270902 |
| ECLASS 8.0 | 27270902 |
| ECLASS 8.1 | 27270902 |
| ECLASS 9.0 | 27270902 |
| ECLASS 10.0 | 27270902 |
| ECLASS 11.0 | 27270902 |
| ECLASS 12.0 | 27270902 |
| ETIM 5.0 | EC002717 |
| ETIM 6.0 | EC002717 |
| ETIM 7.0 | EC002717 |
| ETIM 8.0 | EC002717 |
| UNSPSC 16.0901 | 39121528 |

Connection/Pin assignment

| | |
|------------------------|---------------------------|
| Connection type | Male connector M12, 4-pin |
| Pin assignment | |
| BN 1 | + (L+) |
| WH 2 | Q ₂ |
| BU 3 | - (M) |
| BK 4 | Q ₁ |

Dimensional drawing (Dimensions in mm (inch))

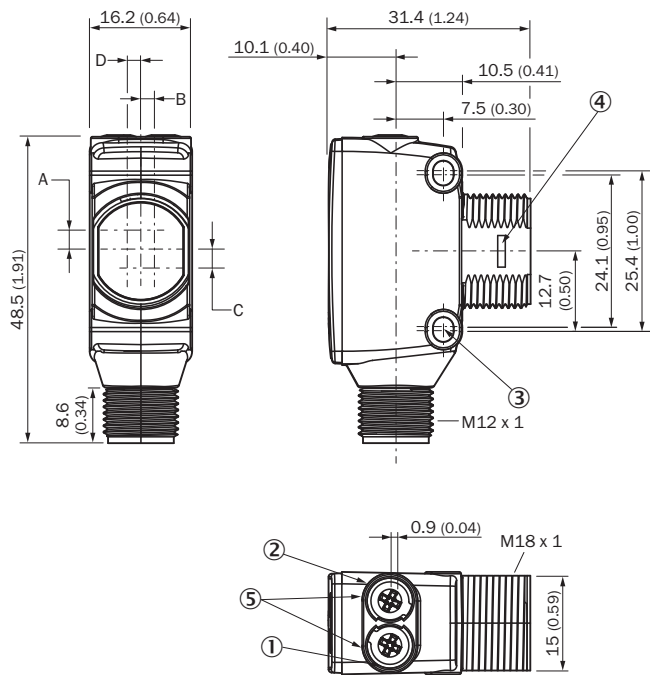

- ① LED indicator yellow: Status of received light beam
- ② LED indicator green: power on
- ③ M3 mounting hole
- ④ Snap Connection for flush ring (sold seperatly)
- ⑤ Potentiometer (if selected) or LED Indicators

| Dimensions in mm (inch) | Receiver | | Sender | |
|---|--------------|------------|------------|------------|
| | A | B | C | D |
| HTB18 / HTF18 | - 1.1 (0.04) | 1.1 (0.04) | 4.7 (0.19) | 0.6 (0.02) |
| HTE18 / HL18 / HSE18 | 2.5 (0.1) | 0.0 (0.0) | 4.0 (0.16) | 0.0 (0.0) |
| HTB18L / HTF18L / HL18L / HSE18L | 2.5 (0.1) | 0.0 (0.0) | 3.5 (0.14) | 0.0 (0.0) |

Connection type

Connection type. see table: Connection/PIN assignment

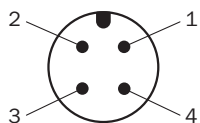

M12 male connector, 4-pin, A-coding

Adjustments possible



- ① LED indicator yellow: Status of received light beam
- ② LED indicator green: power on
- ③ Signal strength light bar

Characteristic curve

Operating reserve

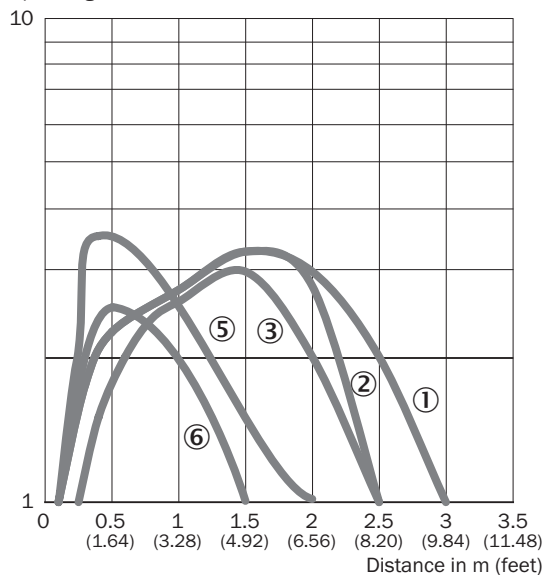

- ① Reflector PL80A
- ② Reflector PL40A
- ③ Reflector P250F
- ⑤ Reflective tape REF-AC1000
- ⑥ Reflector PL41F

Light spot size

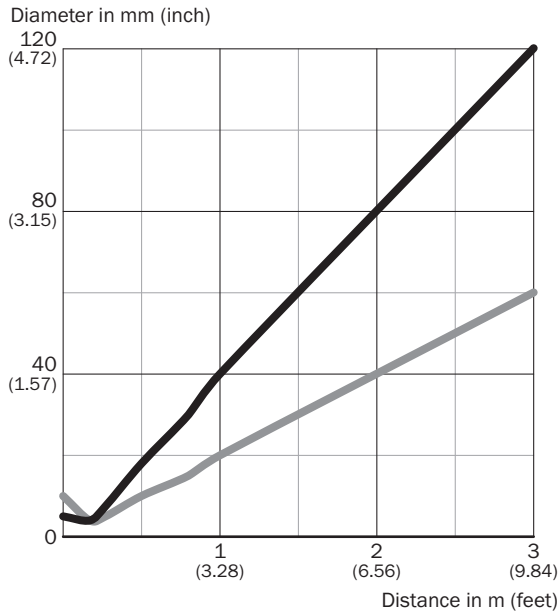

Dimensions in mm (inch)

| Sensing range | Vertical | Horizontal |
|------------------------------------|---------------|--------------|
| 0.5 m (1.64 feet) | 18 (0.71) | 10 (0.39) |
| 0.8 m (2.62 feet) | 30 (1.18) | 15 (0.59) |
| 1 m (3.28 feet) | 40 (1.57) | 20 (0.79) |
| 3 m (9.84 feet) | 120 (4.72) | 60 (2.36) |

— Vertical
— Horizontal

Sensing range diagram

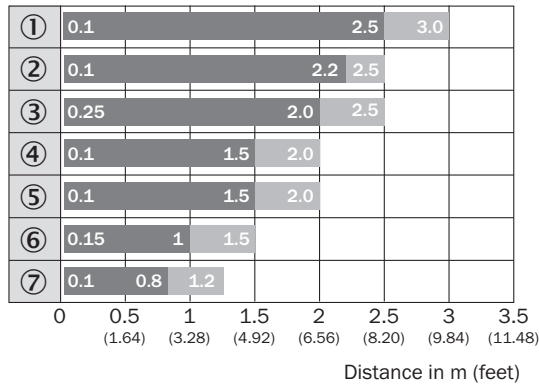

■ Sensing range ■ Sensing range max.



- ① Reflector PL80A
- ② Reflector PL40A
- ③ Reflector P250F
- ④ Reflector PL30A, PL31A
- ⑤ Reflective tape REF-AC1000
- ⑥ Reflector PL41F
- ⑦ Reflector PL20A

Functions



Recommended accessories

Other models and accessories → www.sick.com/H18_Sure_Sense

| | Brief description | Type | Part no. |
|---|---|--------------------|----------|
| Plug connectors and cables | | | |
|  | <ul style="list-style-type: none"> • Connection type head A: Female connector, M12, 4-pin, straight, A-coded • Connection type head B: Flying leads • Signal type: Sensor/actuator cable • Cable: 5 m, 4-wire, PVC • Description: Sensor/actuator cable, unshielded • Application: Zones with chemicals | YF2A14-050VB3XLEAX | 2096235 |
|  | <ul style="list-style-type: none"> • Connection type head A: Male connector, M12, 4-pin, straight • Description: Unshielded • Connection systems: Screw-type terminals • Permitted cross-section: ≤ 0.75 mm² | STE-1204-G | 6009932 |
| Reflectors | | | |
|  | Reflector with microprismatic reflex tape REF-AC1000, suitable for laser sensors, see alignment note, 29 mm x 45 mm, PMMA/ABS, Screw-on, 2 hole mounting | P41F | 5315128 |

SICK AT A GLANCE

SICK is one of the leading manufacturers of intelligent sensors and sensor solutions for industrial applications. A unique range of products and services creates the perfect basis for controlling processes securely and efficiently, protecting individuals from accidents and preventing damage to the environment.

We have extensive experience in a wide range of industries and understand their processes and requirements. With intelligent sensors, we can deliver exactly what our customers need. In application centers in Europe, Asia and North America, system solutions are tested and optimized in accordance with customer specifications. All this makes us a reliable supplier and development partner.

Comprehensive services complete our offering: SICK LifeTime Services provide support throughout the machine life cycle and ensure safety and productivity.

For us, that is “Sensor Intelligence.”

WORLDWIDE PRESENCE:

Contacts and other locations –www.sick.com