



HTB18B-P3B2BBS21

H18 Sure Sense

HYBRID PHOTOELECTRIC SENSORS

SICK
Sensor Intelligence.



Illustration may differ



Ordering information

| Type | Part no. |
|------------------|----------|
| HTB18B-P3B2BBS21 | 1100649 |

Other models and accessories → www.sick.com/H18_Sure_Sense

Detailed technical data

Features

| | |
|--|---|
| Specialty | Co-label w/ customer logo (Customer PN 1277159, douglas-machine.com), Z18 M18 nut 4040270 instead of the standard H18 M18 nut |
| Functional principle | Photoelectric proximity sensor |
| Functional principle detail | Background suppression |
| Dimensions (W x H x D) | 16.2 mm x 50.1 mm x 31.4 mm |
| Housing design (light emission) | Hybrid |
| Thread diameter (housing) | M18 |
| Mounting system type | M18, head/M18, base/side (24.1 ... 25.4 mm) |
| Housing color | Blue |
| Sensing range max. | 5 mm ... 300 mm ¹⁾ |
| Sensing range | 5 mm ... 150 mm ²⁾ |
| Type of light | Visible red light |
| Light source | PinPoint LED ³⁾ |
| Light spot size (distance) | 7 mm (300 mm) |
| Wave length | 631 nm |
| Adjustment | |
| | Potentiometer, right Sensing range |
| | Potentiometer, left None |

¹⁾ Object with 90% remission (based on standard white, DIN 5033).

²⁾ Object with 6 % reflectance (referred to standard black, DIN 5033).

³⁾ Average service life: 100,000 h at T_U = +25 °C.

| | |
|-------------------------|---------------------------|
| Special features | Signal strength light bar |
|-------------------------|---------------------------|

¹⁾ Object with 90% remission (based on standard white, DIN 5033).

²⁾ Object with 6 % reflectance (referred to standard black, DIN 5033).

³⁾ Average service life: 100,000 h at $T_U = +25\text{ °C}$.

Mechanics/electronics

| | |
|--|--|
| Supply voltage | 10 V DC ... 30 V DC |
| Ripple | $< 5\text{ V}_{pp}$ ¹⁾ |
| Current consumption | $\leq 20\text{ mA}$ ²⁾ |
| Switching output | PNP |
| Output function | Complementary |
| Switching mode | Light/dark switching |
| Switching output detail | |
| Switching output Q1 | PNP, Light switching |
| Switching output Q2 | PNP, Dark switching |
| Output current I_{max} | $\leq 100\text{ mA}$ |
| Response time | $\leq 0.5\text{ ms}$ ³⁾ |
| Switching frequency | 1,000 Hz ⁴⁾ |
| Connection type | Cable with M8 male connector, 4-pin, 150 mm |
| Cable material | PVC |
| Conductor cross section | 0.2 mm ² |
| Circuit protection | A ⁵⁾ B ⁶⁾ D ⁷⁾ |
| Protection class | III |
| Weight | 18 g |
| Housing material | Plastic, VISTAL® |
| Optics material | Plastic, PMMA |
| Enclosure rating | IP67 IP69K |
| Items supplied | Fastening nut (1x), M18, plastic, black, flat |
| Electromagnetic compatibility (EMC) | EN 60947-5-2 (The sensor complies with the Radio Safety Requirements (EMC) for the industrial sector (Radio Safety Class A). It may cause radio interference if used in a residential area.) |
| Ambient operating temperature | -40 °C ... +65 °C |
| Ambient temperature, storage | -40 °C ... +75 °C |
| UL File No. | E189383 |

¹⁾ May not exceed or fall below U_v tolerances.

²⁾ Without signal strength light bar and load.

³⁾ Signal transit time with resistive load.

⁴⁾ With light/dark ratio 1:1.

⁵⁾ A = V_S connections reverse-polarity protected.

⁶⁾ B = inputs and output reverse-polarity protected.

⁷⁾ D = outputs overcurrent and short-circuit protected.

Classifications

| | |
|-----------------------|----------|
| ECLASS 5.0 | 27270904 |
| ECLASS 5.1.4 | 27270904 |
| ECLASS 6.0 | 27270904 |
| ECLASS 6.2 | 27270904 |
| ECLASS 7.0 | 27270904 |
| ECLASS 8.0 | 27270904 |
| ECLASS 8.1 | 27270904 |
| ECLASS 9.0 | 27270904 |
| ECLASS 10.0 | 27270904 |
| ECLASS 11.0 | 27270904 |
| ECLASS 12.0 | 27270904 |
| ETIM 5.0 | EC002719 |
| ETIM 6.0 | EC002719 |
| ETIM 7.0 | EC002719 |
| ETIM 8.0 | EC002719 |
| UNSPSC 16.0901 | 39121528 |

Connection/Pin assignment

| | |
|-------------------------------|---|
| Connection type | Cable with M8 male connector, 4-pin, 150 mm |
| Connection type Detail | |
| Conductor cross section | 0.2 mm ² |
| Cable material | PVC |
| Pin assignment | |
| BN 1 | + (L+) |
| WH 2 | Q ₂ |
| BU 3 | - (M) |
| BK 4 | Q ₁ |

Dimensional drawing (Dimensions in mm (inch))

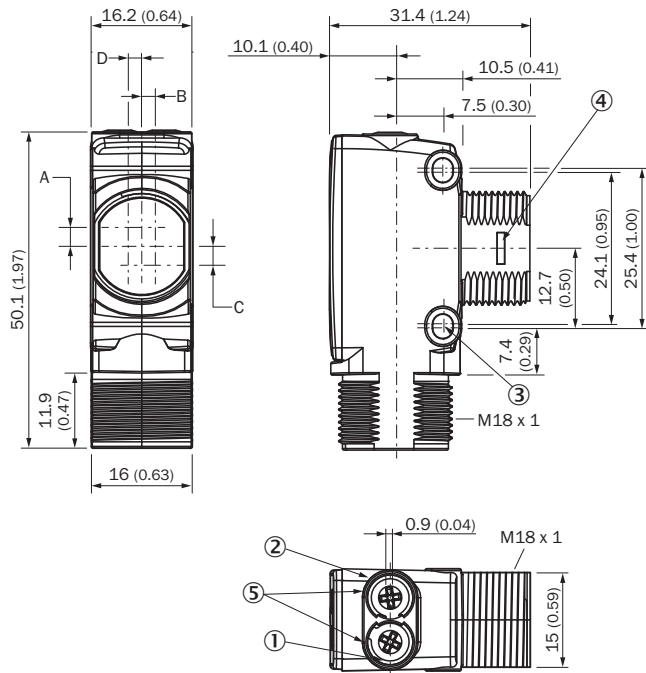

- ① LED indicator yellow: Status of received light beam
- ② LED indicator green: power on
- ③ M3 mounting hole
- ④ Snap Connection for flush ring (sold seperatly)
- ⑤ Potentiometer (if selected) or LED Indicators

| Dimensions in mm (inch) | Receiver | | Sender | |
|---|--------------|------------|------------|------------|
| | A | B | C | D |
| HTB18 / HTF18 | - 1.1 (0.04) | 1.1 (0.04) | 4.7 (0.19) | 0.6 (0.02) |
| HTE18 / HL18 / HSE18 | 2.5 (0.1) | 0.0 (0.0) | 4.0 (0.16) | 0.0 (0.0) |
| HTB18L / HTF18L / HL18L / HSE18L | 2.5 (0.1) | 0.0 (0.0) | 3.5 (0.14) | 0.0 (0.0) |

Connection type

Connection type. see table: Connection/PIN assignment

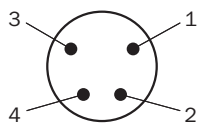

Male connector, M8, 4-pin, uncoded

Adjustments possible



- ① LED indicator yellow: Status of received light beam
- ② LED indicator green: power on
- ③ Signal strength light bar

Characteristic curve

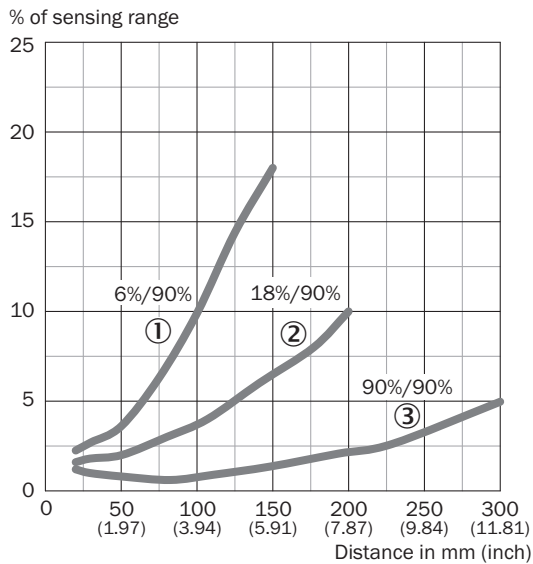

- ① Sensing range on black, 6% remission factor
- ② Sensing range on gray, 18% remission factor
- ③ Sensing range on white, 90% remission factor

Light spot size

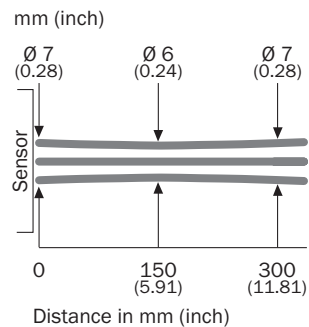

Sensing range diagram



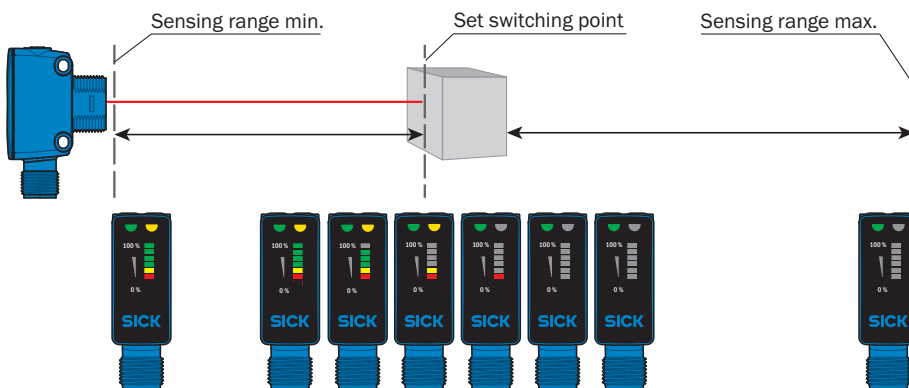

- Sensing range ■ Sensing range max.
- ① Sensing range on black, 6% remission factor
- ② Sensing range on gray, 18% remission factor
- ③ Sensing range on white, 90% remission factor

Functions



Recommended accessories

Other models and accessories → www.sick.com/H18_Sure_Sense

| | Brief description | Type | Part no. |
|---|--|--------------------|----------|
| Plug connectors and cables | | | |
|  | <ul style="list-style-type: none"> • Connection type head A: Female connector, M8, 4-pin, straight, A-coded • Connection type head B: Flying leads • Signal type: Sensor/actuator cable • Cable: 5 m, 4-wire, PVC • Description: Sensor/actuator cable, unshielded • Application: Zones with chemicals | YF8U14-050VA3XLEAX | 2095889 |
|  | <ul style="list-style-type: none"> • Connection type head A: Male connector, M8, 4-pin, straight • Description: Unshielded • Connection systems: Screw-type terminals • Permitted cross-section: 0.14 mm² ... 0.5 mm² | STE-0804-G | 6037323 |

SICK AT A GLANCE

SICK is one of the leading manufacturers of intelligent sensors and sensor solutions for industrial applications. A unique range of products and services creates the perfect basis for controlling processes securely and efficiently, protecting individuals from accidents and preventing damage to the environment.

We have extensive experience in a wide range of industries and understand their processes and requirements. With intelligent sensors, we can deliver exactly what our customers need. In application centers in Europe, Asia and North America, system solutions are tested and optimized in accordance with customer specifications. All this makes us a reliable supplier and development partner.

Comprehensive services complete our offering: SICK LifeTime Services provide support throughout the machine life cycle and ensure safety and productivity.

For us, that is “Sensor Intelligence.”

WORLDWIDE PRESENCE:

Contacts and other locations –www.sick.com