



WL9LG-3P2432

W9

SMALL PHOTOELECTRIC SENSORS

SICK
Sensor Intelligence.



Illustration may differ



Ordering information

Type	Part no.
WL9LG-3P2432	1058235

Other models and accessories → www.sick.com/W9

Detailed technical data

Features

Functional principle	Photoelectric retro-reflective sensor
Functional principle detail	Autocollimation
Dimensions (W x H x D)	12.2 mm x 52.2 mm x 23.6 mm
Housing design (light emission)	Rectangular
Mounting hole	M3
Sensing range max.	0 m ... 4.5 m ^{1) 2)}
Sensing range	0 m ... 2 m ^{1) 2)}
Type of light	Visible red light
Light source	Laser ³⁾
Light spot size (distance)	Ø 1 mm (500 mm)
Wave length	650 nm
Laser class	1 (IEC 60825-1 / CDRH 21 CFR 1040.10 & 1040.11)
Adjustment	Single teach-in button
AutoAdapt	✓
Special feature	Detecting transparent objects
Special applications	Detecting small objects, Detecting transparent objects

¹⁾ Reflective tape REF-AC1000.

²⁾ To ensure reliable operation, we recommend using REF-AC1000 reflective tape or reflective-tap reflectors such as P41F, PLV14-A, PLH25-M12, or PLH25-D12. Reflectors with large-scale triple structures must only be used if deemed suitable for the application.

³⁾ Average service life: 50,000 h at T_J = +25 °C.

Mechanics/electronics

Supply voltage U_B	10 V DC ... 30 V DC ¹⁾
Ripple	< 5 V _{pp} ²⁾
Current consumption	30 mA ³⁾
Switching output	PNP ⁴⁾
Output function	Complementary
Switching mode	Light/dark switching ⁴⁾
Output current $I_{max.}$	≤ 100 mA
Response time	≤ 0.5 ms ⁵⁾
Switching frequency	1,000 Hz ⁶⁾
Connection type	Male connector M12, 4-pin
Circuit protection	A ⁷⁾ B ⁸⁾ C ⁹⁾
Protection class	III
Weight	13 g
Polarisation filter	✓
Housing material	Plastic, VISTAL®
Optics material	Plastic, PMMA
Enclosure rating	IP66 IP67 IP69K
Special feature	Detecting transparent objects
Ambient operating temperature	-10 °C ... +50 °C
Ambient operating temperature extended	-30 °C ... +55 °C ^{10) 11)}
Ambient temperature, storage	-30 °C ... +70 °C
UL File No.	NRKH.E181493

¹⁾ Limit values when operated in short-circuit protected network: max. 8 A.

²⁾ May not exceed or fall below U_V tolerances.

³⁾ Without load.

⁴⁾ Q = light switching.

⁵⁾ Signal transit time with resistive load.

⁶⁾ With light/dark ratio 1:1.

⁷⁾ A = V_S connections reverse-polarity protected.

⁸⁾ B = inputs and output reverse-polarity protected.

⁹⁾ C = interference suppression.

¹⁰⁾ As of $T_a = 50 °C$, a max. supply voltage $V_{max.} = 24 V$ and a max. load current $I_{max.} = 50 mA$ is permitted.

¹¹⁾ Operation below $T_u -10 °C$ is possible if the sensor is already switched on at $T_u > -10 °C$, then cools down, and the supply voltage is subsequently not switched off. Switching on below $T_u -10 °C$ is not permissible.

Safety-related parameters

MTTF_D	655 years (EN ISO 13849-1) ¹⁾
DC_{avg}	0 %

¹⁾ Mode of calculation: Parts-Count-calculation.

Classifications

ECLASS 5.0	27270902
ECLASS 5.1.4	27270902
ECLASS 6.0	27270902
ECLASS 6.2	27270902
ECLASS 7.0	27270902
ECLASS 8.0	27270902
ECLASS 8.1	27270902
ECLASS 9.0	27270902
ECLASS 10.0	27270902
ECLASS 11.0	27270902
ECLASS 12.0	27270902
ETIM 5.0	EC002717
ETIM 6.0	EC002717
ETIM 7.0	EC002717
ETIM 8.0	EC002717
UNSPSC 16.0901	39121528

Adjustments

Single teach-in button

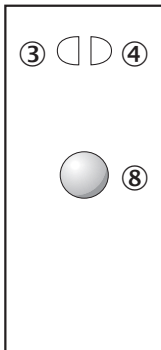

- ③ LED indicator yellow: Status of received light beam
- ④ LED indicator green: power on
- ⑧ Teach-in button

Connection diagram

Cd-083

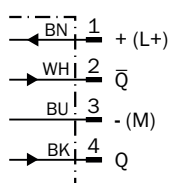

Characteristic curve

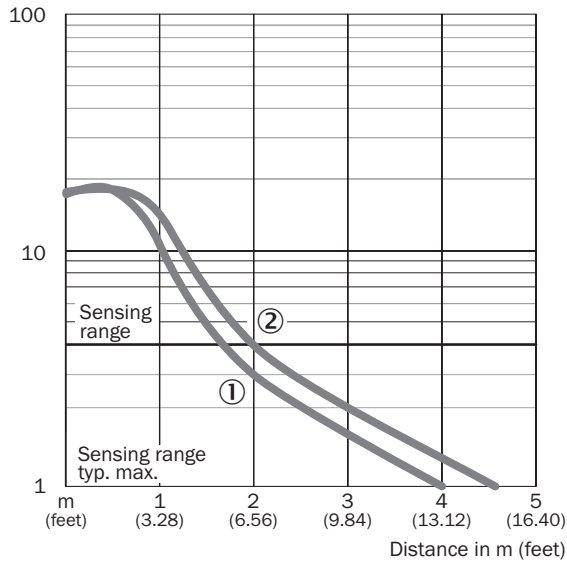

- ① Reflector PLV14-A / PLH25-M12 / PLH25-D12
- ② Reflector P41F / reflective tape REF-AC1000

Light spot size

Overview

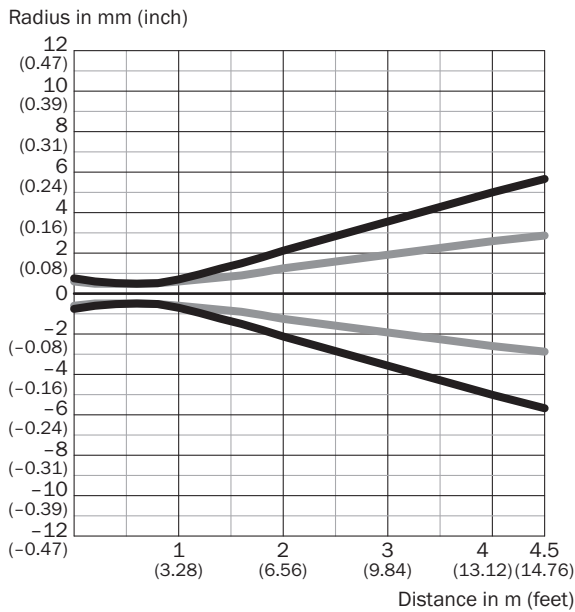

Dimensions in mm (inch)

Sensing range	Vertical	Horizontal
0.5 m (1.64 feet)	< 1.0 (0.04)	< 1.0 (0.04)
1 m (3.28 feet)	1.5 (0.06)	1.2 (0.05)
2 m (6.56 feet)	4.3 (0.17)	2.6 (0.10)
4.5 m (14.76 feet)	11.3 (0.44)	5.6 (0.22)

- Vertical
- Horizontal

Light spot size (detailed view)

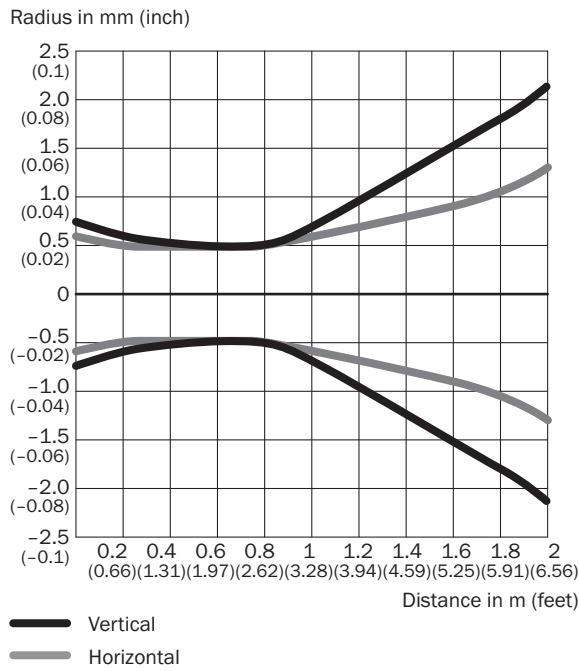

Sensing range diagram

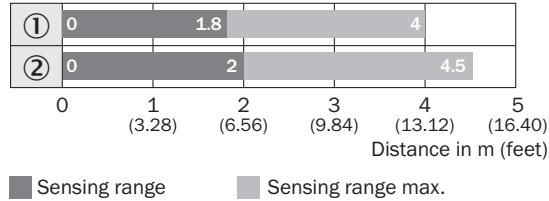

- ① Reflector PLV14-A / PLH25-M12 / PLH25-D12
- ② Reflector P41F / reflective tape REF-AC1000

Dimensional drawing (Dimensions in mm (inch))

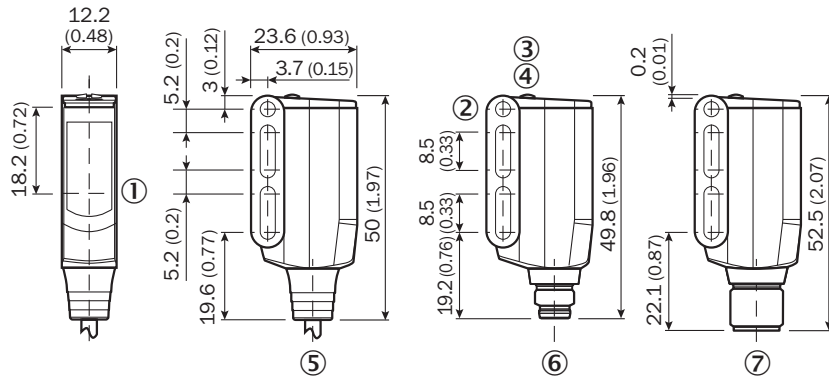

WL9L-3



- ① Sender and receiver optical axis center
- ② Mounting hole M3 (Ø 3.1 mm)
- ③ LED indicator yellow: Status of received light beam
- ④ LED indicator green: power on
- ⑤ Connecting cable or connecting cable with connector
- ⑥ Male connector M8, 4-pin
- ⑦ Male connector M12, 4-pin

Recommended accessories

Other models and accessories → www.sick.com/W9

	Brief description	Type	Part no.
Plug connectors and cables			
	Head A: female connector, M12, 4-pin, straight, A-coded Head B: Flying leads Cable: Sensor/actuator cable, PVC, unshielded, 5 m	YF2A14-050VB3XLEAX	2096235
	Head A: male connector, M12, 4-pin, straight Cable: unshielded	STE-1204-G	6009932
Reflectors			
	Suitable for laser sensors, self-adhesive, cut, see alignment note, 56.3 mm x 56.3 mm, self-adhesive	REF-AC1000-56	4063030

SICK AT A GLANCE

SICK is one of the leading manufacturers of intelligent sensors and sensor solutions for industrial applications. A unique range of products and services creates the perfect basis for controlling processes securely and efficiently, protecting individuals from accidents and preventing damage to the environment.

We have extensive experience in a wide range of industries and understand their processes and requirements. With intelligent sensors, we can deliver exactly what our customers need. In application centers in Europe, Asia and North America, system solutions are tested and optimized in accordance with customer specifications. All this makes us a reliable supplier and development partner.

Comprehensive services complete our offering: SICK LifeTime Services provide support throughout the machine life cycle and ensure safety and productivity.

For us, that is “Sensor Intelligence.”

WORLDWIDE PRESENCE:

Contacts and other locations –www.sick.com