



WTB2S-2P3245

W2

MINIATURE PHOTOELECTRIC SENSORS

SICK
Sensor Intelligence.



Ordering information

Type	Part no.
WTB2S-2P3245	1064615

Other models and accessories → www.sick.com/W2

Illustration may differ



Detailed technical data

Features

Functional principle	Photoelectric proximity sensor
Functional principle detail	Background suppression
Dimensions (W x H x D)	7.7 mm x 21.8 mm x 13.5 mm
Housing design (light emission)	Rectangular
Sensing range max.	4 mm ... 110 mm ¹⁾
Sensing range	10 mm ... 90 mm ¹⁾
Type of light	Visible red light
Light source	PinPoint LED ²⁾
Light spot size (distance)	Ø 4.4 mm (60 mm)
Wave length	640 nm
Adjustment	Cable
Special applications	Detecting small objects

¹⁾ Object with 90% remission (based on standard white, DIN 5033).

²⁾ Average service life: 100,000 h at T_J = +25 °C.

Mechanics/electronics

Supply voltage U_B	10 V DC ... 30 V DC ¹⁾
Ripple	< 5 V _{pp} ²⁾
Current consumption	20 mA ³⁾
Switching output	PNP
Switching mode	Light switching
Output current I_{max}	≤ 50 mA
Response time	< 0.5 ms ⁴⁾
Switching frequency	1,000 Hz ⁵⁾
Connection type	Cable with M8 male connector, 4-pin, 200 mm ⁶⁾
Cable material	PVC
Conductor cross section	0.09 mm ²
Cable diameter	Ø 3 mm
Circuit protection	A ⁷⁾ B ⁸⁾ D ⁹⁾
Housing material	Plastic, ABS/PC
Optics material	Plastic, PMMA
Enclosure rating	IP67
Ambient operating temperature	-25 °C ... +50 °C
Ambient temperature, storage	-40 °C ... +75 °C
UL File No.	NRKH.E181493

¹⁾ Limit values.

²⁾ May not exceed or fall below U_v tolerances.

³⁾ Without load.

⁴⁾ Signal transit time with resistive load.

⁵⁾ With light/dark ratio 1:1.

⁶⁾ Do not bend below 0 °C.

⁷⁾ A = V_S connections reverse-polarity protected.

⁸⁾ B = output reverse-polarity protected.

⁹⁾ D = outputs overcurrent and short-circuit protected.

Safety-related parameters

MTTF_D	1,547 years
DC_{avg}	0 %

Classifications

ECLASS 5.0	27270904
ECLASS 5.1.4	27270904
ECLASS 6.0	27270904
ECLASS 6.2	27270904
ECLASS 7.0	27270904
ECLASS 8.0	27270904
ECLASS 8.1	27270904

ECLASS 9.0	27270904
ECLASS 10.0	27270904
ECLASS 11.0	27270904
ECLASS 12.0	27270903
ETIM 5.0	EC002719
ETIM 6.0	EC002719
ETIM 7.0	EC002719
ETIM 8.0	EC002719
UNSPSC 16.0901	39121528

Connection diagram

Cd-092

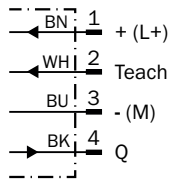

Characteristic curve

WTB2S-2, 110 mm

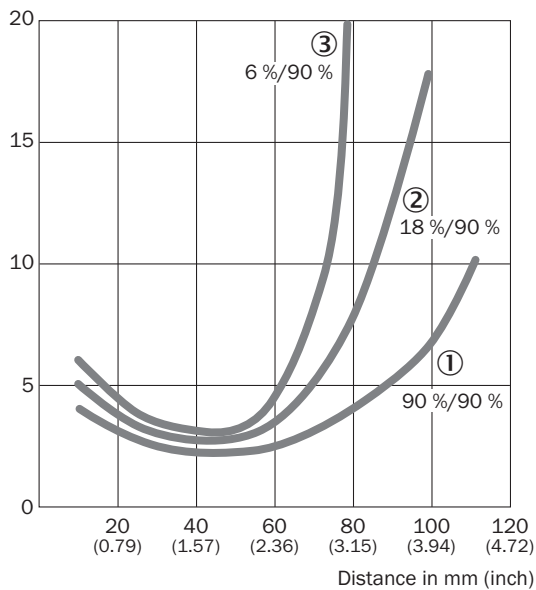

- ① Sensing range on white, 90% remission factor
- ② Sensing range on gray, 18% remission factor
- ③ Sensing range on black, 6% remission factor

Light spot size

WTB2S-2, 110 mm

Spot diameter in mm (inch)

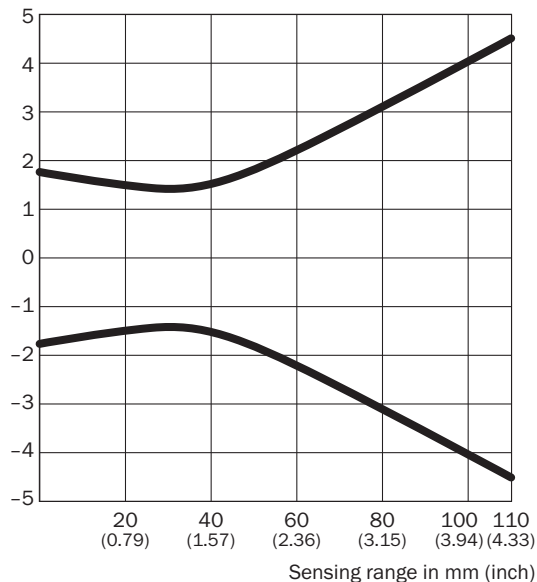

Dimensions in mm (inch)

Sensing range	Spot diameter
0 (0.00)	3.5 (0.14)
20 (0.79)	3.0 (0.12)
40 (1.57)	3.0 (0.12)
60 (2.36)	4.4 (0.17)
100 (3.94)	8.0 (0.31)
110 (4.33)	9.0 (0.35)

Sensing range diagram

WTB2S-2, 110 mm

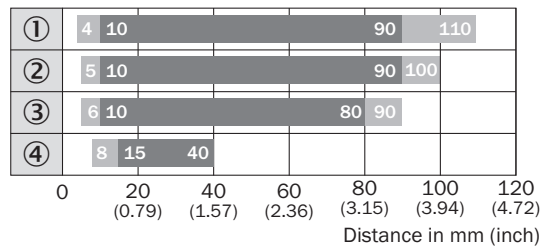

- Sensing range ■ Sensing range max.
- ① Sensing range on white, 90% remission factor
- ② Sensing range on gray, 18% remission factor
- ③ Sensing range on black, 6% remission factor
- ④ Sensing range on ultra black, 1% remission

Dimensional drawing (Dimensions in mm (inch))

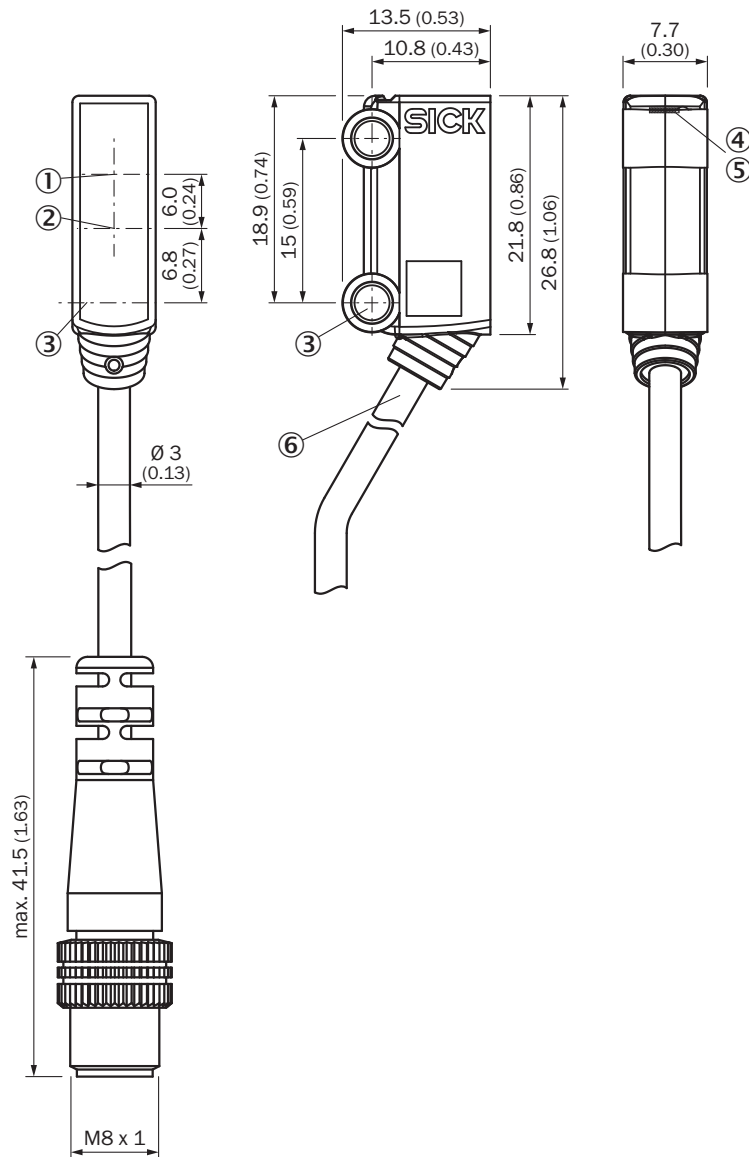

WTB2S-2, 66 mm, 90 mm, 110 mm



- ① Optical axis, receiver
- ② Optical axis, sender
- ③ Middle axis fixing hole \varnothing 3.2 mm
- ④ LED indicator green: Supply voltage active
- ⑤ LED indicator yellow: Status of received light beam
- ⑥ Connection

Recommended accessories

Other models and accessories → www.sick.com/W2

	Brief description	Type	Part no.
Plug connectors and cables			
	<ul style="list-style-type: none"> • Connection type head A: Female connector, M8, 4-pin, straight, A-coded • Connection type head B: Flying leads • Signal type: Sensor/actuator cable • Cable: 5 m, 4-wire, PVC • Description: Sensor/actuator cable, unshielded • Application: Zones with chemicals 	YF8U14-050VA3XLEAX	2095889
	<ul style="list-style-type: none"> • Connection type head A: Male connector, M8, 4-pin, straight • Description: Unshielded • Connection systems: Screw-type terminals • Permitted cross-section: 0.14 mm² ... 0.5 mm² 	STE-0804-G	6037323

SICK AT A GLANCE

SICK is one of the leading manufacturers of intelligent sensors and sensor solutions for industrial applications. A unique range of products and services creates the perfect basis for controlling processes securely and efficiently, protecting individuals from accidents and preventing damage to the environment.

We have extensive experience in a wide range of industries and understand their processes and requirements. With intelligent sensors, we can deliver exactly what our customers need. In application centers in Europe, Asia and North America, system solutions are tested and optimized in accordance with customer specifications. All this makes us a reliable supplier and development partner.

Comprehensive services complete our offering: SICK LifeTime Services provide support throughout the machine life cycle and ensure safety and productivity.

For us, that is “Sensor Intelligence.”

WORLDWIDE PRESENCE:

Contacts and other locations –www.sick.com