



# GTB10-P4401P04

G10

**SMALL PHOTOELECTRIC SENSORS**

**SICK**  
Sensor Intelligence.



### Ordering information

Type	Part no.
GTB10-P4401P04	1082388

Other models and accessories → [www.sick.com/G10](http://www.sick.com/G10)

Illustration may differ



### Detailed technical data

#### Features

<b>Functional principle</b>	Photoelectric proximity sensor
<b>Functional principle detail</b>	Background suppression
<b>Dimensions (W x H x D)</b>	20 mm x 50 mm x 39 mm
<b>Housing design (light emission)</b>	Rectangular
<b>Sensing range max.</b>	20 mm ... 950 mm <sup>1)</sup>
<b>Type of light</b>	Visible red light
<b>Light source</b>	PinPoint LED <sup>2)</sup>
<b>Light spot size (distance)</b>	Ø 4.5 mm (300 mm)
<b>Wave length</b>	625 nm
<b>Adjustment</b>	Potentiometer, 5 turns
<b>Special features</b>	High functional reliability on foil-wrapped objects Sensing range preset, 400 mm / grey (90 % Remission)

<sup>1)</sup> Object with 90% remission (based on standard white, DIN 5033).

<sup>2)</sup> Average service life: 100,000 h at T<sub>U</sub> = +25 °C.

## Mechanics/electronics

<b>Supply voltage</b>	10 V DC ... 30 V DC <sup>1)</sup>
<b>Ripple</b>	< 5 V <sub>pp</sub> <sup>2)</sup>
<b>Current consumption</b>	20 mA
<b>Switching output</b>	PNP
<b>Switching mode</b>	Light switching
<b>Output current I<sub>max.</sub></b>	≤ 100 mA
<b>Response time</b>	≤ 1 ms <sup>3)</sup>
<b>Switching frequency</b>	500 Hz <sup>4)</sup>
<b>Connection type</b>	Male connector M12, 4-pin
<b>Circuit protection</b>	A <sup>5)</sup> B <sup>6)</sup> C <sup>7)</sup> D <sup>8)</sup>
<b>Protection class</b>	III
<b>Weight</b>	35 g
<b>Special device</b>	✓
<b>Housing material</b>	Plastic, ABS/PMMA
<b>Enclosure rating</b>	IP67
<b>Items supplied</b>	Mounting system BEF-KHSQ12R02 (premounted)
<b>Electromagnetic compatibility (EMC)</b>	EN 60947-5-2
<b>Ambient operating temperature</b>	-30 °C ... +60 °C
<b>Ambient temperature, storage</b>	-40 °C ... +70 °C
<b>UL File No.</b>	NRKH.E348498 & NRKH7.E348498
<b>More standards</b>	UL325 <sup>9)</sup>

<sup>1)</sup> Limit values when operated in short-circuit protected network: max. 8 A.

<sup>2)</sup> May not exceed or fall below U<sub>v</sub> tolerances.

<sup>3)</sup> Signal transit time with resistive load.

<sup>4)</sup> With light/dark ratio 1:1.

<sup>5)</sup> A = V<sub>S</sub> connections reverse-polarity protected.

<sup>6)</sup> B = inputs and output reverse-polarity protected.

<sup>7)</sup> C = interference suppression.

<sup>8)</sup> D = outputs overcurrent and short-circuit protected.

<sup>9)</sup> Complies with the UL325 standard when used with sturdy protection hood (e.g. BEF-G10WSG, 2071960).

## Classifications

<b>eCl@ss 5.0</b>	27270904
<b>eCl@ss 5.1.4</b>	27270904
<b>eCl@ss 6.0</b>	27270904
<b>eCl@ss 6.2</b>	27270904
<b>eCl@ss 7.0</b>	27270904
<b>eCl@ss 8.0</b>	27270904
<b>eCl@ss 8.1</b>	27270904
<b>eCl@ss 9.0</b>	27270904

<b>eCl@ss 10.0</b>	27270904
<b>eCl@ss 11.0</b>	27270904
<b>eCl@ss 12.0</b>	27270903
<b>ETIM 5.0</b>	EC002719
<b>ETIM 6.0</b>	EC002719
<b>ETIM 7.0</b>	EC002719
<b>ETIM 8.0</b>	EC002719
<b>UNSPSC 16.0901</b>	39121528

### Connection diagram

Cd-066

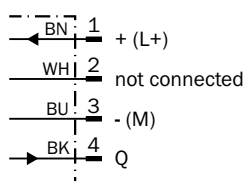

### Characteristic curve

GTB10, redlight

% of sensing range

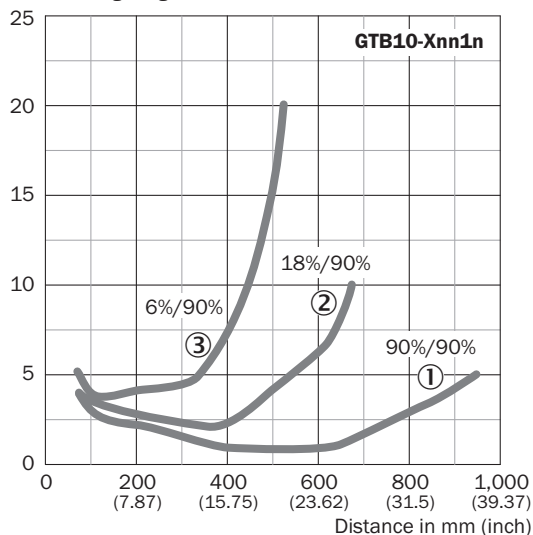

- ① Sensing range on white, 90% remission
- ② Sensing range on gray, 18% remission
- ③ Sensing range on black, 6% remission

### Light spot size

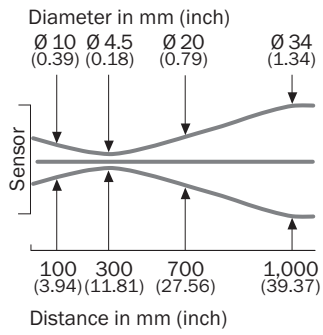

### Sensing range diagram

GTB10, redlight

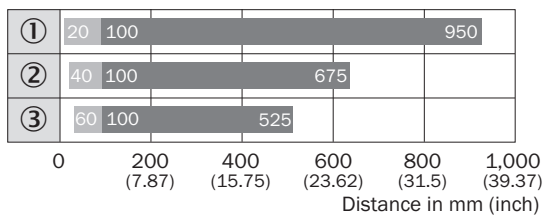

■ Sensing range      ■ Sensing range max.

- ① Sensing range on white, 90% remission
- ② Sensing range on gray, 18% remission
- ③ Sensing range on black, 6% remission

### Adjustments

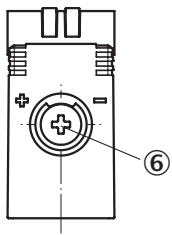

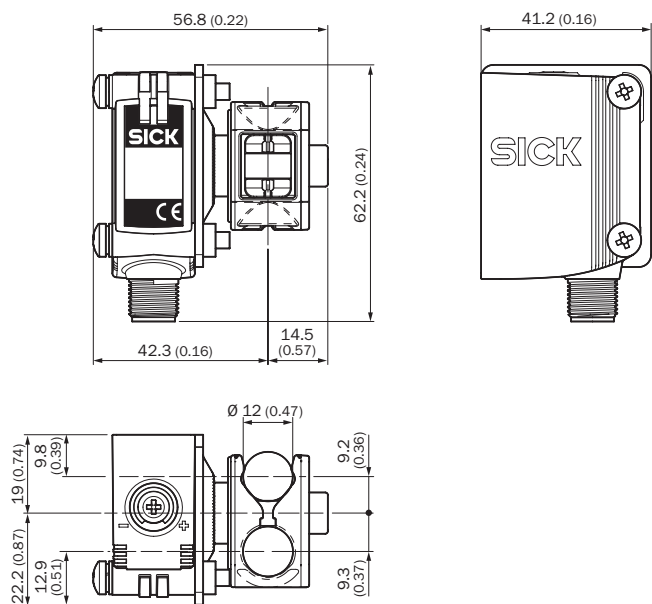

⑥ Adjustment of sensing range

Dimensional drawing (Dimensions in mm (inch))



Recommended accessories

Other models and accessories → [www.sick.com/G10](http://www.sick.com/G10)

	Brief description	Type	Part no.
<b>Universal bar clamp systems</b>			
	Q-Lock, bar clamp system for G10 and reflector P250, Die-cast zinc, steel, zinc coated	BEF-KHSQ12R01	2071260
<b>Plug connectors and cables</b>			
	Head A: female connector, M12, 4-pin, straight, A-coded Head B: Flying leads Cable: Sensor/actuator cable, PVC, unshielded, 5 m	YF2A14-050VB3XLEAX	2096235
	Head A: male connector, M12, 4-pin, straight Cable: unshielded	STE-1204-G	6009932

## SICK AT A GLANCE

SICK is one of the leading manufacturers of intelligent sensors and sensor solutions for industrial applications. A unique range of products and services creates the perfect basis for controlling processes securely and efficiently, protecting individuals from accidents and preventing damage to the environment.

We have extensive experience in a wide range of industries and understand their processes and requirements. With intelligent sensors, we can deliver exactly what our customers need. In application centers in Europe, Asia and North America, system solutions are tested and optimized in accordance with customer specifications. All this makes us a reliable supplier and development partner.

Comprehensive services complete our offering: SICK LifeTime Services provide support throughout the machine life cycle and ensure safety and productivity.

For us, that is “Sensor Intelligence.”

## WORLDWIDE PRESENCE:

Contacts and other locations –[www.sick.com](http://www.sick.com)