



BTFO8-I1BM0299

HighLine

WIRE DRAW ENCODERS

SICK
Sensor Intelligence.



Ordering information

Type	Part no.
BTF08-I1BM0299	1060968

Included in delivery: AFM60A-S1IB018x12 (1), MRA-F080-102D2 (1)

Product is supplied fully assembled. See individual components for further technical data

Other models and accessories → www.sick.com/HighLine



Detailed technical data

Performance

Measurement range	0 m ... 2 m
Encoder	Absolute encoders
Resolution (wire draw + encoder)	0.0008 mm ^{1) 2)}
Repeatability	≤ 1 mm ³⁾
Linearity	≤ ± 2 mm ³⁾
Hysteresis	≤ 2 mm ³⁾

¹⁾ The values shown have been rounded.

²⁾ Example calculation based on the BTF08 with PROFINET: 200 mm (wire draw length per revolution - see Mechanical data): 262,144 (number of steps per revolution) = 0.001 mm (resolution of wire draw + encoder combination).

³⁾ Value applies to wire draw mechanism.

Interfaces

Communication interface	EtherNet/IP™
Programmable/configurable	✓

Electrical data

Connection type	Male connector, Female connector, 1x, 2x, M12, M12, 4-pin, 4-pin, axial, axial
Supply voltage	10 V DC ... 30 V DC
Power consumption	≤ 3 W (without load)
MTTFd: mean time to dangerous failure	80 years (EN ISO 13849-1) ¹⁾

¹⁾ This product is a standard product and does not constitute a safety component as defined in the Machinery Directive. Calculation based on nominal load of components, average ambient temperature 40 °C, frequency of use 8760 h/a. All electronic failures are considered hazardous. For more information, see document no. 8015532.

Mechanical data

Weight	1.5 kg
---------------	--------

¹⁾ These values were measured at an ambient temperature of 25 °C. There may be variations at other temperatures.

²⁾ Average values, which depend on the application.

³⁾ The service life depends on the type of load. This is influenced by environmental conditions, the installation location, the measuring range in use, the traversing speed, and acceleration.

Measuring wire material	Highly flexible stranded steel 1,4401 stainless steel V4A
Measuring wire diameter	1.35 mm
Weight (measuring wire)	7.1 g/m
Housing material, wire draw mechanism	Aluminum (anodized), aluminum die cast (nickel-plated)
Spring return force	6 N ... 14 N ¹⁾
Length of wire pulled out per revolution	200 mm
Life of wire draw mechanism	Typ. 1,000,000 cycles ^{2) 3)}
Actual wire draw length	2.2 m
Wire acceleration	40 m/s ²
Operating speed	8 m/s
Mounted encoder	AFM60 EtherNet/IP, AFM60A-S1B018X12, 1055331
Mounted mechanic	MRA-F080-102D2, 6028625

¹⁾ These values were measured at an ambient temperature of 25 °C. There may be variations at other temperatures.

²⁾ Average values, which depend on the application.

³⁾ The service life depends on the type of load. This is influenced by environmental conditions, the installation location, the measuring range in use, the traversing speed, and acceleration.

Ambient data

EMC	According to EN 61000-6-2 and EN 61000-6-3 ¹⁾
Enclosure rating	IP64, mounted mechanic IP67, Encoder (IEC 60529) ²⁾
Operating temperature range	-30 °C ... +70 °C

¹⁾ EMC according to the standards quoted is achieved if shielded cables are used.

²⁾ With mating connector fitted.

Classifications

eCI@ss 5.0	27270590
eCI@ss 5.1.4	27270590
eCI@ss 6.0	27270590
eCI@ss 6.2	27270590
eCI@ss 7.0	27270590
eCI@ss 8.0	27270590
eCI@ss 8.1	27270590
eCI@ss 9.0	27270590
eCI@ss 10.0	27270613
eCI@ss 11.0	27270503
eCI@ss 12.0	27270503
ETIM 5.0	EC001486
ETIM 6.0	EC001486
ETIM 7.0	EC001486
ETIM 8.0	EC001486
UNSPSC 16.0901	41112113

Dimensional drawing (Dimensions in mm (inch))

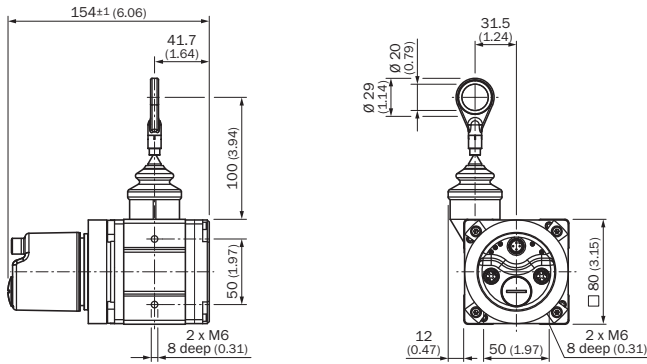

PIN assignment

Male connector

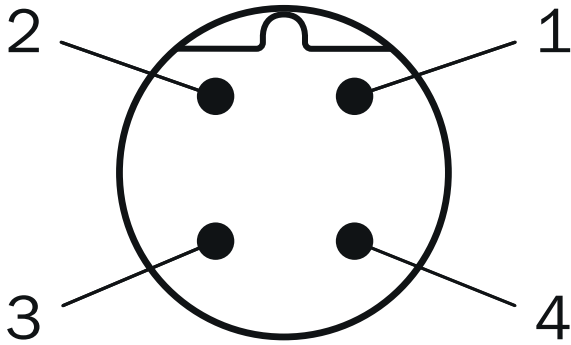

Supply voltage

PIN	Signal
1	10 V ... 30 V
2	Not assigned
3	GND
4	Not assigned

Female connector

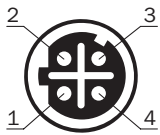

Port 1, Port 2

PIN	Signal
1	T x D+
2	R x D+
3	T x D-
4	R x D-

Connection diagram

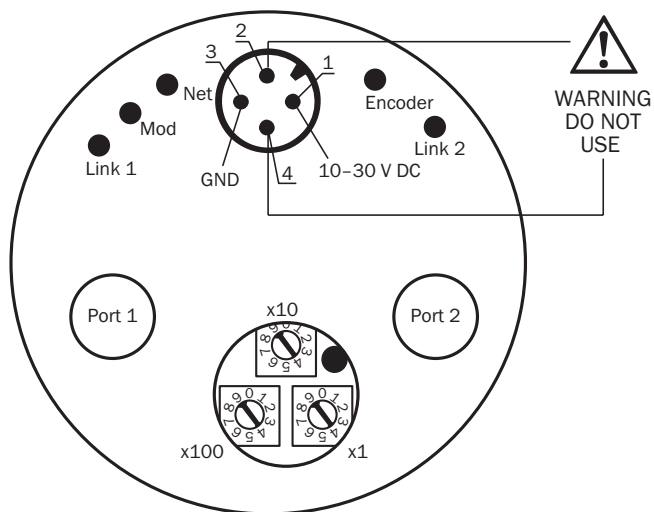











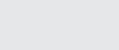

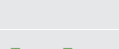

Recommended accessories

Other models and accessories → www.sick.com/HighLine

	Brief description	Type	Part no.
Wire draw mechanism			
	HighLine wire draw mechanism for servo flange with 6 mm shaft, measuring range 0 m ... 2 m	MRA-F080-102D2	6028625
Flanges			
	Flange adapter for HighLine wire draw mechanisms, adaption of face mount flange with centering hub 20 mm to 50 mm servo flange, Aluminum, including 3 countersunk screws M3 x 10	BEF-FA-020-050WDE	2073776
Other mounting accessories			
	Joint ball for later insertion in wire end ring with 20 mm diameter. The use of this joint ball enables movement in multiple levels of freedom.	Joint protection for wire rope BTF/PRF/MRA	5318683
	Compressed air attachment for MRA-F080... and MRA-F130... HighLine wire draw mechanism	MRA-F-P	6073769
	Additional brush attachment for wire draw mechanism MRA-F080 (2 m and 3 m from HighLine series)	MRA-F080-B	6045341
	Wire draw deflection pulley for wire draw mechanism MRA-F080 (2m and 3m from High-Line series)	MRA-F080-R	6028632
Plug connectors and cables			
	Head A: male connector, M12, 4-pin, straight, D-coded Head B: Flying leads Cable: Ethernet, PUR, halogen-free, shielded, 2 m	STL-1204-G02ME90	6045284

	Brief description	Type	Part no.
	Head A: male connector, M12, 4-pin, straight, D-coded Head B: Flying leads Cable: Ethernet, PUR, halogen-free, shielded, 5 m	STL-1204-G05ME90	6045285
	Head A: male connector, M12, 4-pin, straight, D-coded Head B: Flying leads Cable: Ethernet, PUR, halogen-free, shielded, 10 m	STL-1204-G10ME90	6045286
	Head A: male connector, M12, 4-pin, angled, D-coded Head B: Flying leads Cable: Ethernet, PUR, halogen-free, shielded, 2 m	STL-1204-W02ME90	6047912
	Head A: male connector, M12, 4-pin, angled, D-coded Head B: Flying leads Cable: Ethernet, PUR, halogen-free, shielded, 10 m	STL-1204-W10ME90	6047914
	Head A: male connector, M12, 4-pin, angled, D-coded Head B: Flying leads Cable: Ethernet, PUR, halogen-free, shielded, 25 m	STL-1204-W25ME90	6047915
	Head A: female connector, M12, 4-pin, straight, A-coded Head B: Flying leads Cable: Sensor/actuator cable, PUR, halogen-free, unshielded, 2 m	YF2A14-020UB3XLEAX	2095607
	Head A: female connector, M12, 4-pin, straight, A-coded Head B: Flying leads Cable: Sensor/actuator cable, PUR, halogen-free, unshielded, 5 m	YF2A14-050UB3XLEAX	2095608
	Head A: female connector, M12, 4-pin, straight, A-coded Head B: Flying leads Cable: Sensor/actuator cable, PUR, halogen-free, unshielded, 10 m	YF2A14-100UB3XLEAX	2095609
	Head A: female connector, M12, 4-pin, straight, A-coded Head B: Flying leads Cable: Sensor/actuator cable, PUR, halogen-free, unshielded, 25 m	YF2A14-250UB3XLEAX	2095615
	Head A: female connector, M12, 4-pin, angled, A-coded Head B: Flying leads Cable: Sensor/actuator cable, PUR, halogen-free, unshielded, 2 m	YG2A14-020UB3XLEAX	2095766
	Head A: female connector, M12, 4-pin, angled, A-coded Head B: Flying leads Cable: Sensor/actuator cable, PUR, halogen-free, unshielded, 5 m	YG2A14-050UB3XLEAX	2095767
	Head A: female connector, M12, 4-pin, angled, A-coded Head B: Flying leads Cable: Sensor/actuator cable, PUR, halogen-free, unshielded, 10 m	YG2A14-100UB3XLEAX	2095768
	Head A: female connector, M12, 4-pin, angled, A-coded Head B: Flying leads Cable: Sensor/actuator cable, PUR, halogen-free, unshielded, 25 m	YG2A14-250UB3XLEAX	2095771
	Head A: male connector, M12, 4-pin, angled, D-coded Head B: Flying leads Cable: Ethernet, PROFINET, PUR, halogen-free, shielded, 5 m	YN2D24-050PN1XLEAX	2106175
	Head A: male connector, M12, 4-pin, straight, D-coded Head B: male connector, M12, 4-pin, straight, D-coded Cable: Ethernet, PUR, halogen-free, shielded, 5 m	SSL-1204-G05ME90	6045277
	Head A: male connector, M12, 4-pin, straight, D-coded Head B: male connector, M12, 4-pin, straight, D-coded Cable: Ethernet, PUR, halogen-free, shielded, 10 m	SSL-1204-G10ME90	6045279
	Head A: male connector, M12, 4-pin, straight, D-coded Head B: male connector, M12, 4-pin, straight, D-coded Cable: Ethernet, PROFINET, PUR, halogen-free, shielded, 2 m	YM2D24-020PN1M2D24	2106159
	Head A: male connector, M12, 4-pin, straight, D-coded Head B: male connector, RJ45, 4-pin, straight Cable: Ethernet, PROFINET, PUR, halogen-free, shielded, 2 m	YM2D24-020PN1MRJA4	2106182

	Brief description	Type	Part no.
	Head A: male connector, M12, 4-pin, straight, D-coded Head B: male connector, RJ45, 8-pin, straight Cable: Ethernet, twisted pair, PUR, halogen-free, shielded, 5 m	YM2D24-050EA1MRJA4	6034415
	Head A: male connector, M12, 4-pin, straight, D-coded Head B: male connector, RJ45, 4-pin, straight Cable: Ethernet, PROFINET, PUR, halogen-free, shielded, 5 m	YM2D24-050PN1MRJA4	2106184
	Head A: male connector, M12, 4-pin, straight, D-coded Head B: male connector, RJ45, 4-pin, straight Cable: Ethernet, PROFINET, PUR, halogen-free, shielded, 10 m	YM2D24-100PN1MRJA4	2106185
	Head A: male connector, M12, 4-pin, angled, D-coded Head B: male connector, RJ45, 4-pin, straight Cable: Ethernet, PROFINET, PUR, halogen-free, shielded, 2 m	YN2D24-020PN1MRJA4	2106162
	Head A: male connector, M12, 4-pin, angled, D-coded Head B: male connector, M12, 4-pin, angled, D-coded Cable: Ethernet, PROFINET, PUR, halogen-free, shielded, 2 m	YN2D24-020PN1N2D24	2106168
	Head A: male connector, M12, 4-pin, angled, D-coded Head B: male connector, RJ45, 4-pin, straight Cable: Ethernet, PROFINET, PUR, halogen-free, shielded, 5 m	YN2D24-050PN1MRJA4	2106163
	Head A: male connector, M12, 4-pin, angled, D-coded Head B: male connector, RJ45, 4-pin, straight Cable: Ethernet, PROFINET, PUR, halogen-free, shielded, 10 m	YN2D24-100PN1MRJA4	2106164
	Head A: female connector, M12, 4-pin, straight, D-coded Cable: Ethernet, shielded	DOS-1204-GE	6048153
	Head A: female connector, M12, 4-pin, angled Cable: unshielded	DOS-1204-W	6007303
	Head A: female connector, M12, 4-pin, angled, D-coded Cable: Ethernet, shielded	DOS-1204-WE	6048154
	Head A: male connector, RJ45, 8-pin, straight Cable: EtherNet/IP™, shielded	STE-0J08-GE	6048150
	Head A: male connector, M12, 4-pin, straight, D-coded Cable: Ethernet, shielded	STE-1204-GE01	6048151
	Head A: male connector, M12, 4-pin, angled, D-coded Cable: Ethernet, shielded	STE-1204-WE	6048152
	Head A: female connector, M12, 4-pin, D-coded Head B: female connector, RJ45, 8-pin Cable: Ethernet, shielded Cabinet through	Feedthrough female connector Ethernet RJ45	6048180

SICK AT A GLANCE

SICK is one of the leading manufacturers of intelligent sensors and sensor solutions for industrial applications. A unique range of products and services creates the perfect basis for controlling processes securely and efficiently, protecting individuals from accidents and preventing damage to the environment.

We have extensive experience in a wide range of industries and understand their processes and requirements. With intelligent sensors, we can deliver exactly what our customers need. In application centers in Europe, Asia and North America, system solutions are tested and optimized in accordance with customer specifications. All this makes us a reliable supplier and development partner.

Comprehensive services complete our offering: SICK LifeTime Services provide support throughout the machine life cycle and ensure safety and productivity.

For us, that is “Sensor Intelligence.”

WORLDWIDE PRESENCE:

Contacts and other locations –www.sick.com