



WLA26P-24161100A00

W26

COMPACT PHOTOELECTRIC SENSORS

SICK
Sensor Intelligence.



Illustration may differ



Ordering information

Type	Part no.
WLA26P-24161100A00	1221732

Other models and accessories → www.sick.com/W26

Detailed technical data

Features

Functional principle	Photoelectric retro-reflective sensor
Functional principle detail	Autocollimation
Sensing range	
Sensing range min.	0 m
Sensing range max.	18 m
Maximum distance range from reflector to sensor (operating reserve 1)	0 m ... 18 m
Recommended distance range from reflector to sensor (operating reserve 3,75)	0 m ... 12 m
Reference reflector	Reflector PL80A
Recommended sensing range for the best performance	0 m ... 12 m
Polarisation filters	Yes
Emitted beam	
Light source	PinPoint LED
Type of light	Visible red light
Shape of light spot	Point-shaped
Light spot size (distance)	Ø 100 mm (10 m)

Maximum dispersion of the emitted beam around the standardized transmission axis (squint angle)	< +/- 1.0° (at T _a = +23 °C)
Key LED figures	
Normative reference	EN 62471:2008-09 IEC 62471:2006, modified
LED risk group marking	Free group
Wave length	635 nm
Average service life	100,000 h at T _a = +25 °C
Adjustment	
IO-Link	For configuring the sensor parameters and Smart Task functions
Indication	
LED blue	BluePilot: Alignment aid
LED green	Operating indicator Static on: power on Flashing: IO-Link mode
LED yellow	Status of received light beam Static on: object not present Static off: object present Flashing: Below the 1.5 function reserve
Special applications	Detecting objects wrapped in film

Safety-related parameters

MTTF_D	690 years
DC_{avg}	0%
T_M (mission time)	20 years (EN ISO 13849, rate of use: 60 %)

Communication interface

IO-Link	✓, V1.1
Data transmission rate	COM2 (38,4 kBaud)
Cycle time	2.3 ms
Process data length	16 Bit
Process data structure	Bit 0 = switching signal Q _{L1} Bit 1 = switching signal Q _{L2} Bit 2 ... 15 = empty
VendorID	26
DeviceID HEX	0x800180
DeviceID DEC	8388992
Compatible master port type	A
SIO mode support	Yes

Electrical data

Supply voltage U_B	10 V DC ... 30 V DC ¹⁾
Ripple	≤ 5 V _{pp}
Usage category	DC-12 (According to EN 60947-5-2) DC-13 (According to EN 60947-5-2)

- 1) Limit values.
- 2) Signal transit time with resistive load in switching mode.
- 3) With light/dark ratio 1:1.
- 4) This switching output must not be connected to another output.

Current consumption	≤ 30 mA, without load. At $U_B = 24\text{ V}$
Protection class	III
Digital output	
Number	2 (Complementary)
Type	Push-pull: PNP/NPN
Signal voltage PNP HIGH/LOW	Approx. $U_B - 2.5\text{ V} / 0\text{ V}$
Signal voltage NPN HIGH/LOW	Approx. $U_B / < 2.5\text{ V}$
Output current I_{max}	≤ 100 mA
Circuit protection outputs	Reverse polarity protected Overcurrent and short-circuit protected
Response time	≤ 500 μs ²⁾
Repeatability (response time)	150 μs
Switching frequency	1,000 Hz ³⁾
Pin/Wire assignment	
Function of pin 4/black (BK)	Digital output, dark switching, object present → output \bar{Q}_{L1} HIGH; IO-Link communication C ⁴⁾
Function of pin 4/black (BK) – detail	The pin 4 function of the sensor can be configured, Additional possible settings via IO-Link
Function of pin 2/white (WH)	Digital output, light switching, object present → output Q_{L1} LOW ⁴⁾
Function of pin 2/white (WH) – detail	The pin 2 function of the sensor can be configured, Additional possible settings via IO-Link

¹⁾ Limit values.

²⁾ Signal transit time with resistive load in switching mode.

³⁾ With light/dark ratio 1:1.

⁴⁾ This switching output must not be connected to another output.

Mechanical data

Housing	Rectangular
Dimensions (W x H x D)	24.6 mm x 82.5 mm x 53.3 mm
Connection	Male connector M12, 4-pin
Material	
Housing	Plastic, VISTAL®
Front screen	Plastic, PMMA
Male connector	Plastic, VISTAL®
Weight	Approx. 80 g
Maximum tightening torque of the fixing screws	1.3 Nm

Ambient data

Enclosure rating	IP66 (EN 60529) IP67 (EN 60529) IP69 (EN 60529) ¹⁾
Ambient operating temperature	-40 °C ... +60 °C
Ambient temperature, storage	-40 °C ... +75 °C
Shock resistance	50 g, 11 ms (25 positive and 25 negative shocks per axis, for X, Y, Z axes, 150 shocks in total (EN60068-2-27)) 50 g, 6 ms (5,000 positive and 5,000 negative shocks per axis, for X, Y, Z axes, 30,000 shocks in total (EN60068-2-27))

¹⁾ Replaces IP69K with ISO 20653: 2013-03.

Vibration resistance	10 Hz ... 2,000 Hz (Amplitude 0.5 mm / 10 g, 20 sweeps per axis, for X, Y, Z axes, 1 octave/min, (EN60068-2-6))
Air humidity	35 % ... 95 %, Relative humidity (no condensation)
Electromagnetic compatibility (EMC)	EN 60947-5-2
Resistance to cleaning agent	ECOLAB
UL File No.	NRKH.E181493 & NRKH7.E181493

¹⁾ Replaces IP69K with ISO 20653: 2013-03.

Smart Task

Smart Task name	Base logics
Logic function	Direct AND OR Window Hysteresis
Timer function	Deactivated On delay Off delay ON and OFF delay Impulse (one shot)
Inverter	Yes
Switching frequency	SIO Logic: 800 Hz ¹⁾ IOL: 650 Hz ²⁾
Response time	SIO Logic: 600 μs ¹⁾ IOL: 750 μs ²⁾
Repeatability	SIO Logic: 300 μs ¹⁾ IOL: 400 μs ²⁾
Switching signal	
Switching signal Q _{L1}	Switching output
Switching signal \bar{Q}_{L1}	Switching output

¹⁾ Use of Smart Task functions without IO-Link communication (SIO mode).

²⁾ Use of Smart Task functions with IO-Link communication function.

Diagnosis

Device status	Yes
Quality of teach	Yes
Quality of run	Yes, Contamination display

Classifications

ECLASS 5.0	27270902
ECLASS 5.1.4	27270902
ECLASS 6.0	27270902
ECLASS 6.2	27270902
ECLASS 7.0	27270902
ECLASS 8.0	27270902
ECLASS 8.1	27270902
ECLASS 9.0	27270902
ECLASS 10.0	27270902

ECLASS 11.0	27270902
ECLASS 12.0	27270902
ETIM 5.0	EC002717
ETIM 6.0	EC002717
ETIM 7.0	EC002717
ETIM 8.0	EC002717
UNSPSC 16.0901	39121528

Dimensional drawing (Dimensions in mm (inch))

Dimensional drawing, sensor

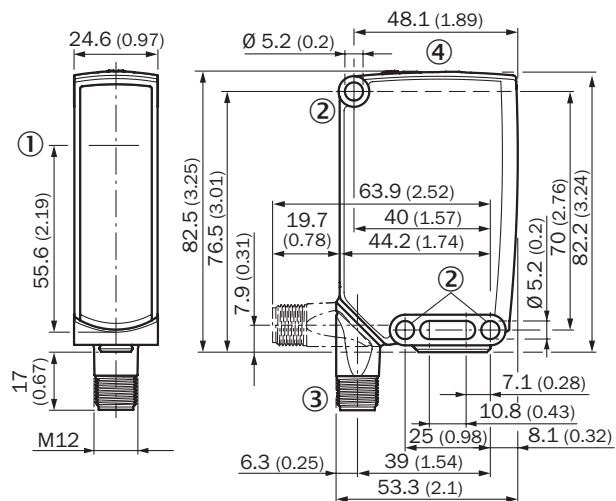

- ① Center of optical axis
- ② Mounting hole, \varnothing 5.2 mm
- ③ Connection
- ④ Display and adjustment elements

Adjustments

Display and adjustment elements

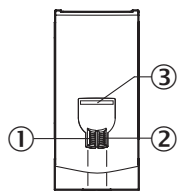

- ① LED indicator green
- ② LED indicator yellow
- ③ LED blue

Connection type

M12 male connector, 4-pin

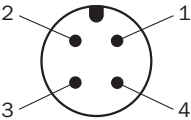

Connection diagram

Cd-390

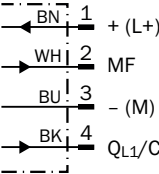

Truth table

Push-pull: PNP/NPN – dark switching \bar{Q}

	Dark switching Q (normally open (upper switch), normally closed (lower switch))	
	Object not present → Output LOW	Object present → Output HIGH
Light receive	✓	✗
Light receive indicator	☉	✗
Load resistance to L+	⚠	✗
Load resistance to M	✗	⚠

	Light switching Q (normally closed (upper switch), normally open (lower switch))	
	Object not present → Output HIGH	Object present → Output LOW
Light receive	✓	✗
Light receive indicator	☉	✗
Load resistance to L+	✗	⚠
Load resistance to M	⚠	✗

Characteristic curve

Reflective tape

Operating reserve

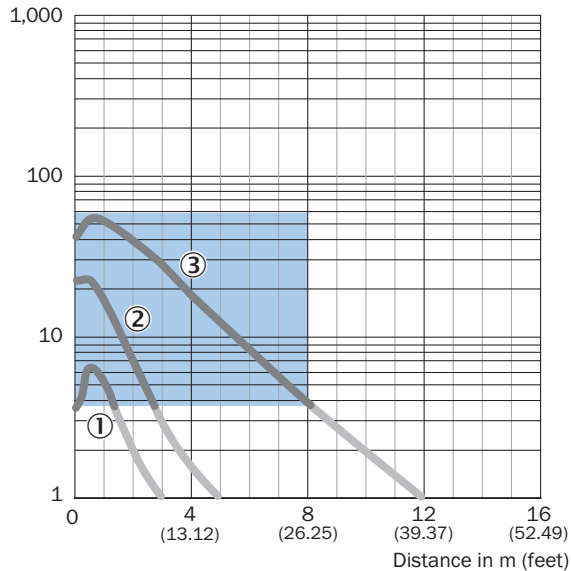

Recommended sensing range for the best performance

- ① Reflective tape REF-DG (50 x 50 mm)
- ② Reflective tape REF-IRF-56 (50 x 50 mm)
- ③ Reflective tape REF-AC1000 (50 x 50 mm)

Standard reflectors

Operating reserve

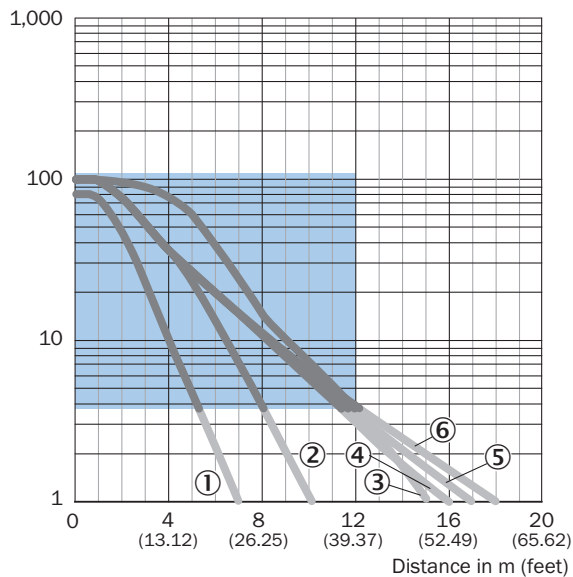

Recommended sensing range for the best performance

- ① Reflector PL20A
- ② Reflector PL22
- ③ Reflector PL250
- ④ Reflector PL30A
- ⑤ Reflector PL40A
- ⑥ Reflector PL80A, C110A

Chemical-resistant reflectors

Operating reserve

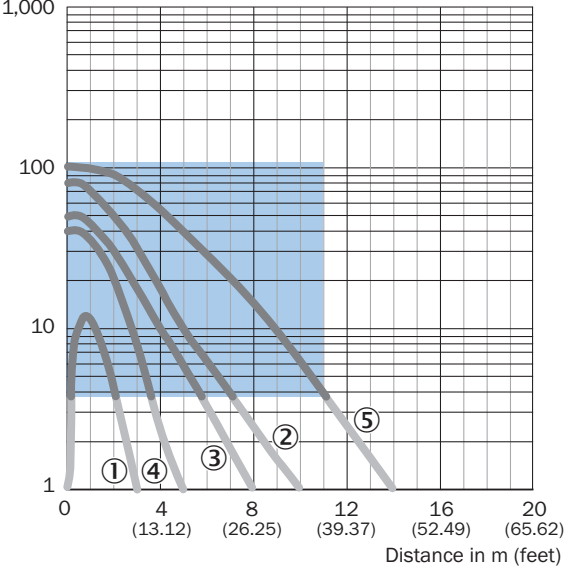

Recommended sensing range for the best performance

- ① PL10F CHEM reflector
- ② Reflector P250H
- ③ Reflector P250 CHEM
- ④ Reflector PL20 CHEM
- ⑤ Reflector PL40A Antifog

Fine triple reflectors

Operating reserve

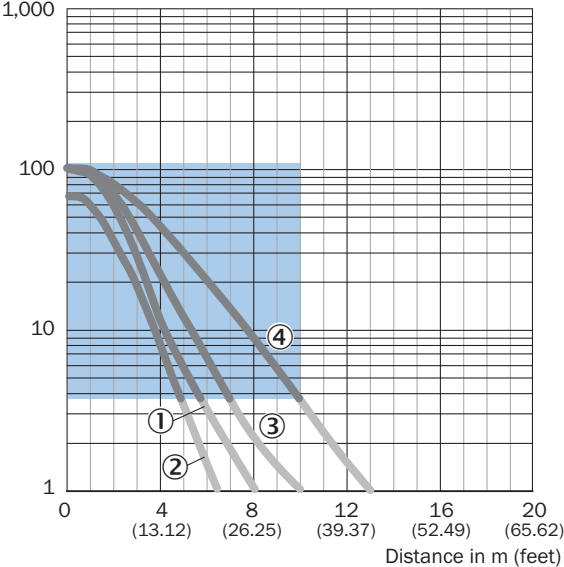

Recommended sensing range for the best performance

- ① PL10FH-1 reflector
- ② PL10F reflector
- ③ Reflector PL20F
- ④ Reflector P250F

Light spot size

WLA26P-xxxxx1xx

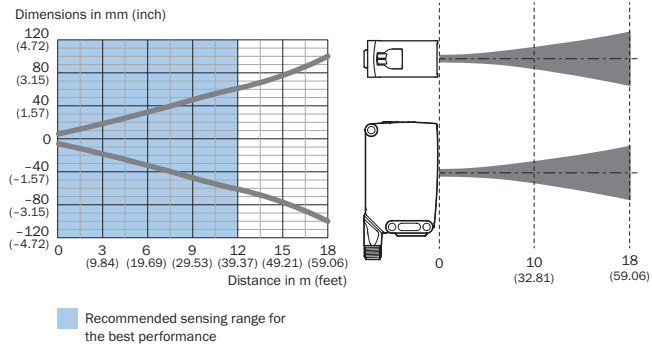

Sensing range diagram

Standard reflectors

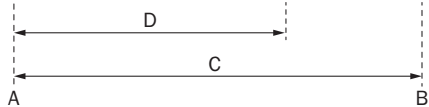
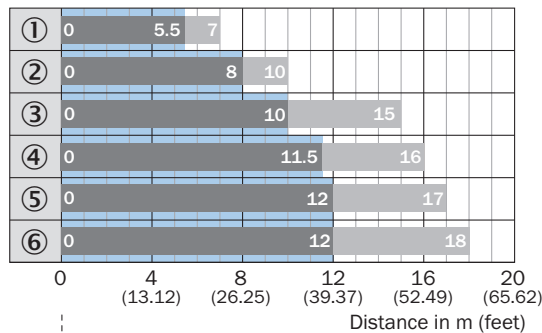

Recommended sensing range for the best performance

1	Reflector PL20A
2	Reflector PL22
3	Reflector P250
4	Reflector PL30A
5	Reflector PL40A
6	Reflector PL80A, C110A
A	Sensing range min. in m
B	Sensing range max. in m
C	Maximum distance range from reflector to sensor (operating reserve 1)
D	Recommended distance range from reflector to sensor (operating reserve 3,75)

Reflective tape

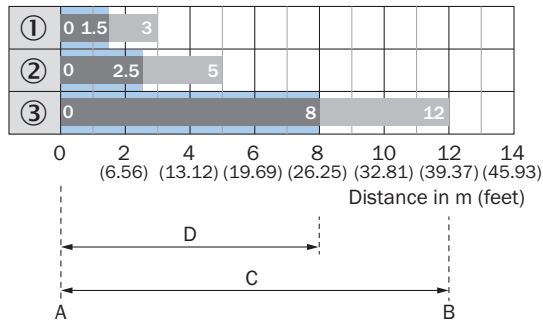

Recommended sensing range for the best performance

1	Reflective tape REF-DG (50 x 50 mm)
2	Reflective tape REF-IRF-56 (50 x 50 mm)
3	Reflective tape REF-AC1000 (50 x 50 mm)
A	Sensing range min. in m
B	Sensing range max. in m
C	Maximum distance range from reflector to sensor (operating reserve 1)
D	Recommended distance range from reflector to sensor (operating reserve 3,75)

Fine triple reflectors

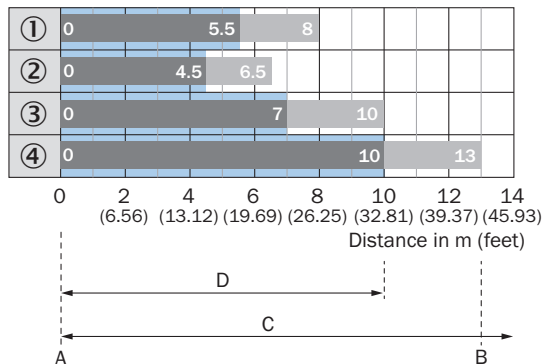

Recommended sensing range for the best performance

1	PL10FH-1 reflector
2	PL10F reflector
3	Reflector PL20F
4	Reflector P250F
A	Sensing range min. in m
B	Sensing range max. in m
C	Maximum distance range from reflector to sensor (operating reserve 1)
D	Recommended distance range from reflector to sensor (operating reserve 3,75)

Chemical-resistant reflectors

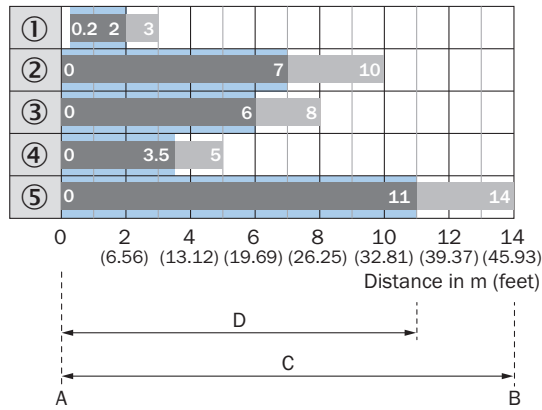

Recommended sensing range for the best performance

1	PL10F CHEM reflector
2	Reflector P250H
3	Reflector P250 CHEM
4	Reflector PL20 CHEM
5	Reflector PL40A Antifog
A	Sensing range min. in m
B	Sensing range max. in m
C	Maximum distance range from reflector to sensor (operating reserve 1)
D	Recommended distance range from reflector to sensor (operating reserve 3,75)

Functions

Operation note

BluePilot: Blue indicator LEDs with double benefits

<p>Easy and quick sensor alignment with the help of the LED indicator</p> <p>All blue LEDs illuminate</p> <ul style="list-style-type: none"> - optimum alignment - highest possible operating reserve 	<p>WLA photoelectric retro-reflection sensor alignment</p>
<p>Service note</p> <p>A reduction in sensor availability is displayed by a decrease of the blue LEDs.</p> <p>Possible causes:</p> <ul style="list-style-type: none"> a) insufficient alignment b) contamination of the optical surfaces c) particles in the light beam 	

Operation note

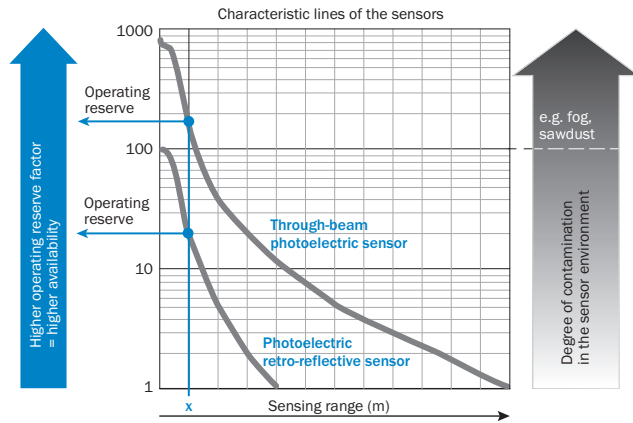

At a sensing range of „x“ the photoelectric retro-reflective and through-beam photoelectric sensors have different operating reserves (see blue arrow). The higher the operating reserve factor, the better the sensor can compensate the contamination in the air or in the light beam and on the optical surfaces (front screen, reflector), i.e. the sensor has the maximum availability, otherwise the sensor switches due to pollution although there is no object in the path of the light beam.

Recommended accessories

Other models and accessories → www.sick.com/W26

	Brief description	Type	Part no.
Universal bar clamp systems			
	Plate N12 for universal clamp. For mounting PL30A, P250 reflectors, W27 and WTR2 sensors., Zinc plated steel (sheet), Zinc die cast (clamping bracket), Universal clamp (2022726), mounting hardware	BEF-KHS-N12	2071950
Mounting brackets and plates			
	Universal mounting bracket for reflectors, steel, zinc coated	BEF-WN-REFX	2064574
Plug connectors and cables			
	Head A: female connector, M12, 4-pin, straight, A-coded Head B: Flying leads Cable: Sensor/actuator cable, PVC, unshielded, 5 m	YF2A14-050VB3XLEAX	2096235
	Head A: male connector, M12, 4-pin, straight Cable: unshielded	STE-1204-G	6009932
Reflectors			
	Rectangular, screw connection, 84 mm x 84 mm, PMMA/ABS, Screw-on, 2 hole mounting	PL80A	1003865

Recommended services

Additional services → www.sick.com/W26

	Type	Part no.
Function Block Factory		
<ul style="list-style-type: none">• Description: The Function Block Factory supports common programmable logic controllers (PLCs) from various manufacturers, such as Siemens, Beckhoff, Rockwell Automation and B&R. More information on the FBF can be found <a _blank"="" href="https://fbf.cloud.sick.com target=">here.• Note: You can configure your function block at <a _blank"="" href="https://fbf.cloud.sick.com target=">Function Block Factory. As a login please use your SICK ID.	Function Block Factory	On request

SICK AT A GLANCE

SICK is one of the leading manufacturers of intelligent sensors and sensor solutions for industrial applications. A unique range of products and services creates the perfect basis for controlling processes securely and efficiently, protecting individuals from accidents and preventing damage to the environment.

We have extensive experience in a wide range of industries and understand their processes and requirements. With intelligent sensors, we can deliver exactly what our customers need. In application centers in Europe, Asia and North America, system solutions are tested and optimized in accordance with customer specifications. All this makes us a reliable supplier and development partner.

Comprehensive services complete our offering: SICK LifeTime Services provide support throughout the machine life cycle and ensure safety and productivity.

For us, that is “Sensor Intelligence.”

WORLDWIDE PRESENCE:

Contacts and other locations –www.sick.com