



CMB30-25NPPECOSA00

CMB

CAPACITIVE PROXIMITY SENSORS

SICK
Sensor Intelligence.



Illustration may differ



Ordering information

Type	Part no.
CMB30-25NPPECOSA00	6080644

Other models and accessories → www.sick.com/CMB

Detailed technical data

Features

Housing	Cylindrical thread design
Thread size	M30 x 1.5
Diameter	Ø 30 mm
Sensing range S_n	0 mm ... 25 mm
Safe sensing range S_a	19.13 mm ¹⁾
Installation type	Non-flush
Switching frequency	50 Hz
Connection type	Male connector M12, 4-pin
Switching output	PNP
Output function	Complementary
Output characteristic	Wire configurable
Electrical wiring	DC 4-wire
Adjustment	Potentiometer, 11 turns (Sensitivity) Teach-in by wire (Sensitivity) IO-Link (Sensor parameters and Smart Task functions)
Enclosure rating	IP67 IP68 ²⁾ IP69K
Special features	Visual adjustment indicator, Smart Task, IO-Link
Pin 2 configuration	External input, Teach-in, switching signal
Items supplied	Mounting nut, PA12 plastic (2x)

¹⁾ For flush mounting in electrically conductive materials $S_a = 0.8 \times S_r$ at temperatures $<0 \text{ }^\circ\text{C}$ and $>60 \text{ }^\circ\text{C}$.

²⁾ 1 m water depth / 60 min.

Screwdriver for potentiometer adjustment (1 x)

1) For flush mounting in electrically conductive materials $S_a = 0.8 \times S_r$ at temperatures $<0 \text{ }^\circ\text{C}$ and $>60 \text{ }^\circ\text{C}$.

2) 1 m water depth / 60 min.

Mechanics/electronics

Supply voltage	10 V DC ... 36 V DC
Ripple	$\leq 10 \%$ ¹⁾
Voltage drop	$\leq 2 \text{ V DC}$ ²⁾
Current consumption	$\leq 20 \text{ mA}$ ³⁾
Time delay before availability	$\leq 300 \text{ ms}$
Hysteresis	3 % ... 20 %
Reproducibility	$\leq 5 \%$ ^{4) 5)}
Temperature drift (of S_r)	$\pm 10 \%$
EMC	EN 61000-4-2 ESD: $> 40 \text{ kV CD}$ and AD EN 61000-4-3 Radiated RF: 20 V/m EN 61000-4-4 burst: $\pm 4 \text{ kV} / 5 \text{ kHz}$ EN 61000-4-5 Surge: Voltage supply $> 2 \text{ kV}$ with 500 ohm; switching output $> 2 \text{ kV}$ with 500 ohm EN 61000-4-6 HF: $> 20 \text{ V}_{\text{rms}}$ EN 61000-4-8 mains frequency magnetic fields: Permanent $> 60 \text{ A/m}$, 75,9 μtesla ; briefly $> 600 \text{ A/m}$, 759 μtesla
Continuous current I_a	$\leq 200 \text{ mA}$
Short-circuit protection	✓
Reverse polarity protection	✓
Power-up pulse protection	✓
Shock and vibration resistance	EN 60068-2-27 shock resistance E_a : 30 g 11 ms; 3 shocks in each direction of the 3 coordinate axes IEC 60068-2-31 drop test: 2 times from 1 m, 100 times from 0.5 m EN 60068-2-6 vibration resistance F_c : 10 Hz ... 150 Hz, 1 mm / 15 g
Ambient operating temperature	$-30 \text{ }^\circ\text{C} \dots +85 \text{ }^\circ\text{C}$ ⁶⁾
Ambient temperature, storage	$-40 \text{ }^\circ\text{C} \dots +85 \text{ }^\circ\text{C}$
Housing material	Plastic, PBT
Housing length	74 mm
Thread length	45.5 mm
Tightening torque, max.	$\leq 7.5 \text{ Nm}$
UL File No.	NRKH.E191603

1) Of U_b .

2) At I_a max.

3) Without load.

4) Of S_r .

5) Supply voltage U_b and constant ambient temperature T_a .

6) $+120 \text{ }^\circ\text{C}$ short time, at the front of the sensor.

Safety-related parameters

MTTF_D	786 years
DC_{avg}	0%
T_M (mission time)	20 years

Communication interface

Communication interface	IO-Link V1.1
Communication Interface detail	COM2 (38,4 kBaud)
Cycle time	> 5 ms
Process data length	4 Byte
Process data structure	Bit 0 = switching signal Q _{L1} Bit 1 = switching signal Q _{L2} Bit 2 = Sensor switching channel Q _{int1} Bit 3 = Sensor switching channel Q _{int2} Bit 4 = Contamination alarm for switching channel Q _{int1} Bit 5 = Contamination channel for Q _{int2} Bit 6 = Temperature alarm Bit 7 = Short-circuit Bit 16 ... 31 = Analog value (digit value, not linearized)

Reduction factors

Note	The values are reference values which may vary
Metal	1
Water	1
PVC	Approx. 0.4
Oil	Approx. 0.25
Glass	0.6
Ceramics	0.5
Alcohol	0.7
Wood	0.2 ... 0.7

Installation note

Remark	Associated graphic see "Installation"
A	30 mm
B	60 mm
C	30 mm
D	75 mm
E	14.5 mm In critical distances, the sensor should be tested in the application
F	75 mm

Smart Task

Smart Task name	Base logics
Logic function	Direct AND OR Window Hysteresis
Timer function	Deactivated On delay Off delay ON and OFF delay Impulse (one shot)
Inverter	Yes
Switching signal	
Switching signal Q _{L1}	Switching output

Switching signal Q _{L2}	Switching output
----------------------------------	------------------

Classifications

eCl@ss 5.0	27270102
eCl@ss 5.1.4	27270102
eCl@ss 6.0	27270102
eCl@ss 6.2	27270102
eCl@ss 7.0	27270102
eCl@ss 8.0	27270102
eCl@ss 8.1	27270102
eCl@ss 9.0	27270102
eCl@ss 10.0	27270102
eCl@ss 11.0	27270102
eCl@ss 12.0	27274201
ETIM 5.0	EC002715
ETIM 6.0	EC002715
ETIM 7.0	EC002715
ETIM 8.0	EC002715
UNSPSC 16.0901	39122230

Installation note

Non-flush installation

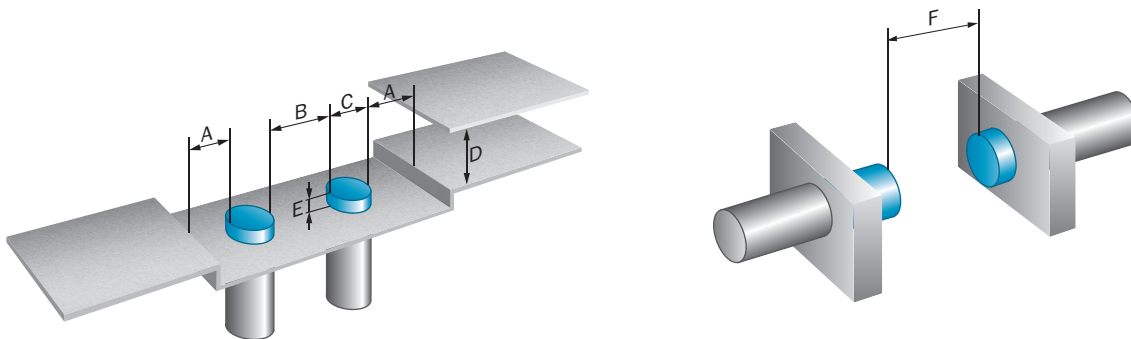

Connection diagram

Cd-526

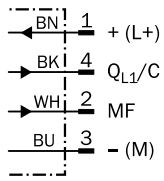

Q_{L1}/C = Switching output,
 IO-Link communication
 MF = Multifunction

Response diagram

CMB30, Non-flush installation

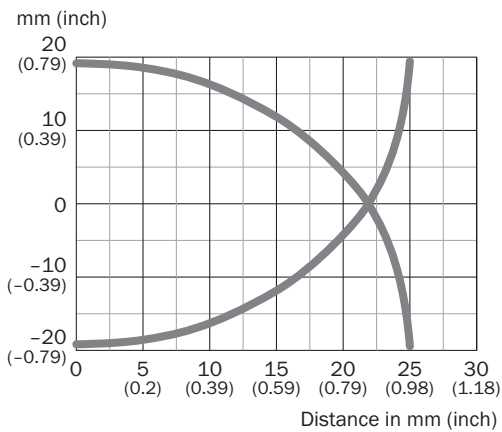

Dimensional drawing (Dimensions in mm (inch))



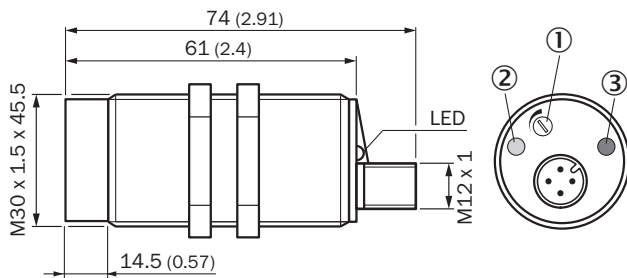



CMB30, non-flush, connector



- ① Potentiometer for sensitivity adjustment
- ② LED yellow: output active
- ③ LED green: operating indicator

Recommended accessories

Other models and accessories → www.sick.com/CMB

	Brief description	Type	Part no.
Connection modules			
	IO-Link V1.1 Class A port, USB2.0 port, optional external power supply 24V / 1A	IOLA2US-01101 (SiLink2 Master)	1061790
Mounting brackets and plates			
	Mounting plate for M30 sensors, steel, zinc coated, without mounting hardware	BEF-WG-M30	5321871
	Mounting bracket for M30 sensors, steel, zinc coated, without mounting hardware	BEF-WN-M30	5308445
Plug connectors and cables			
	Head A: female connector, M12, 4-pin, straight, A-coded Head B: Flying leads Cable: Sensor/actuator cable, PVC, unshielded, 5 m	YF2A14- 050VB3XLEAX	2096235
	Head A: male connector, M12, 4-pin, straight Cable: unshielded	STE-1204-G	6009932
Terminal and alignment brackets			
	Integrated adapter, Plastic (POM)	BEF-EA-CM30	2043770
Sensor Integration Gateway			
	<ul style="list-style-type: none"> • Further functions: Web server integrated, USB connection for easy configuration of the SIG200 Sensor Integration Gateway with SOPAS ET, the engineering tool from SICK, logic editor is available for easy configuration of logic functions • Connection CONFIG: 1 x M8, 4-pin female connector, USB 2.0 (USB-A) • Logic editor: yes • Communication interface: IO-Link, USB, Ethernet, PROFINET, REST API • Product category: IO-Link Master 	SIG200-0A0412200	1089794

SICK AT A GLANCE

SICK is one of the leading manufacturers of intelligent sensors and sensor solutions for industrial applications. A unique range of products and services creates the perfect basis for controlling processes securely and efficiently, protecting individuals from accidents and preventing damage to the environment.

We have extensive experience in a wide range of industries and understand their processes and requirements. With intelligent sensors, we can deliver exactly what our customers need. In application centers in Europe, Asia and North America, system solutions are tested and optimized in accordance with customer specifications. All this makes us a reliable supplier and development partner.

Comprehensive services complete our offering: SICK LifeTime Services provide support throughout the machine life cycle and ensure safety and productivity.

For us, that is “Sensor Intelligence.”

WORLDWIDE PRESENCE:

Contacts and other locations –www.sick.com