



# UC40-11411H

UC40

ULTRASONIC SENSORS

**SICK**  
Sensor Intelligence.



### Ordering information

Type	Part no.
UC40-11411H	6081950

**Included in delivery:** BEF-KH-IQ40 (1)

Other models and accessories → [www.sick.com/UC40](http://www.sick.com/UC40)



### Detailed technical data

#### Mechanics/electronics

<b>Supply voltage <math>V_s</math></b>	DC 9 V ... 30 V <sup>1) 2)</sup>
<b>Power consumption</b>	≤ 1.5 W <sup>3)</sup>
<b>Initialization time</b>	< 300 ms
<b>Design</b>	Rectangular
<b>Housing material</b>	Plastic (PA 66, ultrasonic transducer: polyurethane foam, glass epoxy resin)
<b>Connection type</b>	Male connector, M12, 5-pin
<b>Indication</b>	4 x LED
<b>Weight</b>	130 g
<b>Sending axis</b>	Straight <sup>4)</sup>
<b>Dimensions (W x H x D)</b>	40 mm x 40 mm x 66 mm
<b>Enclosure rating</b>	IP65 IP67
<b>Protection class</b>	III

<sup>1)</sup> Limit values, reverse-polarity protected Operation in short-circuit protected network: max. 8 A, class 2.

<sup>2)</sup> 15 V ... 30 V when using the analog voltage output.

<sup>3)</sup> Without load.

<sup>4)</sup> Sensor head can be rotated 90°, additional 360° incremental alignment via mounting bracket.

#### Performance

<b>Operating range, limiting range</b>	350 mm ... 3,400 mm, 5,000 mm
<b>Target</b>	Natural objects
<b>Resolution</b>	≥ 1 mm
<b>Repeatability</b>	± 0.15 % <sup>1)</sup>
<b>Accuracy</b>	± 1 % <sup>2) 3)</sup>
<b>Temperature compensation</b>	✓

<sup>1)</sup> In relation to the current measured value, minimum value ≥ resolution.

<sup>2)</sup> Referring to current measurement value.

<sup>3)</sup> Temperature compensation can be switched off, without temperature compensation: 0.17 % / K.

<sup>4)</sup> Subsequent smoothing of the analog output, depending on the application, may increase the response time by up to 200 %.

<b>Response time</b>	160 ms <sup>4)</sup>
<b>Switching frequency</b>	4 Hz
<b>Output time</b>	41.6 ms
<b>Ultrasonic frequency (typical)</b>	120 kHz
<b>Detection area (typical)</b>	See diagrams
<b>Additional function</b>	Adjustable operating modes: Switching point (DtO) / Switching window/Background (ObSB) Teach-in of digital output Set levels of digital outputs Invertable digital output Set on delay digital output Teach-in of analog output Scaling of analog outputs Invertable analog output Automatic selection of analog current or voltage output Analog output switchable to second digital output Synchronization of up to 50 sensors Multiplexing: no cross talk of up to 50 sensors Adjustable measurement filters: Measured value filters/Filter strength/Foreground suppression/Detection area/Sensitivity and sound beam/False echo suppression Teach-in button(s) (can be deactivated) Reset to factory default

<sup>1)</sup> In relation to the current measured value, minimum value  $\geq$  resolution.

<sup>2)</sup> Referring to current measurement value.

<sup>3)</sup> Temperature compensation can be switched off, without temperature compensation: 0.17 % / K.

<sup>4)</sup> Subsequent smoothing of the analog output, depending on the application, may increase the response time by up to 200 %.

## Interfaces

<b>IO-Link</b>	✓, IO-Link V1.1
Function	Process data, parameterization, diagnosis, data storage
<b>Digital output</b>	
Number	1 ... 2 <sup>1)</sup>
Type	Push-pull: PNP/NPN
Function	Configurable Q2 output: analog output / digital output
Maximum output current $I_A$	$\leq 100$ mA
<b>Analog output</b>	
Number	1
Type	Current output / voltage output
Function	Automatic selection of analog current or voltage output dependent on load Configurable Q2 output: analog output / digital output
Current	4 mA ... 20 mA, $\leq 500 \Omega$ <sup>2)</sup>
Voltage	0 V ... 10 V, $\geq 100,000 \Omega$
<b>Multifunctional input (MF)</b>	1 x MF
<b>Hysteresis</b>	50 mm

<sup>1)</sup> Push-pull: PNP/NPN HIGH =  $U_V - (< 3$  V) / LOW  $< 3$  V.

<sup>2)</sup> For 4 mA ... 20 mA and  $V_S \leq 20$  V max. load  $\leq 100 \Omega$ .

## Ambient data

<b>Ambient temperature, operation</b>	-25 °C ... +70 °C
<b>Ambient temperature, storage</b>	-40 °C ... +85 °C

### Classifications

<b>ECLASS 5.0</b>	27270804
<b>ECLASS 5.1.4</b>	27270804
<b>ECLASS 6.0</b>	27270804
<b>ECLASS 6.2</b>	27270804
<b>ECLASS 7.0</b>	27270804
<b>ECLASS 8.0</b>	27270804
<b>ECLASS 8.1</b>	27270804
<b>ECLASS 9.0</b>	27270804
<b>ECLASS 10.0</b>	27270804
<b>ECLASS 11.0</b>	27270804
<b>ECLASS 12.0</b>	27272806
<b>ETIM 5.0</b>	EC001846
<b>ETIM 6.0</b>	EC001846
<b>ETIM 7.0</b>	EC001846
<b>ETIM 8.0</b>	EC001846
<b>UNSPSC 16.0901</b>	41111960

### Dimensional drawing (Dimensions in mm (inch))

UC40-11411x

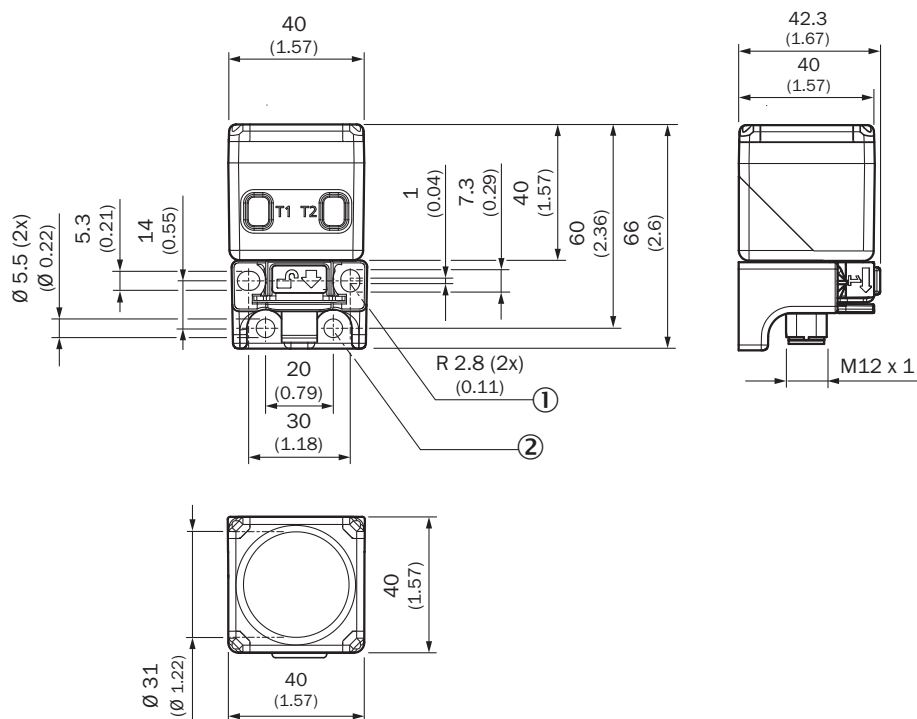

- ① 2 mounting holes, radius: 2.8 mm
- ② 2 mounting holes, diameter: 5.5 mm

## Connection type

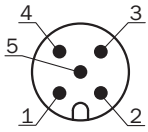

- ① L<sup>+</sup>: Supply voltage, brown
- ② N/C: Not assigned, white
- ③ M: Supply voltage 0 V, blue
- ④ Q/Q<sub>1</sub>/C: Digital output, IO-Link communication, black
- ⑤ MF: Multifunction input, synchronization and multiplex operation, communication via Connect+ software, gray

## Connection diagram

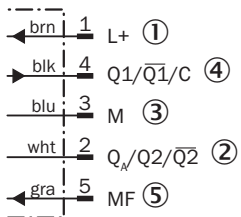

- ① Supply voltage
- ② Analog output or digital output 2
- ③ Supply voltage: 0 V
- ④ Digital output 1, IO-Link communication
- ⑤ Multifunction input (MF), synchronization and multiplex operation, communication via Connect+ software



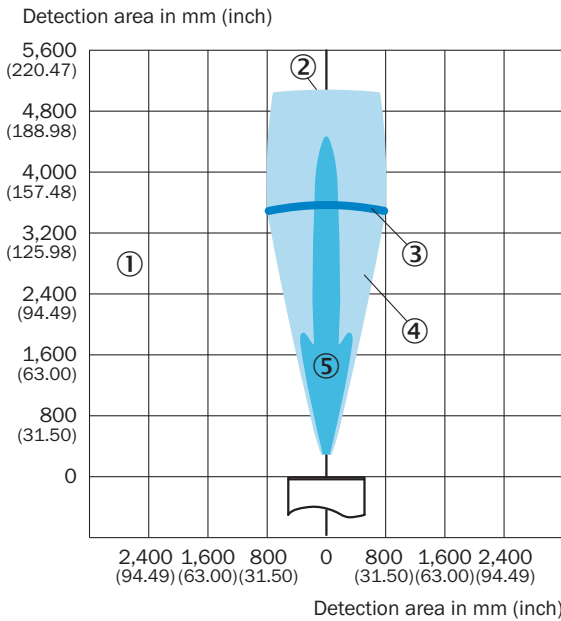

## Detection area



- ① Detection range dependent on reflection properties, size, and alignment of the object
- ② Limiting range
- ③ Operating range
- ④ Example object: aligned plate 500 mm x 500 mm
- ⑤ Example object: pipe with 27 mm diameter

### Recommended accessories

Other models and accessories → [www.sick.com/UC40](http://www.sick.com/UC40)

	Brief description	Type	Part no.
Connection modules			
	IO-Link V1.1 Class A port, USB2.0 port, optional external power supply 24V / 1A	IOLA2US-01101 (SiLink2 Master)	1061790
Plug connectors and cables			
	<ul style="list-style-type: none"> <li>• <b>Connection type head A:</b> Female connector, M12, 5-pin, straight, A-coded</li> <li>• <b>Connection type head B:</b> Flying leads</li> <li>• <b>Signal type:</b> Sensor/actuator cable</li> <li>• <b>Cable:</b> 2 m, 5-wire, PVC</li> <li>• <b>Description:</b> Sensor/actuator cable, unshielded</li> <li>• <b>Application:</b> Zones with chemicals</li> </ul>	YF2A15-020VB5XLEAX	2096239
Sensor Integration Gateway			
	<ul style="list-style-type: none"> <li>• <b>Further functions:</b> USB connection for easy configuration of the SIG100 Sensor Integration Gateway with SOPAS ET, the engineering tool from SICK, logic editor is available for easy configuration of logic functions</li> <li>• <b>I/O connection:</b> 6 x M12, 5-pin female connector, A-coded</li> <li>• <b>Connection CONFIG:</b> 1 x M8, 4-pin female connector, USB 2.0 (USB-A)</li> <li>• <b>Logic editor:</b> yes</li> <li>• <b>Communication interface:</b> USB, IO-Link</li> <li>• <b>Product category:</b> IO-Link Hub</li> </ul>	SIG100-0A0111100	1089792
	<ul style="list-style-type: none"> <li>• <b>Logic editor:</b> yes</li> <li>• <b>Communication interface:</b> PROFINET, REST API</li> <li>• <b>Product category:</b> IO-Link Master</li> </ul>	SIG200-0A041220S01	1100615

## SICK AT A GLANCE

SICK is one of the leading manufacturers of intelligent sensors and sensor solutions for industrial applications. A unique range of products and services creates the perfect basis for controlling processes securely and efficiently, protecting individuals from accidents and preventing damage to the environment.

We have extensive experience in a wide range of industries and understand their processes and requirements. With intelligent sensors, we can deliver exactly what our customers need. In application centers in Europe, Asia and North America, system solutions are tested and optimized in accordance with customer specifications. All this makes us a reliable supplier and development partner.

Comprehensive services complete our offering: SICK LifeTime Services provide support throughout the machine life cycle and ensure safety and productivity.

For us, that is “Sensor Intelligence.”

## WORLDWIDE PRESENCE:

Contacts and other locations –[www.sick.com](http://www.sick.com)