

RPH-3.0 Series \diamond Power Module

3 Amp \diamond Input: 4.5-55VDC \diamond 47 Pad QFN Package

FEATURES

- Buck regulator power module with integrated shielded inductor
- 55V maximum input voltage
- Programmable 1 - 15V output voltage
- 3A maximum output current
- SCP, OCP, OVP, and UVLO protection
- 10mm x 12mm x 4mm QFN package
- Flip-Chip technology for improved thermal management
- Efficiency up to 91%
- 3 years warranty



Dimensions (LxWxH): 10.0 x 12.0 x 4.0mm (0.394 x 0.472 x 0.157inch)
0.1g (0.0002lbs)

APPLICATIONS

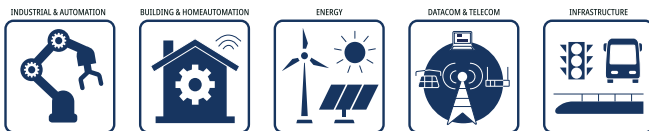

SAFETY & EMC



DESCRIPTION

The RPH-3.0 series, a cutting-edge non-isolated step-down power module, is a compact and versatile solution designed to meet challenging power conversion needs with efficiency and precision. This buck regulator power module is equipped with an integrated shielded inductor, offering a host of features to ensure optimal performance and reliability. With a maximum input voltage of 55V, this module provides a robust solution for various applications, ensuring stable and efficient voltage regulation. The output voltage is fully programmable within the range of 1 to 15V, providing flexibility to meet specific system requirements. Delivering up to 3A maximum output current, this power module is well-suited for powering a range of electronic devices and systems. Safety is a top priority, and this module comes equipped with Short Circuit Protection (SCP), Overcurrent Protection (OCP), Overvoltage Protection (OVP), and Undervoltage Lockout (UVLO) features, ensuring the longevity and protection of connected devices. The compact 10mm x 12mm x 4mm QFN package makes this power module ideal for applications with space constraints, allowing for easy integration. The use of Flip-Chip technology enhances thermal management, ensuring that the module operates efficiently even in demanding conditions. With an impressive efficiency rating of up to 91%, this non-isolated step-down power module not only meets but exceeds industry standards. This high efficiency not only contributes to reduced energy consumption but also minimizes heat generation, enhancing the overall reliability and lifespan of the module. The RPH-3.0 series is a state-of-the-art solution that combines cutting-edge technology with compact design and robust protection features for all consumer electronics, industrial applications, or any other project requiring a reliable point of load supply that delivers consistent and efficient performance.

SELECTION GUIDE

Part Number	Input Voltage Range [VDC]	Output Voltage Range [VDC]	Output Current max. [mA]	Efficiency ⁽¹⁾ typ. [%]
RPH-3.0	4.5 - 55	1 - 15	3000	91

Note1: Efficiency is tested at $V_{IN}= 24VDC$, $V_{OUT}= 12VDC$ full load at +25°C ambient

MODEL NUMBERING

RPH-3.0- _____
 max. Output Current _____ Packaging ⁽²⁾

Note2: Add suffix "-T" for tray packaging
 Add suffix "-CT" for bag packaging (refer to „Packaging Information“)

RPH-3.0 Series \diamond Power Module

3 Amp \diamond Input: 4.5-55VDC \diamond 47 Pad QFN Package

ABSOLUTE MAXIMUM RATINGS

Parameter	Symbol	Condition	Min.	Typ.	Max.
Absolute Maximum Voltage	V_{IN}				60VDC
	V_{SW}		-0.5VDC		$V_{IN} + 0.5VDC$
	V_{OUT}				16.5VDC
		others	-0.3VDC		4VDC
CTRL Sink Current					150 μ A
Maximum Continuous Power Losses ⁽³⁾		$T_{AMB} = +25^{\circ}C$			5W
Junction Temperature	T_J				+150 $^{\circ}C$
Lead Temperature					+260 $^{\circ}C$
Storage Temperature			-65 $^{\circ}C$		150 $^{\circ}C$

Note3: Exceeding maximum allowable power dissipation causes device to enter thermal shutdown which protects device from permanent damage.

Note4: Stressed beyond those listed under absolute maximum ratings can cause permanent damage to the device.

BASIC CHARACTERISTICS (measured @ $T_{AMB} = 25^{\circ}C$, $V_{IN} = 24VDC$, full load and after warm-up unless otherwise stated)

Parameter	Symbol	Condition	Min.	Typ.	Max.
Input Voltage Range	V_{IN}	refer to „Safe Operating Area“	4.5VDC		55VDC
Under Voltage Lockout UVLO		rising	3.7VDC	3.9VDC	4.1VDC
		falling	3.3VDC	3.5VDC	3.7VDC
Quiescent Current	I_Q	$V_{CTRL} = 3.3VDC$, $V_{FB} = 1.02VDC$		450 μ A	670 μ A
Recommended Input Capacitance			4.7 μ F	22 μ F	
Recommended Output Capacitance ⁽⁵⁾				47 μ F	
VDD Regulator Output Voltage			3.4VDC	3.6VDC	3.8VDC
Output Voltage Range	V_{OUT}	refer to „Safe Operating Area“	1VDC		15VDC
Peak Current Limit		10% duty cycle	5.5A	8.5A	11.5A
Feedback Voltage	V_{FB}	$4.5VDC < V_{IN} < 55VDC$	0.98VDC	1VDC	1.02VDC
Feedback Current		$V_{FB} = 1.07VDC$		10nA	50nA
Minimum On Time				90ns	
Minimum Off Time				100ns	
Soft Start				1.2ms	

Note5: The output capacitor (C_{OUT}) stabilizes the DC output voltage. Suitable types include ceramic, tantalum, or low ESR electrolytic capacitors. To ensure minimal output voltage ripple, low ESR capacitors are preferred.

Typical Application

$V_{IN} = 4.5-55VDC$, $V_{OUT} = 3.3VDC$, $I_{OUT} = 3A$

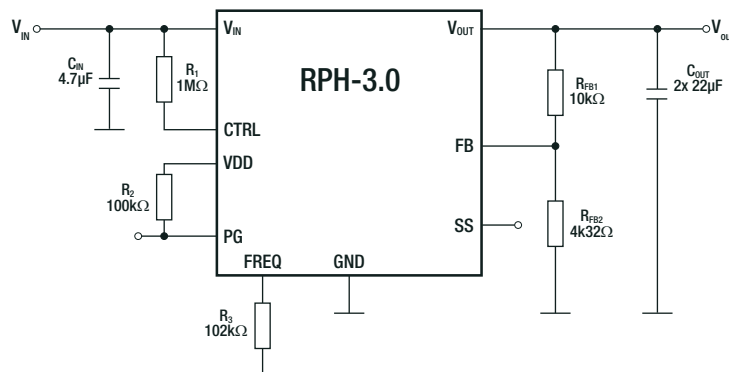

Note6: For adjustable frequency refer to „Switching Characteristics“

RPH-3.0 Series \diamond Power Module

3 Amp \diamond Input: 4.5-55VDC \diamond 47 Pad QFN Package

BASIC CHARACTERISTICS (measured @ $T_{AMB} = 25^{\circ}\text{C}$, $V_{IN} = 24\text{VDC}$, full load and after warm-up unless otherwise stated)

Safe Operating Area

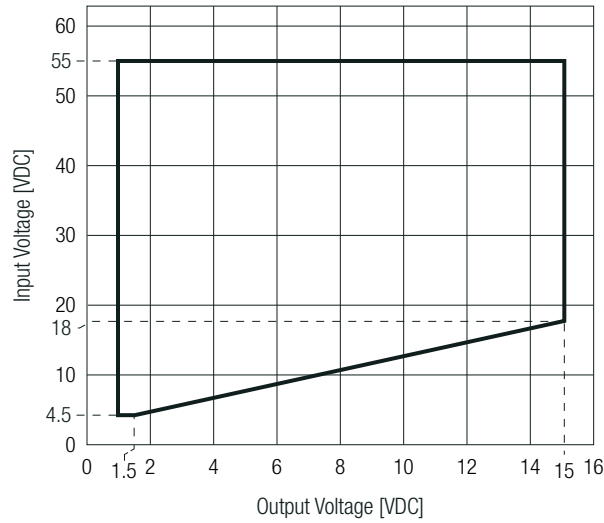

ON/OFF CTRL

Parameter	Condition	Min.	Typ.	Max.
ON/OFF CTRL	DC-DC ON			$V_{CTRL} > 1.6\text{VDC}$
	DC-DC OFF			$V_{CTRL} < 1.3\text{VDC}$
CTRL Rising Threshold		1.4VDC	1.6VDC	1.8VDC
CTRL Falling Threshold		1.1VDC	1.3VDC	1.5VDC
CTRL Hysteresis Voltage			300mV	

REGULATION

Parameter	Condition	Min.	Typ.	Max.
Load Regulation	$V_{IN} = 24\text{VDC}$, $I_{OUT} = 0\text{-}3\text{A}$		1%	
Line Regulation	$V_{IN} = 4.5\text{-}55\text{VDC}$, $I_{OUT} = 3\text{A}$		1%	

POWER GOOD OPERATING CONDITIONS

Parameter	Condition	Min.	Typ.	Max.
Threshold	V_{OUT} rising	86%	90%	94%
	V_{OUT} falling	81%	85%	89%
Hysteresis			5%	
Delay	V_{OUT} rising	8 μs	22 μs	37 μs
	V_{OUT} falling	8 μs	21 μs	33 μs

SWITCHING CHARACTERISTICS

Parameter	Symbol	Condition	Min.	Typ.	Max.
Switching Frequency	f_{SW}	$V_{OUT} = 3.3\text{VDC}$, $R_{FREQ} = 100\text{k}$	400kHz	520kHz	640kHz

Recommended Switching Frequency Values

RPH-3.0 has an externally adjustable frequency. The switching frequency (f_{SW}) can be set using a resistor at FREQ (R_{FREQ}). The Table shows recommended R_{FREQ} values for various f_{SW} values:

f_{SW}	1000	900	800	700	600	500	400	300	200	100	[kHz]
R_{FREQ}	47k5	56k	63k4	73k2	84k5	102k	133k	178k	261k	523k	[Ω]

Note7: To increase efficiency in case of low load applications, reduce operating frequency, so switching losses are lower. EMC behavior has to be considered at every frequency setpoint.

RPH-3.0 Series \diamond Power Module

3 Amp \diamond Input: 4.5-55VDC \diamond 47 Pad QFN Package

OUTPUT VOLTAGE SETTING

The RPH-3.0 series offers the feature of trimming the output voltage by using external trim resistors (see „**Typical Application**“). The external resistor divider is used to set the output voltage. The feedback resistor (R_{FB1}) cannot be too large or too small considering the trade-off for stability and dynamics. There is no strict requirement for the feedback resistor. R_{FB2} can be calculated with equation below. The values for trim resistors shown in trim tables below are according to standard E96 values; therefore, the specified voltage may slightly vary.

Feedback Network

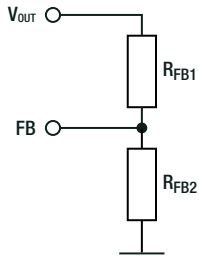

Calculation:

$$R_{FB2} = \frac{V_{fb}}{(V_{OUT} - V_{fb})} \times R_1$$

Practical example with $V_{OUT} = 1.8VDC$

$$R_{FB2} = \frac{V_{fb}}{(V_{OUT} - V_{fb})} \times R_1$$

Table below lists recommended resistor values for common V_{OUT} :

V_{OUT} [VDC]	R_{FB1} [Ω]	R_{FB2} [Ω]
1.2	10k	49k9
3.3		4k32
5.0		2k49
9.0		1k24
12.0		909

THERMAL OPERATING CONDITIONS

Parameter	Symbol	Condition	Min.	Typ.	Max.
Operating Junction Temperature	T_J	refer to „ Thermal Derating “	-40°C		+125°C
Thermal Resistance ⁽⁸⁾	$R_{th,JA}$	junction to ambient			17K/W
	$R_{th,JC}$	junction to case			3.4K/W

Note8: Test PCB= 6.4 x 6.4cm double sided PCB with 20oz copper, natural convection

ENVIRONMENTAL

Parameter	Condition	Value
Moisture Sensitive Level		Level 3

PROTECTIONS

Parameter	Condition	Value	
Short Circuit Protection (SCP)		hiccup, auto recovery	
Over Current Protection (OCP)		hiccup, auto recovery	
Over Voltage Protection (OVP)		latch off, 108% - 122% max.	
Thermal Shutdown	restart after cooldown	junction temperature	170°C typ.
		hysteresis	10°C typ.

TYPICAL PERFORMANCE CHARACTERISTICS

3.3Vout

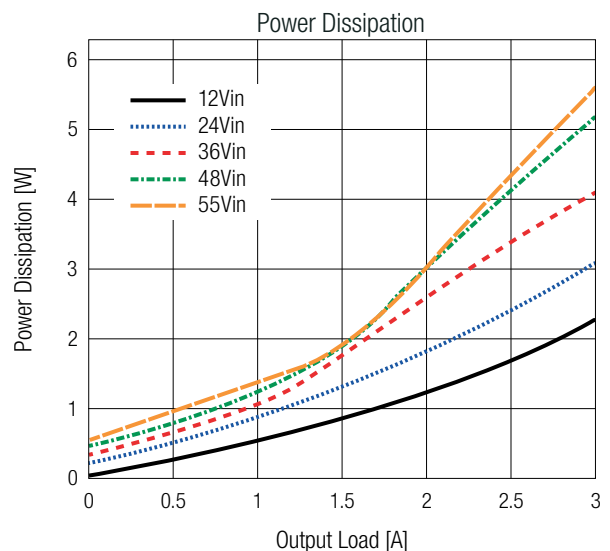
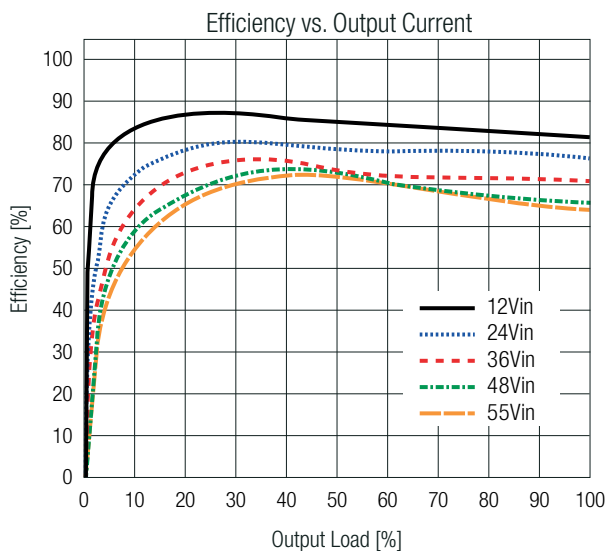

RPH-3.0 Series \diamond Power Module

3 Amp \diamond Input: 4.5-55VDC \diamond 47 Pad QFN Package

TYPICAL PERFORMANCE CHARACTERISTICS

3.3Vout

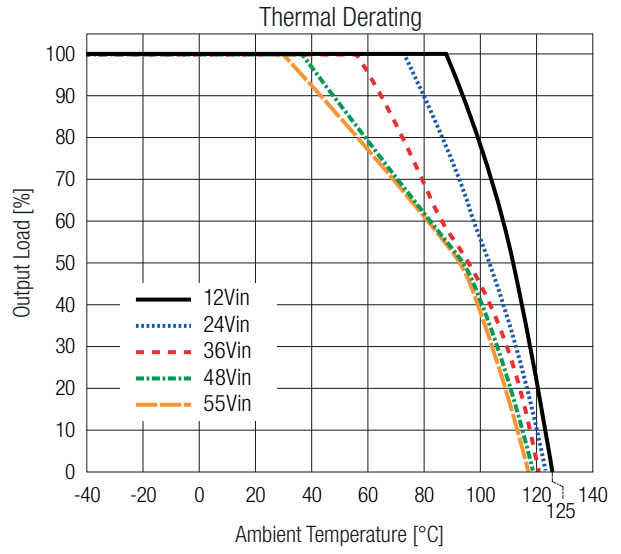
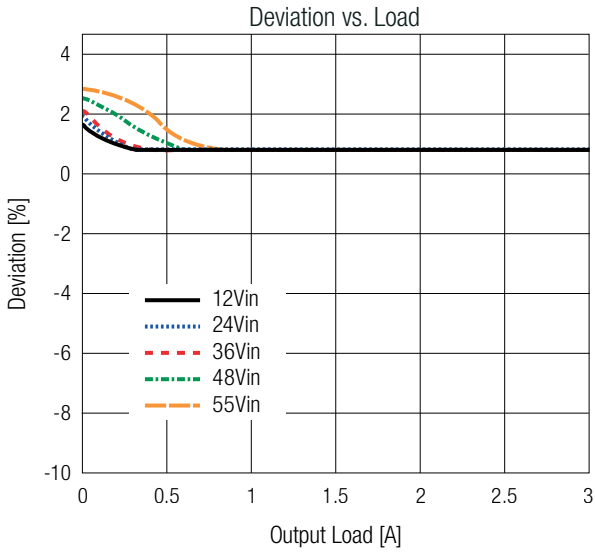

12Vout

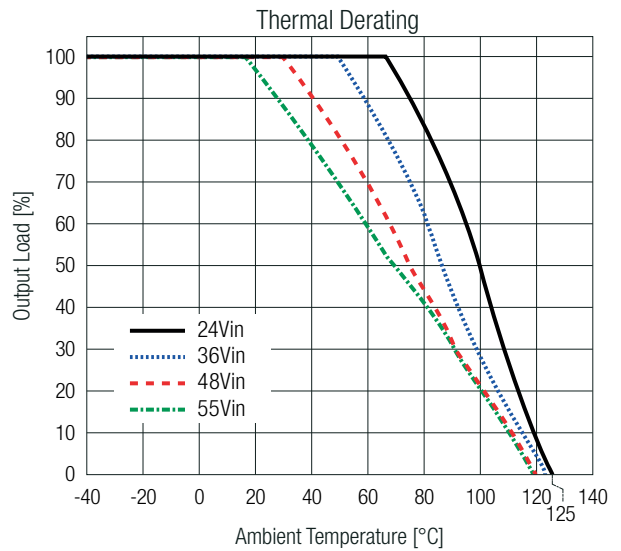
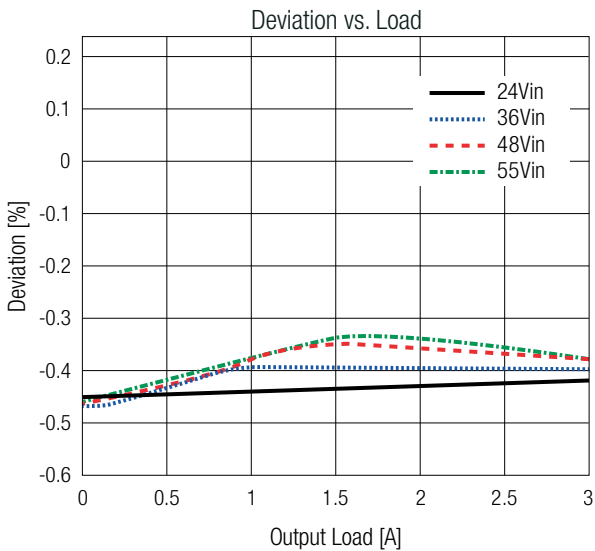
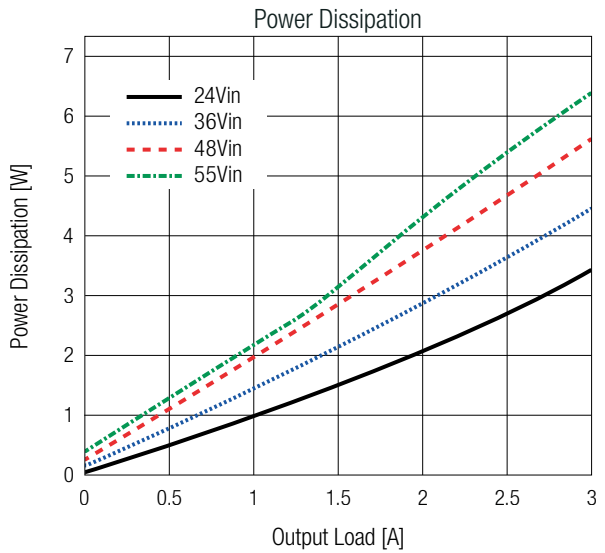
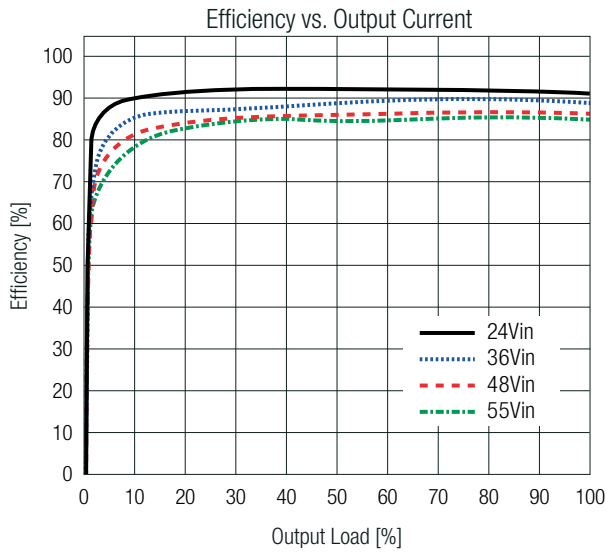

RPH-3.0 Series \diamond Power Module

3 Amp \diamond Input: 4.5-55VDC \diamond 47 Pad QFN Package

SAFETY & CERTIFICATIONS

Certificate Type (Safety)	Report Number	Standard
RoHS2		RoHS 2011/65EU + AM2015/863

DIMENSION & PHYSICAL CHARACTERISTICS

Parameter	Type	Value
Material	case	plastic
Dimension (LxWxH)		10.0 x 12.0 x 4.0mm 0.394 x 0.472 x 0.157inch
Weight		0.1g typ. 0.0002lbs

Dimension Drawing (mm)

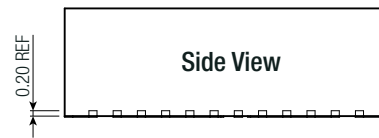
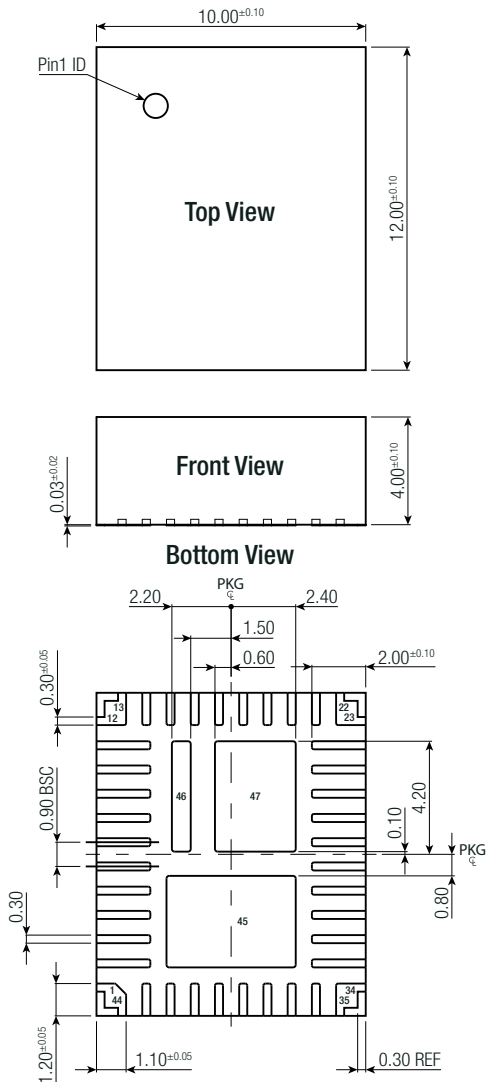
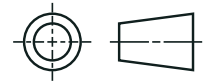

Recommended Footprint Details (Top View)

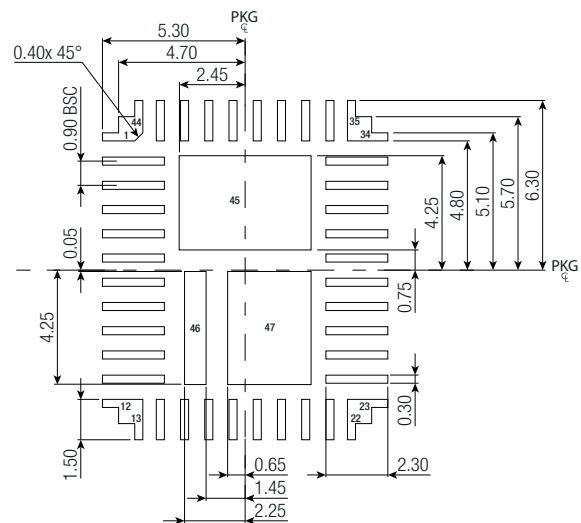

Tolerances:
 x.x= ±0.1mm
 x.xx= ±0.05mm

RPH-3.0 Series \diamond Power Module

3 Amp \diamond Input: 4.5-55VDC \diamond 47 Pad QFN Package

PAD INFORMATION

Pad Information

Pad #	Function	Description
1, 42-44	V _{IN}	Input supply. VIN supplies power to all of the internal control circuitries and the VDD regulator. Place a decoupling capacitor to ground close to V _{IN} to minimize switching spikes. Use wide traces to connect V _{IN} .
2, 12-16, 30, 38, 41, 45, 46	GND	Module power ground pin.
3	BST	Bootstrap. BST is the positive power supply for the internal floating high-side MOSFET driver. Keep BST floating.
4-11	SW	Switch output. Keep SW floating.
17-28, 47	OUT	Module voltage output mode. Use wide traces to connect OUT.
29	VDD	Power for internal MOSFET driver and BST charging circuit.
31	PG	Power good indication. Connect a resistor from PG to a pull-up power source if it is being used.
32	SS	Soft start. Float SS for a default 1.2ms SS time. The SS time can be extended by connecting an external capacitor between SS and AGND.
33-35	GND	Ground for internal logic and signal circuit.
36	COMP	Compensation networks setting. Connect an external resistor series with a capacitor between COMP and AGND.
37	FB	Feedback. FB is the input to the PWM comparator. Connect an external resistor divider between the output and AGND.
39	FREQ	Frequency set pin. Connect a resistor from FREQ to ground to set the switching frequency. If an external SYNC clock is applied to FREQ, the converter follows this SYNC clock frequency.
40	CTRL	Enable input. Pull CTRL below the specified threshold to shut down the chip. There is no internal pull-up or pull-down circuit, so CTRL cannot be floated. CTRL is a pin that turns the module on and off. Drive CTRL above 1.6V to turn on the regulator. Drive CTRL below 1.3V to turn off the regulator.

PACKAGING INFORMATION

Parameter	Type	Value
Packaging Dimension (LxWxH)	Suffix -T: tray	392 x 160 x 98mm
		15.43 x 6.3 x 3.86inch
	Suffix -CT: moisture barrier bag	152 x 102 x 30mm
Packaging Quantity	Suffix -T: tray	210pcs
	Suffix -CT: moisture barrier bag	20pcs
Storage Temperature Range		-65°C to +150°C
Storage Humidity	non-condensing	60% RH max.

The product information and specifications may be subject to changes even without prior written notice. The product has been designed for various applications; its suitability lies in the responsibility of each customer. The products are not authorized for use in safety-critical applications without RECOM's explicit written consent. A safety-critical application is an application where a failure may reasonably be expected to endanger or cause loss of life, inflict bodily harm or damage property. The applicant shall indemnify and hold harmless RECOM, its affiliated companies and its representatives against any damage claims in connection with the unauthorized use of RECOM products in such safety-critical applications.