



# WL250-2P1131

W250-2

COMPACT PHOTOELECTRIC SENSORS

**SICK**  
Sensor Intelligence.



Illustration may differ



## Ordering information

Type	Part no.
WL250-2P1131	6044697

**Included in delivery:** BEF-W250 (1), P250 (1)

Other models and accessories → [www.sick.com/W250-2](http://www.sick.com/W250-2)

## Detailed technical data

### Features

<b>Functional principle</b>	Photoelectric retro-reflective sensor
<b>Functional principle detail</b>	Dual lens
<b>Dimensions (W x H x D)</b>	20 mm x 65 mm x 43.9 mm
<b>Housing design (light emission)</b>	Rectangular
<b>Sensing range max.</b>	0.01 m ... 15 m <sup>1)</sup> 0.01 m ... 12 m <sup>2)</sup>
<b>Sensing range</b>	0.01 m ... 13 m <sup>1)</sup> 0.01 m ... 11 m <sup>2)</sup>
<b>Focus</b>	Approx. 2°
<b>Type of light</b>	Visible red light
<b>Light source</b>	LED <sup>3)</sup>
<b>Light spot size (distance)</b>	Ø 260 mm (8 m)
<b>Angle of dispersion</b>	Approx. 2°
<b>Adjustment</b>	Potentiometer, 2 turns <sup>4)</sup>

<sup>1)</sup> Reflector PL80A.

<sup>2)</sup> Reflector P250.

<sup>3)</sup> Average service life: 100,000 h at T<sub>J</sub> = +25 °C.

<sup>4)</sup> With position indicator.

## Mechanics/electronics

<b>Supply voltage <math>U_B</math></b>	10 V DC ... 30 V DC <sup>1)</sup>
<b>Ripple</b>	< 5 V <sub>pp</sub> <sup>2)</sup>
<b>Current consumption</b>	20 mA <sup>3)</sup>
<b>Switching output</b>	PNP
<b>Switching mode</b>	Light/dark switching
<b>Switching mode selector</b>	Selectable via L/D control cable
<b>Output current <math>I_{max}</math></b>	≤ 100 mA
<b>Response time</b>	≤ 0.5 ms <sup>4)</sup>
<b>Switching frequency</b>	1,000 Hz <sup>5)</sup>
<b>Connection type</b>	Cable, 4-wire, 2 m <sup>6)</sup>
<b>Cable material</b>	PVC
<b>Conductor cross section</b>	0.18 mm <sup>2</sup>
<b>Cable diameter</b>	Ø 3.8 mm
<b>Circuit protection</b>	A <sup>7)</sup> B <sup>8)</sup> C <sup>9)</sup> D <sup>10)</sup>
<b>Protection class</b>	III
<b>Weight</b>	150 g
<b>Polarisation filter</b>	✓
<b>Housing material</b>	Plastic, ABS
<b>Optics material</b>	Plastic, PMMA
<b>Enclosure rating</b>	IP67
<b>Items supplied</b>	Reflector P250, BEF-W250 mounting bracket
<b>Electromagnetic compatibility (EMC)</b>	EN 60947-5-2 <sup>11)</sup>
<b>Ambient operating temperature</b>	-25 °C ... +55 °C
<b>Ambient temperature, storage</b>	-40 °C ... +70 °C
<b>UL File No.</b>	NRKH2.E300503 & NRKH8.E300503

<sup>1)</sup> Limit values when operated in short-circuit protected network: max. 8 A.

<sup>2)</sup> May not exceed or fall below  $U_V$  tolerances.

<sup>3)</sup> Without load.

<sup>4)</sup> Signal transit time with resistive load.

<sup>5)</sup> With light/dark ratio 1:1.

<sup>6)</sup> Do not bend below 0 °C.

<sup>7)</sup> A =  $V_S$  connections reverse-polarity protected.

<sup>8)</sup> B = inputs and output reverse-polarity protected.

<sup>9)</sup> C = interference suppression.

<sup>10)</sup> D = outputs overcurrent and short-circuit protected.

<sup>11)</sup> The AC/DC devices comply with the Radio Safety Requirements for the industrial sector (Radio Safety Class A). They may cause radio interference if used in a residential area.

## Safety-related parameters

<b>MTTF<sub>D</sub></b>	1,686 years
<b>DC<sub>avg</sub></b>	0 %

## Classifications

<b>eCl@ss 5.0</b>	27270902
<b>eCl@ss 5.1.4</b>	27270902
<b>eCl@ss 6.0</b>	27270902
<b>eCl@ss 6.2</b>	27270902
<b>eCl@ss 7.0</b>	27270902
<b>eCl@ss 8.0</b>	27270902
<b>eCl@ss 8.1</b>	27270902
<b>eCl@ss 9.0</b>	27270902
<b>eCl@ss 10.0</b>	27270902
<b>eCl@ss 11.0</b>	27270902
<b>eCl@ss 12.0</b>	27270902
<b>ETIM 5.0</b>	EC002717
<b>ETIM 6.0</b>	EC002717
<b>ETIM 7.0</b>	EC002717
<b>ETIM 8.0</b>	EC002717
<b>UNSPSC 16.0901</b>	39121528

## Adjustments

WL250-2

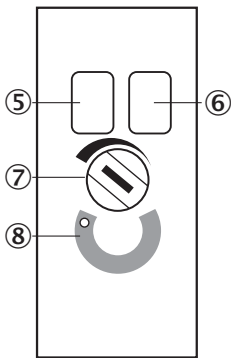

- ⑤ LED indicator green: Stability indicator
- ⑥ LED indicator yellow: Status of received light beam
- ⑦ Sensitivity control: potentiometer
- ⑧ Position indicator for sensitivity setting (270°)

## Connection diagram

Cd-089

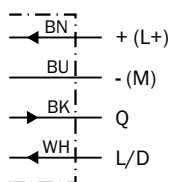

### Characteristic curve

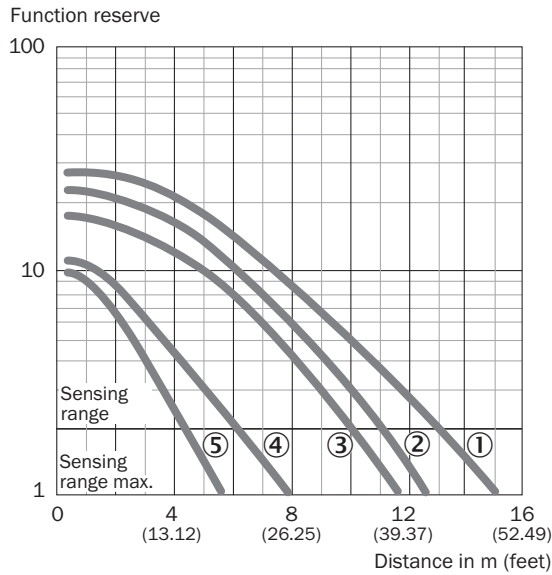

- ① Reflector PL80A, C110A
- ② Reflector P250
- ③ Reflector PL50A, PL40A, PL30A, PL31A
- ④ Reflector PL20A
- ⑤ Diamond Grade reflective tape, 100 mm x 100 mm

### Sensing range diagram

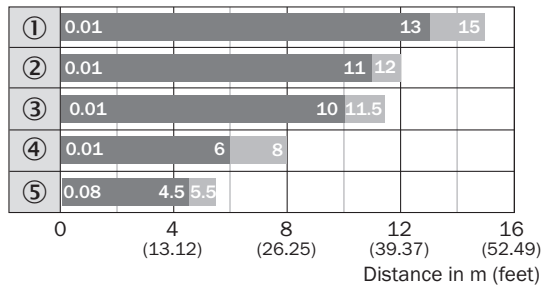

- Sensing range
- Sensing range max.
- ① Reflector PL80A, C110A
- ② Reflector P250
- ③ Reflector PL50A, PL40A, PL30A, PL31A
- ④ Reflector PL20A
- ⑤ Diamond Grade reflective tape, 100 mm x 100 mm

**Dimensional drawing** (Dimensions in mm (inch))

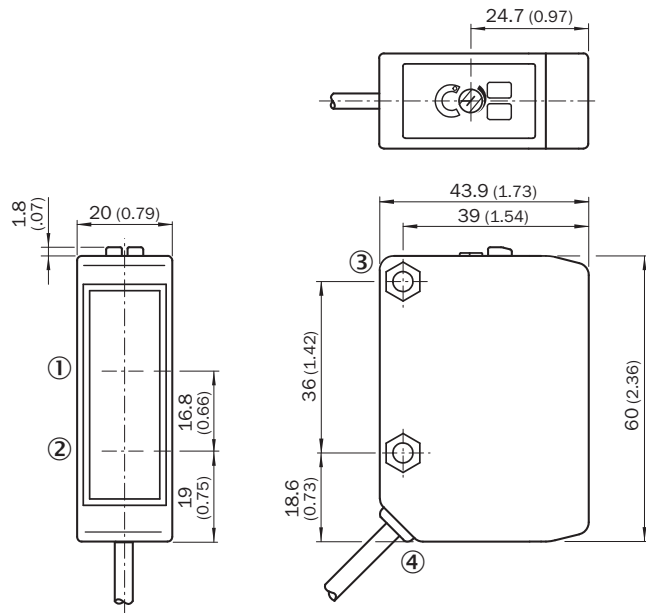

WL250-2, DC, cable



- ① Reception axis
- ② Axis of sender
- ③ Mounting hole  $\varnothing$  4.2 mm, for M4 hexagon nuts on both sides
- ④ Connection cable

**Recommended accessories**

Other models and accessories → [www.sick.com/W250-2](http://www.sick.com/W250-2)

	Brief description	Type	Part no.
<b>Mounting brackets and plates</b>			
	Universal mounting bracket for reflectors, steel, zinc coated	BEF-WN-REFX	2064574
<b>Plug connectors and cables</b>			
	Head A: male connector, M12, 4-pin, straight Cable: unshielded	STE-1204-G	6009932
<b>Reflectors</b>			
	Rectangular, screw connection, 51 mm x 61 mm, PMMA/ABS, Screw-on, 2 hole mounting	P250	5304812

## SICK AT A GLANCE

SICK is one of the leading manufacturers of intelligent sensors and sensor solutions for industrial applications. A unique range of products and services creates the perfect basis for controlling processes securely and efficiently, protecting individuals from accidents and preventing damage to the environment.

We have extensive experience in a wide range of industries and understand their processes and requirements. With intelligent sensors, we can deliver exactly what our customers need. In application centers in Europe, Asia and North America, system solutions are tested and optimized in accordance with customer specifications. All this makes us a reliable supplier and development partner.

Comprehensive services complete our offering: SICK LifeTime Services provide support throughout the machine life cycle and ensure safety and productivity.

For us, that is “Sensor Intelligence.”

## WORLDWIDE PRESENCE:

Contacts and other locations –[www.sick.com](http://www.sick.com)