



# WL34-B430S03

W34

COMPACT PHOTOELECTRIC SENSORS

**SICK**  
Sensor Intelligence.



## Ordering information

Type	Part no.
WL34-B430S03	1027858

Other models and accessories → [www.sick.com/W34](http://www.sick.com/W34)

Illustration may differ



## Detailed technical data

### Features

<b>Functional principle</b>	Photoelectric retro-reflective sensor
<b>Functional principle detail</b>	Dual lens
<b>Dimensions (W x H x D)</b>	27 mm x 92 mm x 70 mm
<b>Housing design (light emission)</b>	Rectangular
<b>Sensing range max.</b>	0.03 m ... 22 m <sup>1)</sup>
<b>Sensing range</b>	0.03 m ... 15 m <sup>1)</sup>
<b>Type of light</b>	Visible red light
<b>Light source</b>	LED <sup>2)</sup>
<b>Light spot size (distance)</b>	Ø 250 mm (15 m)
<b>Wave length</b>	660 nm
<b>Adjustment</b>	Potentiometer
<b>Special features</b>	No test input TE

<sup>1)</sup> Reflector PL80A.

<sup>2)</sup> Average service life: 100,000 h at T<sub>J</sub> = +25 °C.

### Mechanics/electronics

<b>Supply voltage</b>	10 V DC ... 30 V DC <sup>1)</sup>
<b>Ripple</b>	< 5 V <sub>pp</sub> <sup>2)</sup>
<b>Current consumption</b>	50 mA

<sup>1)</sup> Limit values.

<sup>2)</sup> May not exceed or fall below U<sub>v</sub> tolerances.

<sup>3)</sup> Signal transit time with resistive load.

<sup>4)</sup> With light/dark ratio 1:1.

<sup>5)</sup> A = V<sub>S</sub> connections reverse-polarity protected.

<sup>6)</sup> C = interference suppression.

<sup>7)</sup> D = outputs overcurrent and short-circuit protected.

<sup>8)</sup> Reference voltage: 50 V DC.

<b>Switching output</b>	NPN PNP
<b>Switching mode</b>	Light switching Dark switching
<b>Switching mode selector</b>	Selectable via PNP/NPN selector, selectable via light/dark selector
<b>Output current <math>I_{\max}</math></b>	$\leq 100$ mA
<b>Response time</b>	$\leq 500$ $\mu$ s <sup>3)</sup>
<b>Switching frequency</b>	1,000 Hz <sup>4)</sup>
<b>Connection type</b>	Male connector M12, 4-pin
<b>Circuit protection</b>	A <sup>5)</sup> C <sup>6)</sup> D <sup>7)</sup>
<b>Protection class</b>	II <sup>8)</sup>
<b>Weight</b>	140 g
<b>Polarisation filter</b>	✓
<b>Special device</b>	✓
<b>Housing material</b>	Plastic, ABS
<b>Enclosure rating</b>	IP67
<b>Ambient operating temperature</b>	-40 °C ... +60 °C
<b>Ambient temperature, storage</b>	-40 °C ... +75 °C
<b>UL File No.</b>	NRKH.E181493 & NRKH7.E181493

1) Limit values.

2) May not exceed or fall below  $U_v$  tolerances.

3) Signal transit time with resistive load.

4) With light/dark ratio 1:1.

5) A =  $V_S$  connections reverse-polarity protected.

6) C = interference suppression.

7) D = outputs overcurrent and short-circuit protected.

8) Reference voltage: 50 V DC.

## Classifications

<b>eCl@ss 5.0</b>	27270902
<b>eCl@ss 5.1.4</b>	27270902
<b>eCl@ss 6.0</b>	27270902
<b>eCl@ss 6.2</b>	27270902
<b>eCl@ss 7.0</b>	27270902
<b>eCl@ss 8.0</b>	27270902
<b>eCl@ss 8.1</b>	27270902
<b>eCl@ss 9.0</b>	27270902
<b>eCl@ss 10.0</b>	27270902
<b>eCl@ss 11.0</b>	27270902
<b>eCl@ss 12.0</b>	27270902
<b>ETIM 5.0</b>	EC002717
<b>ETIM 6.0</b>	EC002717
<b>ETIM 7.0</b>	EC002717

<b>ETIM 8.0</b>	EC002717
<b>UNSPSC 16.0901</b>	39121528

### Connection type



### Connection diagram

Cd-076

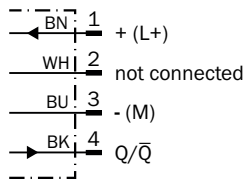

### Characteristic curve

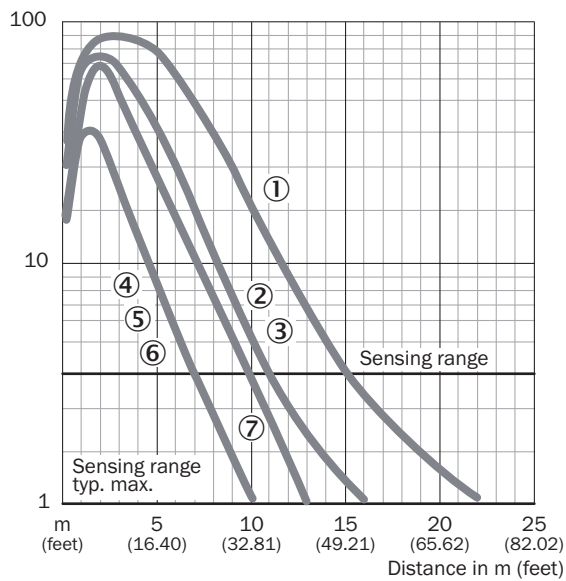

- ① Reflector PL80A
- ② Reflector PL50A
- ③ Reflector PL40A
- ④ Reflector PL30A
- ⑤ Reflector PL20A
- ⑥ Reflective tape Diamond Grade
- ⑦ Reflector C110A

### Sensing range diagram

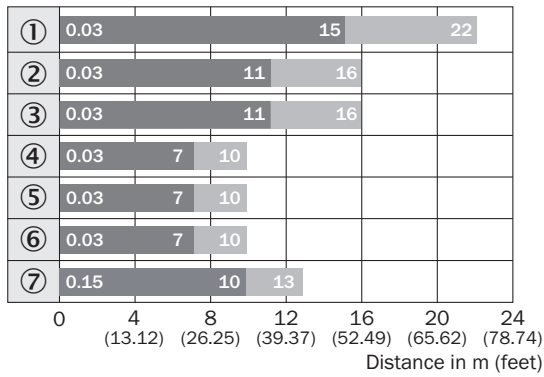

■ Sensing range      ■ Sensing range max.

- ① Reflector PL80A
- ② Reflector PL50A
- ③ Reflector PL40A
- ④ Reflector PL30A
- ⑤ Reflector PL20A
- ⑥ Reflective tape Diamond Grade
- ⑦ Reflector C110A

### Adjustments

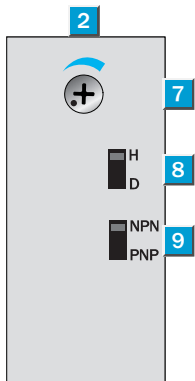

- ② LED signal strength indicator
- ⑦ Sensitivity control
- ⑧ Light/dark selector
- ⑨ NPN/PNP changeover switch



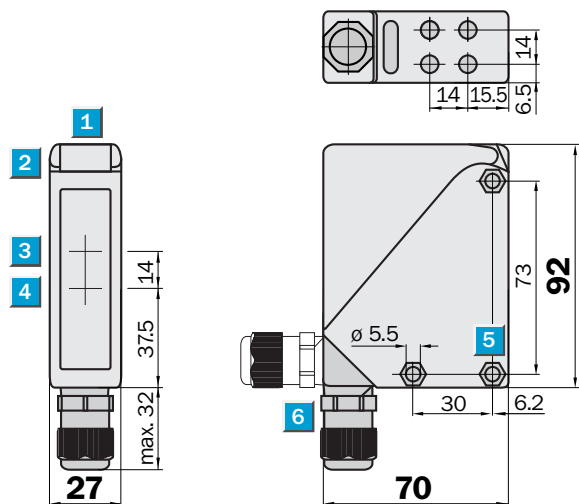

Dimensional drawing (Dimensions in mm (inch))



- ① Alignment sight
- ② LED signal strength indicator
- ③ Center of optical axis, sender
- ④ Center of optical axis, receiver
- ⑤ Mounting hole  $\varnothing$  5.5 mm, for M5 hexagon nuts on both sides
- ⑥ M16 screw fixing rotatable by 90°

Recommended accessories

Other models and accessories → [www.sick.com/W34](http://www.sick.com/W34)

	Brief description	Type	Part no.
<b>Mounting brackets and plates</b>			
	Universal mounting bracket for reflectors, steel, zinc coated	BEF-WN-REFX	2064574
	Mounting bracket, Stainless steel (1.4301), mounting hardware included	BEF-WN-W24	2015248
<b>Plug connectors and cables</b>			
	Head A: female connector, M12, 4-pin, straight, A-coded Head B: Flying leads Cable: Sensor/actuator cable, PVC, unshielded, 5 m	YF2A14-050VB3XLEAX	2096235
	Head A: male connector, M12, 4-pin, straight Cable: unshielded	STE-1204-G	6009932
<b>Reflectors</b>			
	Rectangular, screw connection, 84 mm x 84 mm, PMMA/ABS, Screw-on, 2 hole mounting	PL80A	1003865

## SICK AT A GLANCE

SICK is one of the leading manufacturers of intelligent sensors and sensor solutions for industrial applications. A unique range of products and services creates the perfect basis for controlling processes securely and efficiently, protecting individuals from accidents and preventing damage to the environment.

We have extensive experience in a wide range of industries and understand their processes and requirements. With intelligent sensors, we can deliver exactly what our customers need. In application centers in Europe, Asia and North America, system solutions are tested and optimized in accordance with customer specifications. All this makes us a reliable supplier and development partner.

Comprehensive services complete our offering: SICK LifeTime Services provide support throughout the machine life cycle and ensure safety and productivity.

For us, that is “Sensor Intelligence.”

## WORLDWIDE PRESENCE:

Contacts and other locations –[www.sick.com](http://www.sick.com)