



RT-B1221

ZoneControl

MULTITASK PHOTOELECTRIC SENSORS

SICK
Sensor Intelligence.



Illustration may differ



Ordering information

Type	Part no.
RT-B1221	1063174

Other models and accessories → www.sick.com/ZoneControl

Detailed technical data

Features

Functional principle	Photoelectric proximity sensor
Functional principle detail	Background suppression
Dimensions (W x H x D)	20.6 mm x 99.2 mm x 48.9 mm
Sensing range max.	60 mm ... 900 mm
Sensing range	60 mm ... 900 mm
Focus	7°
Type of light	Infrared light
Light source	LED ¹⁾
Light spot size (distance)	Ø 20 mm (500 mm)
Angle of dispersion	7°
Adjustment	Potentiometer, 9 turns
Special applications	ZoneControl

¹⁾ Average service life: 100,000 h at T_J = +25 °C.

Mechanics/electronics

Supply voltage U_B	10 V DC ... 30 V DC ¹⁾
Ripple	< 5 V _{pp} ²⁾
Current consumption	20 mA ³⁾
Switching output	PNP, NPN

¹⁾ Limit values.

²⁾ May not exceed or fall below U_v tolerances.

³⁾ Without load and valve deenergized.

⁴⁾ A = V_S connections reverse-polarity protected.

⁵⁾ C = interference suppression.

⁶⁾ D = outputs overcurrent and short-circuit protected.

Switching mode	Light switching
Signal voltage PNP HIGH/LOW	Approx. $V_S - 0.5 \text{ V} / 0 \text{ V}$
Signal voltage NPN HIGH/LOW	Approx. $V_S / < 2.0 \text{ V}$
Output current I_{max}	$\leq 100 \text{ mA}$
Response time	2 ms
Switching frequency	250 Hz
Connection type	Male connector M12, 4-pin
Circuit protection	A ⁴⁾ C ⁵⁾ D ⁶⁾
Protection class	III
Weight	175 g
Housing material	Plastic, ABS
Enclosure rating	IP67
Shock and vibration resistance	According to IEC 68
Ambient operating temperature	-40 °C ... +60 °C
Ambient temperature, storage	-40 °C ... +75 °C
UL File No.	NRKH.E189383 & NRKH7.E189383

1) Limit values.

2) May not exceed or fall below U_V tolerances.

3) Without load and valve deenergized.

4) A = V_S connections reverse-polarity protected.

5) C = interference suppression.

6) D = outputs overcurrent and short-circuit protected.

Safety-related parameters

MTTF_D	1,525 years
DC_{avg}	0 %

Classifications

ECLASS 5.0	27270904
ECLASS 5.1.4	27270904
ECLASS 6.0	27270904
ECLASS 6.2	27270904
ECLASS 7.0	27270904
ECLASS 8.0	27270904
ECLASS 8.1	27270904
ECLASS 9.0	27270904
ECLASS 10.0	27270904
ECLASS 11.0	27270904
ECLASS 12.0	27270903
ETIM 5.0	EC002719
ETIM 6.0	EC002719
ETIM 7.0	EC002719

ETIM 8.0	EC002719
UNSPSC 16.0901	39121528

Connection diagram

Cd-256

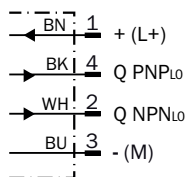

Characteristic curve

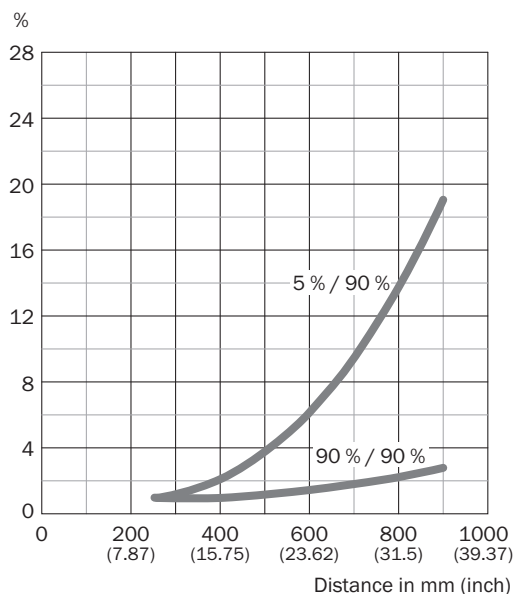

Light spot size

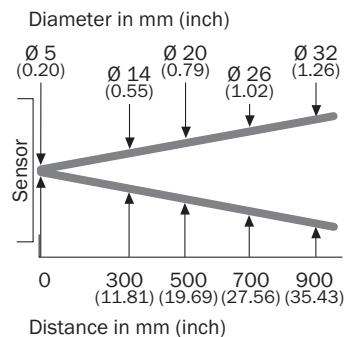

Dimensional drawing (Dimensions in mm (inch))



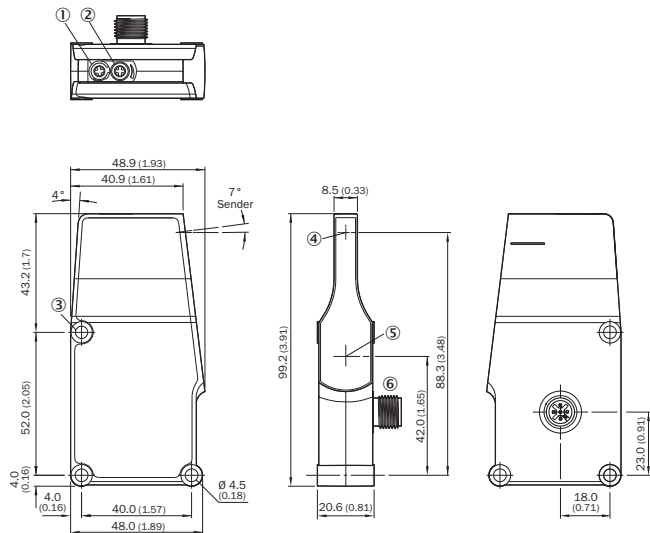

R / IR without valve



- ① LED
- ② Potentiometer
- ③ Fixing hole
- ④ Center of optical axis, sender
- ⑤ Center of optical axis, receiver
- ⑥ Male connector M12, 4-pin

Recommended accessories

Other models and accessories → www.sick.com/ZoneControl

	Brief description	Type	Part no.
Mounting brackets and plates			
	Mounting bracket, steel, zinc coated, mounting hardware included	BEF-WK-WTR	2051786
		BEF-WN-RT/IRT	2074621
Plug connectors and cables			
	<ul style="list-style-type: none"> • Connection type head A: Female connector, M12, 4-pin, straight, A-coded • Connection type head B: Flying leads • Signal type: Sensor/actuator cable • Cable: 5 m, 4-wire, PVC • Description: Sensor/actuator cable, unshielded • Application: Zones with chemicals 	YF2A14-050VB3XLEAX	2096235
		<ul style="list-style-type: none"> • Connection type head A: Male connector, M12, 4-pin, straight • Description: Unshielded • Connection systems: Screw-type terminals • Permitted cross-section: ≤ 0.75 mm² 	STE-1204-G

SICK AT A GLANCE

SICK is one of the leading manufacturers of intelligent sensors and sensor solutions for industrial applications. A unique range of products and services creates the perfect basis for controlling processes securely and efficiently, protecting individuals from accidents and preventing damage to the environment.

We have extensive experience in a wide range of industries and understand their processes and requirements. With intelligent sensors, we can deliver exactly what our customers need. In application centers in Europe, Asia and North America, system solutions are tested and optimized in accordance with customer specifications. All this makes us a reliable supplier and development partner.

Comprehensive services complete our offering: SICK LifeTime Services provide support throughout the machine life cycle and ensure safety and productivity.

For us, that is “Sensor Intelligence.”

WORLDWIDE PRESENCE:

Contacts and other locations –www.sick.com