

YF2A14-080VB3M2A14

Sensor/actuator cable

PLUG CONNECTORS AND CABLES

SICK
Sensor Intelligence.

YF2A14-080VB3M2A14 | Sensor/actuator cable

PLUG CONNECTORS AND CABLES



Ordering information

Type	Part no.
YF2A14-080VB3M2A14	2116008

Other models and accessories → www.sick.com/Sensor_actuator_cable



Detailed technical data

Technical specifications

Accessory group	Plug connectors and cables
Accessory family	Connection cables
Connection type head A	Female connector, M12, 4-pin, straight, A-coded
Connection type head B	Male connector, M12, 4-pin, straight, A-coded
Locking plug connector	Screw connection
Connector material	TPU
Connector color	Black
Locking nut material	Zinc die-cast, nickel-plated
Seal material	FKM
Tightening torque	0.6 Nm
Width across flats	13
Cable	8 m, 4-wire, PVC
Jacket material	PVC
Jacket color	Gray
Cable diameter	5 mm
Conductor cross section	0.34 mm ²
Shielding	Unshielded
Bending radius	
	Flexible use > 10 x cable diameter
	Stationary position > 5 x cable diameter
Reference voltage	≤ 250 V AC/DC
Rated impulse voltage	2.5 kV
Current loading	≤ 4 A
Signal type	Sensor/actuator cable
Application	Zones with chemicals
Authorizations	CE UL
UL File No.	E335179
Enclosure rating	IP65 / IP66K / IP67

Ambient operating temperature	Flexible use	-5 °C ... +80 °C
	Stationary position	-30 °C ... +80 °C
	Head	-25 °C ... +85 °C
Contamination rating		3
Insulation resistance		100 MΩ
Overvoltage category		III
Specific insulation resistance		30 mΩ
Thermal resistance, piping		Flame retardant according to UL 1581 VW1 / CSA FT1

Classifications

ECLASS 5.0	19030312
ECLASS 5.1.4	19030312
ECLASS 6.0	27060304
ECLASS 6.2	27060304
ECLASS 7.0	27060304
ECLASS 8.0	27060304
ECLASS 8.1	27060304
ECLASS 9.0	27060304
ECLASS 10.0	27060304
ECLASS 11.0	27060304
ECLASS 12.0	27060304
ETIM 5.0	EC000830
ETIM 6.0	EC000830
ETIM 7.0	EC003249
ETIM 8.0	EC003249
UNSPSC 16.0901	26121604

Dimensional drawing (Dimensions in mm (inch))

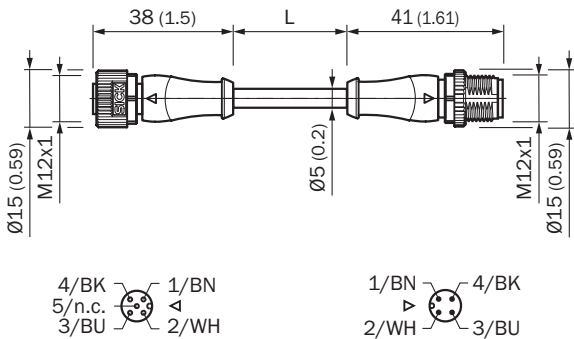

SICK AT A GLANCE

SICK is one of the leading manufacturers of intelligent sensors and sensor solutions for industrial applications. A unique range of products and services creates the perfect basis for controlling processes securely and efficiently, protecting individuals from accidents and preventing damage to the environment.

We have extensive experience in a wide range of industries and understand their processes and requirements. With intelligent sensors, we can deliver exactly what our customers need. In application centers in Europe, Asia and North America, system solutions are tested and optimized in accordance with customer specifications. All this makes us a reliable supplier and development partner.

Comprehensive services complete our offering: SICK LifeTime Services provide support throughout the machine life cycle and ensure safety and productivity.

For us, that is “Sensor Intelligence.”

WORLDWIDE PRESENCE:

Contacts and other locations –www.sick.com