



YG2A68-050XXXLECX

Sensor/actuator cable

PLUG CONNECTORS AND CABLES

SICK
Sensor Intelligence.



Illustration may differ

Ordering information

Type	Part no.
YG2A68-050XXXLECX	6061576

For 8-pin sensor-actuator cables, the wire colors are not standardized. Therefore, please observe the pin assignment of the sensor and the cable in the respective data sheet.

Other models and accessories → www.sick.com/Sensor_actuator_cable

Detailed technical data

Technical specifications

Accessory group	Plug connectors and cables
Accessory family	Connecting cables
Connection type head A	Female connector, M12, 8-pin, angled
Connection type head B	Flying leads
Locking plug connector	Quick screw connection
Cable	5 m, 8-wire, PUR, halogen-free
Jacket material	PUR, halogen-free
Cable diameter	Ø 7.7 mm
Conductor cross section	0.25 mm ²
Shielding	Shielded
Signal type	RS-422, SSI
Authorizations	UL
Enclosure rating	IP67
Specialty	Very good oil and chemical resistance

Classifications

ECLASS 5.0	19030312
ECLASS 5.1.4	19030312
ECLASS 6.0	27060304
ECLASS 6.2	27060304
ECLASS 7.0	27060304
ECLASS 8.0	27060304
ECLASS 8.1	27060304
ECLASS 9.0	27060304
ECLASS 10.0	27060304
ECLASS 11.0	27060304
ECLASS 12.0	27060304
ETIM 5.0	EC000830
ETIM 6.0	EC000830
ETIM 7.0	EC003249
ETIM 8.0	EC003249

UNSPSC 16.0901

26121604

Dimensional drawing (Dimensions in mm (inch))

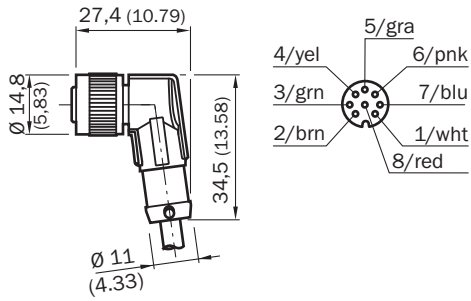

SICK AT A GLANCE

SICK is one of the leading manufacturers of intelligent sensors and sensor solutions for industrial applications. A unique range of products and services creates the perfect basis for controlling processes securely and efficiently, protecting individuals from accidents and preventing damage to the environment.

We have extensive experience in a wide range of industries and understand their processes and requirements. With intelligent sensors, we can deliver exactly what our customers need. In application centers in Europe, Asia and North America, system solutions are tested and optimized in accordance with customer specifications. All this makes us a reliable supplier and development partner.

Comprehensive services complete our offering: SICK LifeTime Services provide support throughout the machine life cycle and ensure safety and productivity.

For us, that is “Sensor Intelligence.”

WORLDWIDE PRESENCE:

Contacts and other locations –www.sick.com