

YM2D24-020EA1MRJA4

Industrial Ethernet cables and fieldbus cables

PLUG CONNECTORS AND CABLES

SICK
Sensor Intelligence.

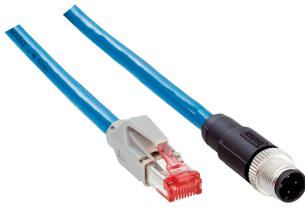

Ordering information

Type	Part no.
YM2D24-020EA1MRJA4	6034414

Other models and accessories → www.sick.com/Industrial_Ethernet_cables_and_fieldbus_cables

Detailed technical data

Technical specifications

Accessory group	Plug connectors and cables						
Accessory family	Connection cables						
Connection type head A	Male connector, M12, 4-pin, straight, D-coded						
Connection type head B	Male connector, RJ45, 8-pin, straight						
Tightening torque	0.4 Nm						
Cable	2 m, 4-wire, AWG26, PUR, halogen-free						
Jacket material	PUR, halogen-free						
Jacket color	Green						
Cable diameter	6.4 mm						
Conductor cross section	0.14 mm ²						
Shielding	Shielded						
Bending radius	<table border="0"> <tr> <td style="padding-right: 20px;">Flexible use</td> <td>> 8 x cable diameter</td> </tr> <tr> <td>Stationary position</td> <td>> 4 x cable diameter</td> </tr> </table>	Flexible use	> 8 x cable diameter	Stationary position	> 4 x cable diameter		
Flexible use	> 8 x cable diameter						
Stationary position	> 4 x cable diameter						
Reference voltage	≤ 60 V						
Current loading	4 A						
Signal type	Ethernet						
Transmission characteristics	CAT5						
Data transmission rate	≤ 100 Mbit/s						
Special feature	Twisted pair						
Enclosure rating	IP67 (M12), IP20 (RJ45) ¹⁾						
Ambient operating temperature	<table border="0"> <tr> <td style="padding-right: 20px;">Flexible use</td> <td>-20 °C ... +80 °C</td> </tr> <tr> <td>Stationary position</td> <td>-40 °C ... +80 °C</td> </tr> <tr> <td>Head</td> <td>-25 °C ... +90 °C</td> </tr> </table>	Flexible use	-20 °C ... +80 °C	Stationary position	-40 °C ... +80 °C	Head	-25 °C ... +90 °C
Flexible use	-20 °C ... +80 °C						
Stationary position	-40 °C ... +80 °C						
Head	-25 °C ... +90 °C						

¹⁾ M12.

Classifications

ECLASS 5.0	19030312
ECLASS 5.1.4	19030312
ECLASS 6.0	27060304

ECLASS 6.2	27060304
ECLASS 7.0	27060304
ECLASS 8.0	27060304
ECLASS 8.1	27060304
ECLASS 9.0	27060304
ECLASS 10.0	27060304
ECLASS 11.0	27060304
ECLASS 12.0	27060304
ETIM 5.0	EC000830
ETIM 6.0	EC000830
ETIM 7.0	EC003249
ETIM 8.0	EC003249
UNSPSC 16.0901	26121604

Dimensional drawing (Dimensions in mm (inch))

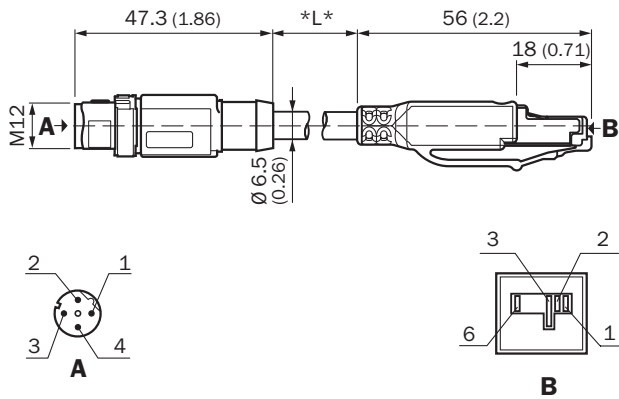

SICK AT A GLANCE

SICK is one of the leading manufacturers of intelligent sensors and sensor solutions for industrial applications. A unique range of products and services creates the perfect basis for controlling processes securely and efficiently, protecting individuals from accidents and preventing damage to the environment.

We have extensive experience in a wide range of industries and understand their processes and requirements. With intelligent sensors, we can deliver exactly what our customers need. In application centers in Europe, Asia and North America, system solutions are tested and optimized in accordance with customer specifications. All this makes us a reliable supplier and development partner.

Comprehensive services complete our offering: SICK LifeTime Services provide support throughout the machine life cycle and ensure safety and productivity.

For us, that is “Sensor Intelligence.”

WORLDWIDE PRESENCE:

Contacts and other locations –www.sick.com