





### Ordering information

Type	Part no.
IME2S12-04B4DC0	1091944

Other models and accessories → [www.sick.com/IME2S](http://www.sick.com/IME2S)



### Detailed technical data

#### Features

<b>Sensor principle</b>	Inductive
<b>Number of safe outputs</b>	2
<b>Housing diameter</b>	M12
<b>Sensing range <math>S_n</math></b>	4 mm <sup>1)</sup>
<b>Safe switch on distance <math>S_{ao}</math></b>	3.2 mm <sup>1)</sup>
<b>Safe switch off distance <math>S_{ar}</math></b>	6 mm <sup>1)</sup>
<b>Active sensor surfaces</b>	1
<b>Actuation frequency</b>	≤ 100 Hz
<b>Items supplied</b>	Including mounting nuts, brass, nickel-plated (2x)

<sup>1)</sup> Values apply for steel (FE360).

#### Safety-related parameters

<b>Safety integrity level</b>	SIL 2 (IEC 61508)
<b>Category</b>	Category 2 (ISO 13849-1)
<b>Performance level</b>	PL d (ISO 13849-1)
<b>PFH<sub>D</sub> (mean probability of a dangerous failure per hour)</b>	$6.0 \times 10^{-8}$ <sup>1)</sup>
<b>T<sub>M</sub> (mission time)</b>	20 years (ISO 13849-1)
<b>Type</b>	Type 3 (ISO 14119-1)
<b>Actuator coding level</b>	Uncoded (EN ISO 14119)
<b>Safe state in the event of a fault</b>	At least one safety-related semiconductor output (OSSD) is in the OFF state.

<sup>1)</sup> At 40 °C and 1000 m above sea level.

#### Functions

<b>Safe series connection</b>	With Flexi Loop (with diagnostics)
-------------------------------	------------------------------------

#### Interfaces

<b>Connection type</b>	Male connector M12, 4-pin
------------------------	---------------------------

Coupling nut material	Nickel-plated brass
<b>IO-Link Safety</b>	WCDT ≤ 1 ms
	OFDT ≤ 20 ms
<b>Display elements</b>	LEDs
	Diagnostics indicator ✓
Status display	✓

Electrical data

<b>Protection class</b>	III (IEC 61140)
<b>Rated insulation voltage <math>U_i</math></b>	28.8 V
<b>Rated impulse withstand voltage <math>U_{imp}</math></b>	1,500 V
<b>Supply voltage <math>V_s</math></b>	24 V DC (19.2 V DC ... 28.8 V DC)
<b>Power consumption</b>	≤ 20 mA
<b>Type of output</b>	Self-monitoring semiconductor outputs (OSSDs)
<b>Response time</b>	≤ 1 ms
<b>Release time</b>	≤ 1 ms
<b>Risk time</b>	≤ 20 ms
<b>Switch-on time</b>	≤ 1 s

Mechanical data

<b>Design</b>	Cylindrical
<b>Housing diameter</b>	M12
<b>Housing length</b>	65 mm
<b>Thread length</b>	40.9 mm
<b>Material</b>	Housing Nickel-plated brass
	Sensor surface VISTAL®
<b>Installation type</b>	Flush

Ambient data

<b>Enclosure rating</b>	IP67 (IEC 60529)
<b>Ambient operating temperature</b>	-25 °C ... +70 °C
<b>Storage temperature</b>	-25 °C ... +70 °C
<b>Relative humidity</b>	50 %, at 70 °C (IEC 60947-5-2)
<b>Vibration resistance</b>	10 Hz ... 55 Hz, 1 mm (IEC 60947-5-2)
<b>EMC</b>	IEC 60947-5-2, IEC 60947-5-3, IEC 61000-6-7

Classifications

<b>ECLASS 5.0</b>	27272401
<b>ECLASS 5.1.4</b>	27272401
<b>ECLASS 6.0</b>	27272401
<b>ECLASS 6.2</b>	27272401
<b>ECLASS 7.0</b>	27272401
<b>ECLASS 8.0</b>	27272401

<b>ECLASS 8.1</b>	27272401
<b>ECLASS 9.0</b>	27272401
<b>ECLASS 10.0</b>	27272401
<b>ECLASS 11.0</b>	27272401
<b>ECLASS 12.0</b>	27274101
<b>ETIM 5.0</b>	EC001818
<b>ETIM 6.0</b>	EC001818
<b>ETIM 7.0</b>	EC001818
<b>ETIM 8.0</b>	EC001818
<b>UNSPSC 16.0901</b>	39122205

### Dimensional drawing (Dimensions in mm (inch))

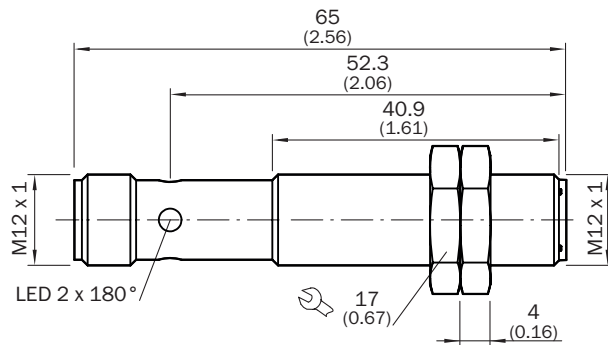

### Response range

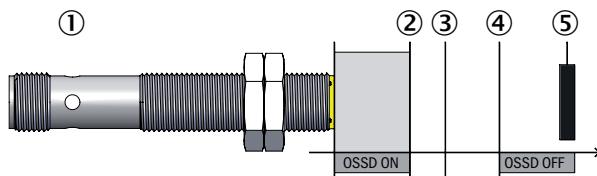

- ① Safety switch
- ② Safe switch on distance  $S_{ao}$
- ③ Sensing range  $S_n$
- ④ Safe switch off distance  $S_{ar}$
- ⑤ Actuator

### Pin assignment

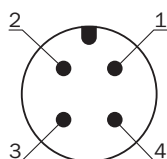





Pin	Designation	Description
1	+24 V DC	24 V DC voltage supply
2	OSSD 1	OSSD 1 output
3	0 V DC	0 V DC voltage supply
4	OSSD 2	OSSD 2 output

For details see operating instructions

## Recommended accessories

Other models and accessories → [www.sick.com/IME2S](http://www.sick.com/IME2S)

	Brief description	Type	Part no.
Mounting brackets and plates			
	Mounting bracket for M12 sensors, steel, zinc coated, without mounting hardware	BEF-WN-M12	5308447
Plug connectors and cables			
	<ul style="list-style-type: none"> <li>• <b>Connection type head A:</b> Female connector, M12, 4-pin, straight, A-coded</li> <li>• <b>Connection type head B:</b> Flying leads</li> <li>• <b>Signal type:</b> Sensor/actuator cable</li> <li>• <b>Cable:</b> 2 m, 4-wire, PVC</li> <li>• <b>Description:</b> Sensor/actuator cable, unshielded</li> <li>• <b>Application:</b> Zones with chemicals</li> </ul>	YF2A14-020VB3XLEAX	2096234
	<ul style="list-style-type: none"> <li>• <b>Connection type head A:</b> Female connector, M12, 4-pin, straight, A-coded</li> <li>• <b>Connection type head B:</b> Flying leads</li> <li>• <b>Signal type:</b> Sensor/actuator cable</li> <li>• <b>Cable:</b> 5 m, 4-wire, PVC</li> <li>• <b>Description:</b> Sensor/actuator cable, unshielded</li> <li>• <b>Application:</b> Zones with chemicals</li> </ul>	YF2A14-050VB3XLEAX	2096235
	<ul style="list-style-type: none"> <li>• <b>Connection type head A:</b> Female connector, M12, 4-pin, straight, A-coded</li> <li>• <b>Connection type head B:</b> Flying leads</li> <li>• <b>Signal type:</b> Sensor/actuator cable</li> <li>• <b>Cable:</b> 15 m, 4-wire, PVC</li> <li>• <b>Description:</b> Sensor/actuator cable, unshielded</li> <li>• <b>Application:</b> Zones with chemicals</li> </ul>	YF2A14-150VB3XLEAX	2096237
Terminal and alignment brackets			
	Clamping block for round sensors M12, without fixed stop, plastic (PA12), glass-fiber reinforced, mounting hardware included	BEF-KH-M12	2051479
Safety switching amplifier			
	<ul style="list-style-type: none"> <li>• <b>Applications:</b> Evaluation unit</li> <li>• <b>Compatible sensor types:</b> Safety sensors with OSSDs</li> <li>• <b>Connection type:</b> Front connector with spring terminals</li> <li>• <b>Restart interlock:</b> yes</li> <li>• <b>External device monitoring (EDM):</b> Integrated</li> <li>• <b>Outputs:</b> 2 enabling current paths (safe), 2 application diagnostic outputs (not safe), 1 test pulse output (not safe)</li> <li>• <b>Housing width:</b> 18 mm</li> </ul>	RLY3-OSSD200	1085344

## SICK AT A GLANCE

SICK is one of the leading manufacturers of intelligent sensors and sensor solutions for industrial applications. A unique range of products and services creates the perfect basis for controlling processes securely and efficiently, protecting individuals from accidents and preventing damage to the environment.

We have extensive experience in a wide range of industries and understand their processes and requirements. With intelligent sensors, we can deliver exactly what our customers need. In application centers in Europe, Asia and North America, system solutions are tested and optimized in accordance with customer specifications. All this makes us a reliable supplier and development partner.

Comprehensive services complete our offering: SICK LifeTime Services provide support throughout the machine life cycle and ensure safety and productivity.

For us, that is “Sensor Intelligence.”

## WORLDWIDE PRESENCE:

Contacts and other locations –[www.sick.com](http://www.sick.com)