



TiM150-3010300

TiM

2D LIDAR SENSORS

SICK
Sensor Intelligence.



Ordering information

Type	Part no.
TiM150-3010300	1093243

Other models and accessories → www.sick.com/TiM



Detailed technical data

Features

Measurement principle	HDDM ⁺
Application	Indoor
Light source	Infrared (850 nm)
Laser class	1 (IEC 60825-1:2014, EN 60825-1:2014)
Aperture angle	Horizontal 200°
Scanning frequency	14.5 Hz
Angular resolution	1°
Working range	0.05 m ... 10 m
Scanning range	At 10% remission factor 2.8 m ... 3 m, depending on the angle

Mechanics/electronics

Connection type	1 x 5-pin M12 male device connector (rotatable)
Supply voltage	10 V DC ... 28 V DC ¹⁾
Power consumption	Typ. 2.7 W
Output current	≤ 100 mA
Housing color	Light blue (RAL 5012)
Enclosure rating	IP65 (IEC 60529:1989+AMD1:1999+AMD2:2013)
Protection class	III (IEC 61140:2016-1)
Weight	122 g, without connecting cables
Dimensions (L x W x H)	60 mm x 60 mm x 75.8 mm

¹⁾ When using IO-Link output $V_S > 18$ V.

MTBF	82 years
-------------	----------

¹⁾ When using IO-Link output $V_S > 18\text{ V}$.

Safety-related parameters

MTTF_D	> 100 years
-------------------------	-------------

Performance

Response time	Typ. 70 ms
Detectable object shape	Almost any
Systematic error	$\pm 40\text{ mm}^{\text{1)}$
Statistical error	$30\text{ mm}^{\text{1)}$
Integrated application	Field evaluation
Number of field sets	1 field set
Simultaneous evaluation cases	1 (2 fields)

¹⁾ Typical value; actual value depends on environmental conditions.

Interfaces

IO-Link	✓
Function	Service interface, parameterization
Digital inputs	1
Digital outputs	2 (Push-pull)
Delay time	69 ms ... 30,015 ms (configurable)
Dwell time	69 ms ... 30,015 ms (configurable)
Optical indicators	2 LEDs (ON, switching status)

Ambient data

Object remission	4 % ... 1,000 % (reflectors)
Electromagnetic compatibility (EMC)	IEC 61000-6-3:2006+AMD1:2010 / IEC 61000-6-2:2005
Vibration resistance	
Sine resonance scan	10 Hz ... 1,000 Hz ¹⁾
Sine test	10 Hz ... 150 Hz, 1 g, 1 frequency cycles ¹⁾
Noise test	10 Hz ... 200 Hz, 5 g RMS, 2 h ²⁾
Ambient operating temperature	-10 °C ... +50 °C
Storage temperature	-30 °C ... +70 °C
Permissible relative humidity	$\leq 95\%$, Non-condensing ³⁾
Ambient light immunity	30,000 lx

¹⁾ IEC 60068-2-6:2007.

²⁾ IEC 60068-2-64:2008.

³⁾ EN 60068-2-30:2005.

General notes

Note on use	The sensor does not constitute a safety component as defined by relevant legislation on machine safety.
--------------------	---

Classifications

ECLASS 5.0	27270990
-------------------	----------

ECLASS 5.1.4	27270990
ECLASS 6.0	27270913
ECLASS 6.2	27270913
ECLASS 7.0	27270913
ECLASS 8.0	27270913
ECLASS 8.1	27270913
ECLASS 9.0	27270913
ECLASS 10.0	27270913
ECLASS 11.0	27270913
ECLASS 12.0	27270913
ETIM 5.0	EC002550
ETIM 6.0	EC002550
ETIM 7.0	EC002550
ETIM 8.0	EC002550
UNSPSC 16.0901	41111615

Dimensional drawing (Dimensions in mm (inch))

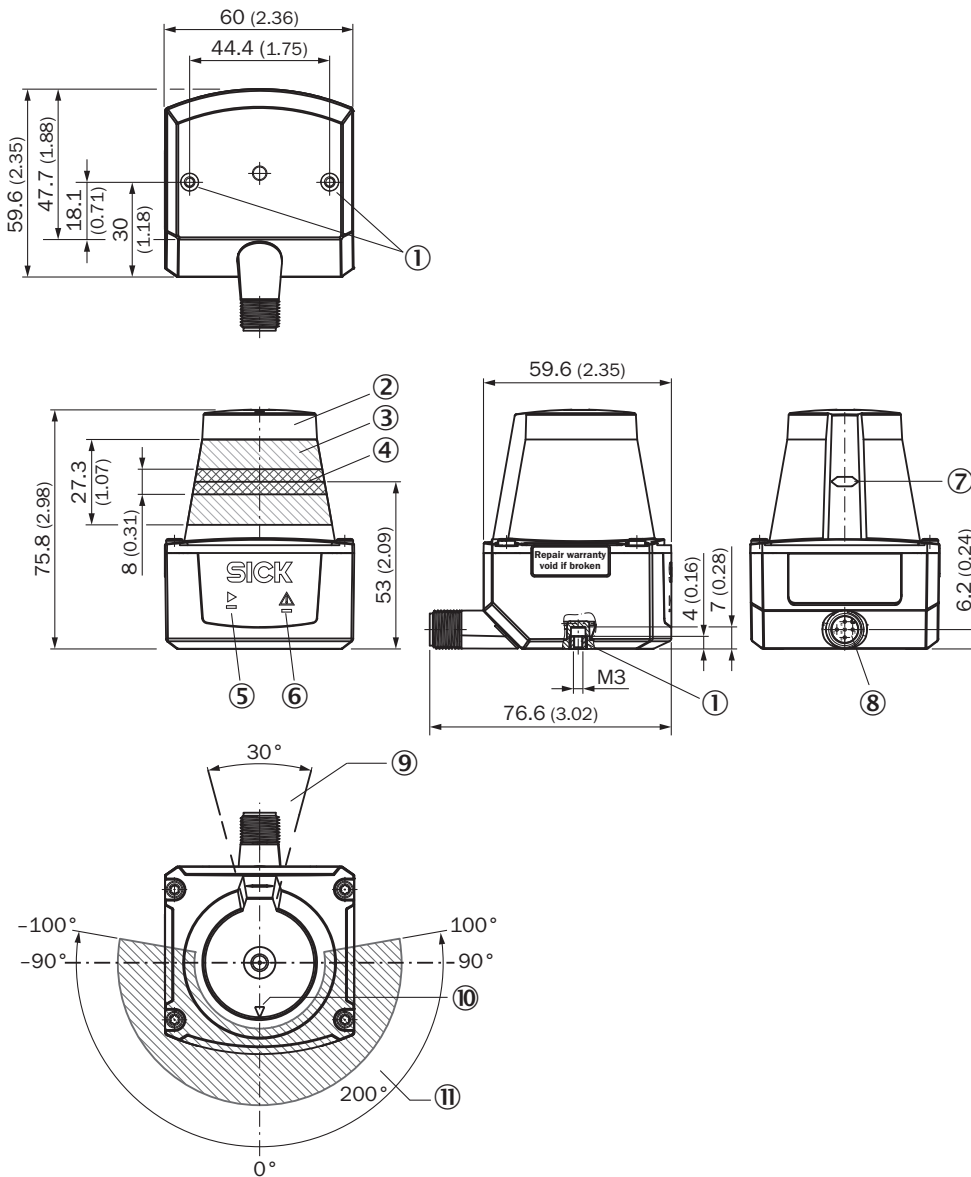

- ① M3 threaded mounting hole, 2.8 mm deep (blind hole thread), max. tightening torque 0.7 Nm
- ② Optical hood
- ③ Receiving range (light inlet)
- ④ Transmission range (light emission)
- ⑤ Green LED
- ⑥ Red LED
- ⑦ Marking for the position of the light emission level
- ⑧ 5-pin M12 male connector (rotatable)
- ⑨ Area in which no reflective surfaces are allowed for mounted devices
- ⑩ Bearing marking to support alignment (0° axis)
- ⑪ Aperture angle 200° (scanning angle)

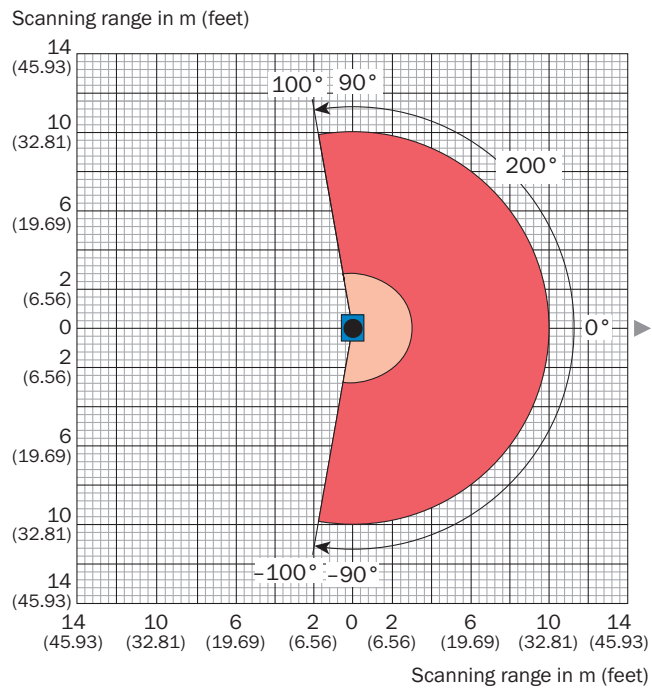

Working range diagram





- Scanning range max. 10 m (32.81 ft)
- Scanning range 2.8 m to 3 m (9.19 ft to 9.84 ft) for objects with 10 % remission, dependent on the angle

Recommended accessories

Other models and accessories → www.sick.com/TiM

	Brief description	Type	Part no.
Connection modules			
	IO-Link V1.1 Class A port, USB2.0 port, optional external power supply 24V / 1A	IOLA2US-01101 (SiLink2 Master)	1061790
Mounting brackets and plates			
	Mounting kit	Mounting kit	2082188
	Q-lock mounting system	Q-Lock mounting kit	2083311

	Brief description	Type	Part no.
Plug connectors and cables			
	<ul style="list-style-type: none"> • Connection type head A: Female connector, M12, 5-pin, straight, A-coded • Connection type head B: Flying leads • Signal type: Sensor/actuator cable • Cable: 2 m, 5-wire, PUR, halogen-free • Description: Sensor/actuator cable, unshielded • Application: Zones with oils and lubricants, Drag chain operation, Robot 	YF2A15-020UB5XLEAX	2095617
	<ul style="list-style-type: none"> • Connection type head A: Female connector, M12, 5-pin, straight, A-coded • Connection type head B: Male connector, M12, 5-pin, straight, A-coded • Signal type: Sensor/actuator cable • Cable: 2 m, 5-wire, PUR, halogen-free • Description: Sensor/actuator cable, unshielded • Application: Zones with oils and lubricants, Drag chain operation, Robot 	YF2A15-020UB5M2A15	2096009

Recommended services

Additional services → www.sick.com/TiM

	Type	Part no.
Maintenance		
<ul style="list-style-type: none"> • Product area: 2D LiDAR sensors, 3D LiDAR sensors • Range of services: Inspection, analysis and restoring of defined functions, Inspection and adaptation of basic settings, parameters of field application, filters for raw data output, and product-specific configuration • Duration: Additional work will be invoiced separately • Travel expenses: The prices do not include travel costs such as hotel, flight, travel time and expenses. 	Maintenance of LiDAR sensors	1682593
Commissioning		
<ul style="list-style-type: none"> • Product area: 2D LiDAR sensors, 3D LiDAR sensors • Range of services: Inspection of connection, fine adjustment, configuration of monitored areas, configuration and optimization of parameters as well as tests, Setup of previously defined functions of basic settings, parameters of field application, filters for raw data output and product-specific configuration • Travel expenses: The prices do not include travel costs such as hotel, flight, travel time and expenses. • Duration: Additional work will be invoiced separately 	Commissioning LiDAR sensors	1680672
Extended warranty		
<ul style="list-style-type: none"> • Product area: Identification solutions, machine vision, Detection and ranging solutions, safety camera sensors, Safety laser scanners, Safety radar sensors • Range of services: The services correspond to the scope of the statutory manufacturer warranty (SICK general terms of delivery). • Duration: Five-year warranty from delivery date. 	Extended warranty for a total of five years from delivery date	1680671

SICK AT A GLANCE

SICK is one of the leading manufacturers of intelligent sensors and sensor solutions for industrial applications. A unique range of products and services creates the perfect basis for controlling processes securely and efficiently, protecting individuals from accidents and preventing damage to the environment.

We have extensive experience in a wide range of industries and understand their processes and requirements. With intelligent sensors, we can deliver exactly what our customers need. In application centers in Europe, Asia and North America, system solutions are tested and optimized in accordance with customer specifications. All this makes us a reliable supplier and development partner.

Comprehensive services complete our offering: SICK LifeTime Services provide support throughout the machine life cycle and ensure safety and productivity.

For us, that is “Sensor Intelligence.”

WORLDWIDE PRESENCE:

Contacts and other locations –www.sick.com