

BEF-WN-M08

**SICK**  
Sensor Intelligence.



## Ordering information

Type	Part no.
BEF-WN-M08	5321721

Other models and accessories → [www.sick.com/](http://www.sick.com/)

## Detailed technical data

### Technical specifications

<b>Accessory group</b>	Mounting brackets and plates
<b>Accessory family</b>	Mounting brackets
<b>Material</b>	Steel, zinc coated
<b>Items supplied</b>	Without mounting hardware
<b>Description</b>	Mounting bracket for M8 sensors

### Classifications

<b>eCl@ss 5.0</b>	27279202
<b>eCl@ss 5.1.4</b>	27279202
<b>eCl@ss 6.0</b>	27279202
<b>eCl@ss 6.2</b>	27279202
<b>eCl@ss 7.0</b>	27279202
<b>eCl@ss 8.0</b>	27279202
<b>eCl@ss 8.1</b>	27279202
<b>eCl@ss 9.0</b>	27273701
<b>eCl@ss 10.0</b>	27273701
<b>eCl@ss 11.0</b>	27273701
<b>eCl@ss 12.0</b>	27273701
<b>ETIM 5.0</b>	EC002615
<b>ETIM 6.0</b>	EC002615
<b>ETIM 7.0</b>	EC002615
<b>ETIM 8.0</b>	EC002615
<b>UNSPSC 16.0901</b>	32131023

Dimensional drawing (Dimensions in mm (inch))

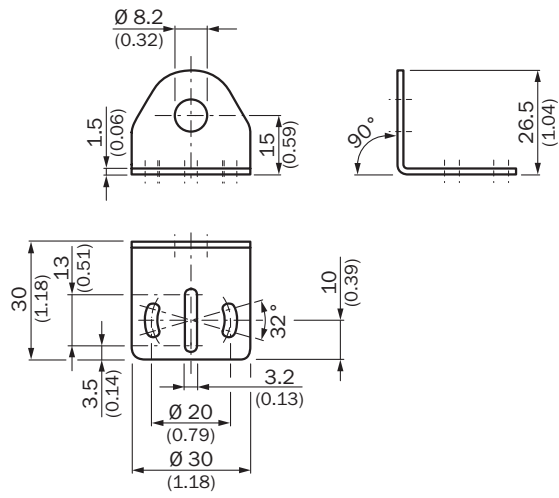

## SICK AT A GLANCE

SICK is one of the leading manufacturers of intelligent sensors and sensor solutions for industrial applications. A unique range of products and services creates the perfect basis for controlling processes securely and efficiently, protecting individuals from accidents and preventing damage to the environment.

We have extensive experience in a wide range of industries and understand their processes and requirements. With intelligent sensors, we can deliver exactly what our customers need. In application centers in Europe, Asia and North America, system solutions are tested and optimized in accordance with customer specifications. All this makes us a reliable supplier and development partner.

Comprehensive services complete our offering: SICK LifeTime Services provide support throughout the machine life cycle and ensure safety and productivity.

For us, that is “Sensor Intelligence.”

## WORLDWIDE PRESENCE:

Contacts and other locations –[www.sick.com](http://www.sick.com)