

S4B Safety Light Curtains

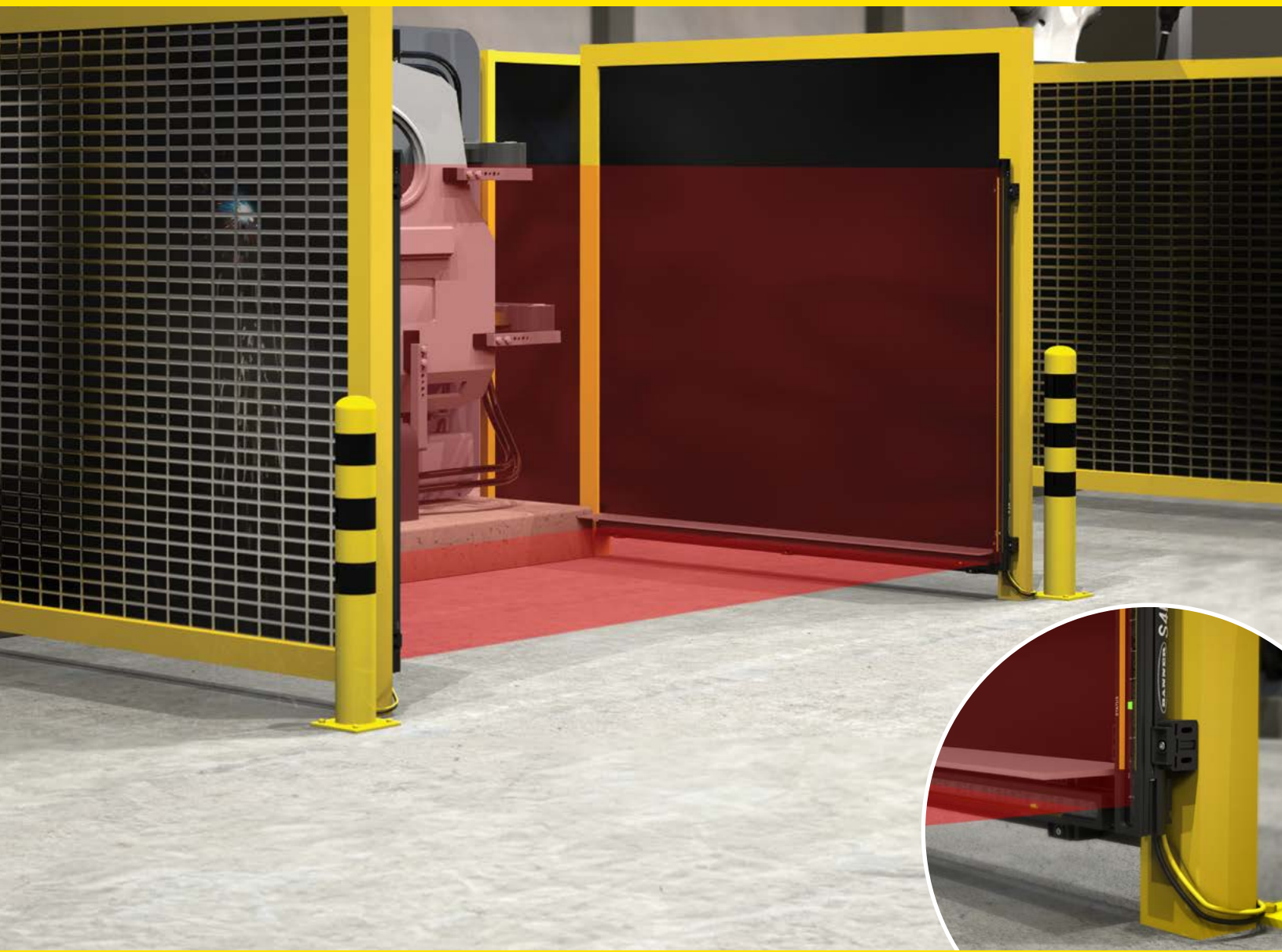

Simple Setup with Two Resolution Options for Optimal Personnel Protection

- Optimized auto cascade saves installation and setup time
- Specially designed cordsets simplify installation and maintenance
- 14- and 30-millimeter resolution options offer safety protection for different applications
- Zone indication and weak beam strength indicators reduce commissioning time and help identify maintenance needs
- Muting accessories refine system design and installation
- Endcap mounting and center mount brackets enable greater installation flexibility

BANNER[®]
more sensors, more solutions

Heavy-Duty Type 4 Light Curtains

Simple installation

The S4B gives you more flexibility when deciding how to mount light curtains on your machine. Choose from either center-mount brackets or end cap brackets, both offering up to 15 degrees of freedom to align the emitter and receiver. Once the light curtains are mounted, alignment is further simplified with the onboard alignment zone indicators as shown below.



Alignment Zone Indicators

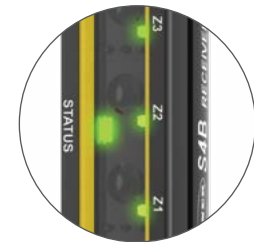
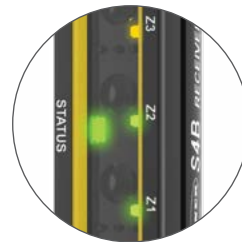
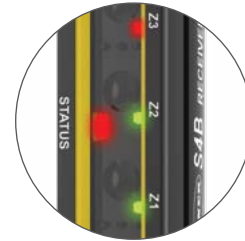



Predict and Prevent Downtime

Don't let a challenging environment with dust or dirt stop your machine from operating. The S4B detects when the beam strength is low and will send this signal via pin 5 on the connector to your PLC or HMI to notify maintenance teams that the lens needs to be cleaned.

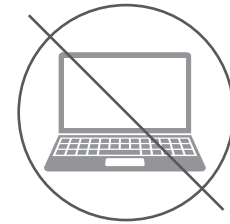

Intuitive Setup and Swap-out

Select and save scan code setting without a PC for easy setup and swap-out



Reliable Finger Detection
The S4B is available with 14-millimeter resolution for reliable finger detection

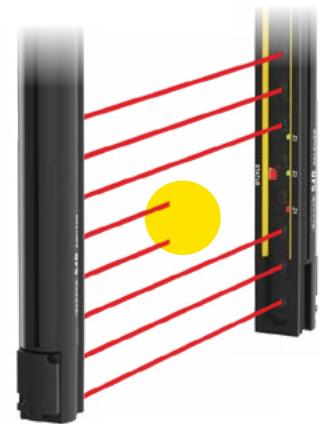

Reliable Hand Detection
The S4B is available with 30-millimeter resolution for reliable hand detection

Cascading and Muting Options

Save Installation and Setup Time with Auto Cascading

Auto cascading in the S4B speeds setup and installation, automatically recognizing the next light curtain as it is connected. The minimal response time impact when cascaded allows the S4B to be installed closer to the equipment being guarded, making more efficient use of valuable floor space.

Simplify Installation and Maintenance with Specially Designed Cordsets

Cordsets determine if the light curtain is used as a standalone pair or as part of a cascade. Specific connection genders and color-coded cordsets simplify and error-proof installation, using yellow for connecting multiple light curtain sticks while black runs back to the controller. Up to four pairs can be connected, including pairs of different resolutions or lengths.

Cascading Four Pairs

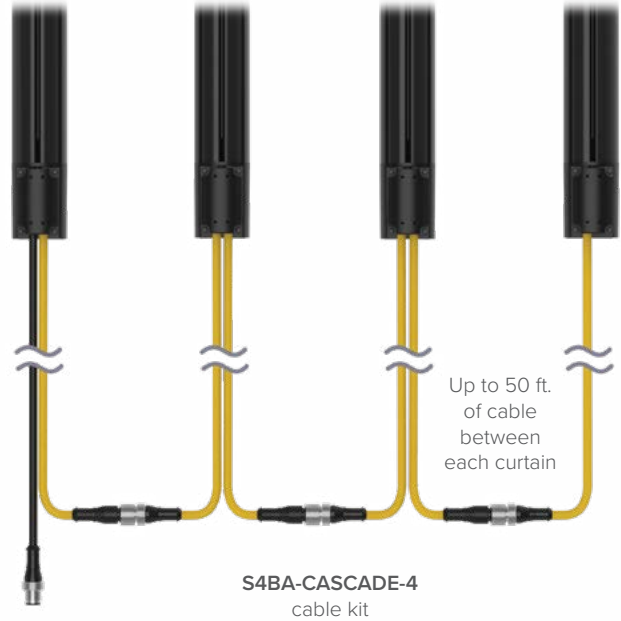

Up to 30 m cable length to controller, depending on current load and devices

Cascading Three Pairs

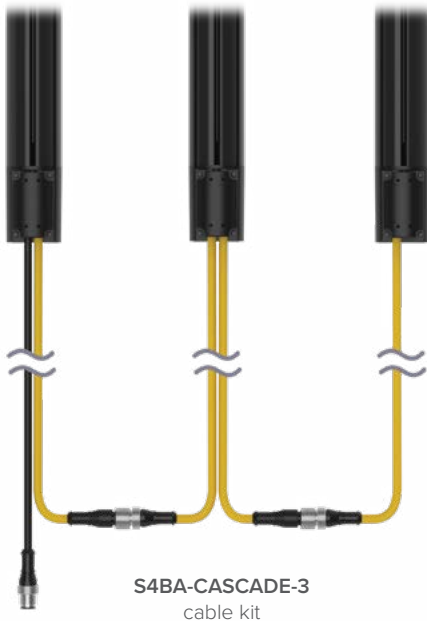

Cascading Two Pairs

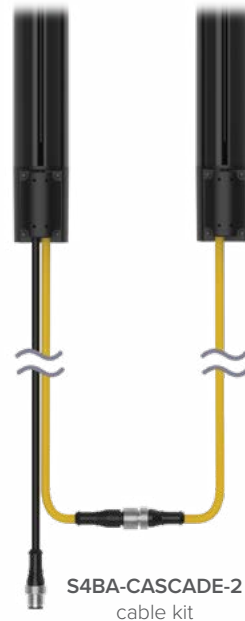

Refine System Design and Installation with Muting Accessories

Muting allows objects to pass through operational light curtains by temporarily suspending their safety function, then resuming after the object has passed through the light curtain's beams. Mute arms protect sensors from damage and misalignment. Flexible mounting options for photoelectric sensors accommodate a wide range of object sizes passing through. The muting block consolidates wiring by combining the S4B light curtains and non-safety sensors into one block.

Mute Arm Kit	Box or Pallet Muting		
	Enter/Exit Direction	Width & Shape	Position on Conveyor
L-Configuration	One-way (exit)	Varying	Varying
X-Configuration	Bi-Directional	Consistent	Consistent
T-Configuration	Bi-Directional	Varying	Varying

L-Configuration

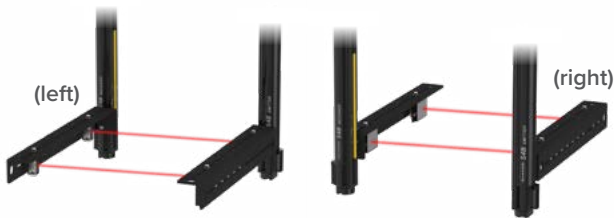

S4BA-ML-LPQ20

Includes: 2 mute arms, 2 Q20PLPQ5 sensors, and 2 retroreflectors

T-Configuration

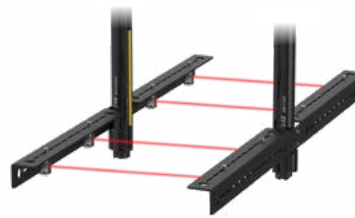

S4BA-MT-LPQ20

Includes: 2 mute arms, 4 Q20PLPQ5 sensors, and 4 retroreflectors

X-Configuration



S4BA-MX-LPQ20

Includes: 2 mute arms, 2 Q20PLPQ5 sensors, and 2 retroreflectors



S4B Safety Light Curtain - Build Your Bundle

Step 1A and 1B: Select your emitter and receiver _____

Length	14 mm Emitter	14 mm Receiver	30 mm Emitter	30 mm Receiver
300 mm	S4BE14-300-S	S4BR14-300-S	S4BE30-300-S	S4BR30-300-S
450 mm	S4BE14-450-S	S4BR14-450-S	S4BE30-450-S	S4BR30-450-S
600 mm	S4BE14-600-S	S4BR14-600-S	S4BE30-600-S	S4BR30-600-S
750 mm	S4BE14-750-S	S4BR14-750-S	S4BE30-750-S	S4BR30-750-S
900 mm	S4BE14-900-S	S4BR14-900-S	S4BE30-900-S	S4BR30-900-S
1050 mm	S4BE14-1050-S	S4BR14-1050-S	S4BE30-1050-S	S4BR30-1050-S
1200 mm	S4BE14-1200-S	S4BR14-1200-S	S4BE30-1200-S	S4BR30-1200-S
1350 mm	–	–	S4BE30-1350-S	S4BR30-1350-S
1500 mm	–	–	S4BE30-1500-S	S4BR30-1500-S
1650 mm	–	–	S4BE30-1650-S	S4BR30-1650-S
1800 mm	–	–	S4BE30-1800-S	S4BR30-1800-S

Note: One emitter and one receiver of the same length and resolution is required per system.

Step 2: Select your brackets _____

Description	Models
Side mount brackets with 15° of rotation (includes two brackets). Maximum of 900 mm of length between brackets.	S4BA-MBK-16
End cap mounting bracket with 15° rotation (includes two brackets and adapters). For lengths 1050 mm and longer.	S4BA-MBK-11

Note: Minimum of two per light curtain.

Step 3A or 3B: Select your S4B connection cables _____

3A: Standalone Pair	Models
5-Pin male cable standalone	DES4-M51-D
8-Pin male cable standalone for EDM	DES4-M81-D

Note: One required for each emitter and receiver.

3B: Cascade	Models
Cable kit for 2 S4B pairs Includes: 2-host cordsets, 5-pin to safety side, and 2-terminal cordsets	S4BA-CASCADE-2
Cable kit for 3 S4B pairs Includes: 2-host cordsets, 5-pin to safety side, 2-guest cordsets, and 2-terminal cordsets	S4BA-CASCADE-3
Cable kit for 4 S4B pairs Includes: 2-host cordsets, 5-pin to safety side, 4-guest cordsets, and 2-terminal cordsets	S4BA-CASCADE-4

Note: 8-Pin cascade cordset kits are also available. Check website for information.

Step 4: Select your extension cables (optional)

Length	5-Pin M12 Double-Ended (Yellow)	5-Pin M12 Double-Ended	5-Pin M12 with Flying Leads
0.3 m	DEE2R-51D	MQDEC-501SS	–
1.0 m	DEE2R-53D	MQDEC-503SS	–
5.0 m	DEE2R-515D	–	MQDC1-515
7.6 m	DEE2R-525D	MQDEC-525SS	–
9 m	–	–	MQDC1-530
18 m	–	–	MQDC1-560

Note: Sold individually.

Step 5: Add your y-splitter (optional)

Description	Models
5-Pin male M12 to dual 5-pin female M12 splitter	CSB-M1251M1251B

Note: Using a splitter helps reduce wiring (see graphic below).

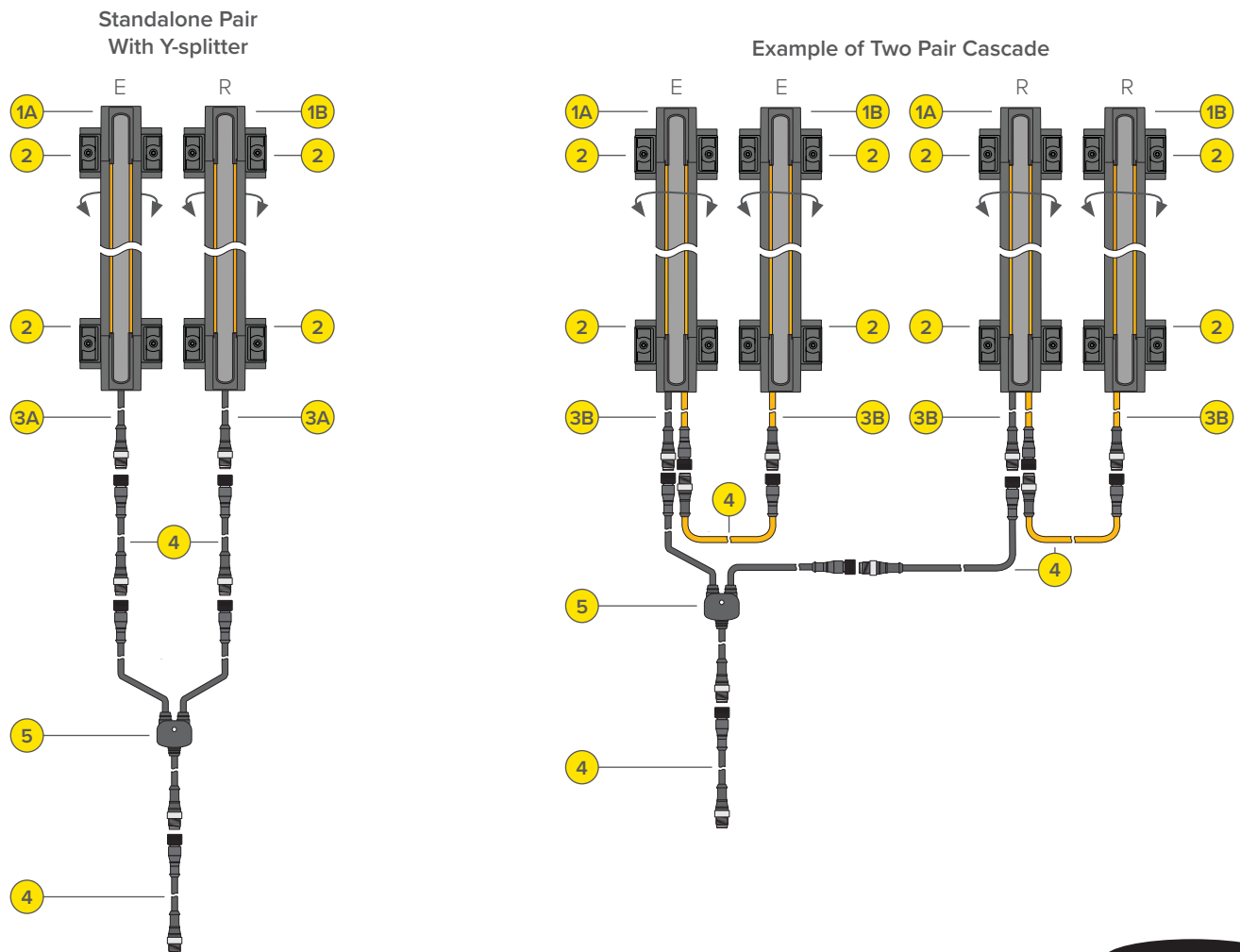

S4B Series Safety Light Curtains

Series	Device Type	Resolution	Defined Area		Termination	
S4B	E	30	—	900	—	S
E = Emitter only R = Receiver only		14 = 14 mm 30 = 30 mm	300 = 300 mm 450 = 450 mm 600 = 600 mm 750 = 750 mm 900 = 900 mm 1050 = 1050 mm	1200 = 1200 mm 1350 = 1350 mm* 1500 = 1500 mm* 1650 = 1650 mm* 1800 = 1800 mm*	S = Single Emitter or Receiver (S4B Bracket(s) and S4B Cordset(s) sold separately)	

*Only available in 30 mm resolution

Note: S4B brackets and S4B cordset are required for both emitter and receiver. Sold separately (see back page).

Specifications

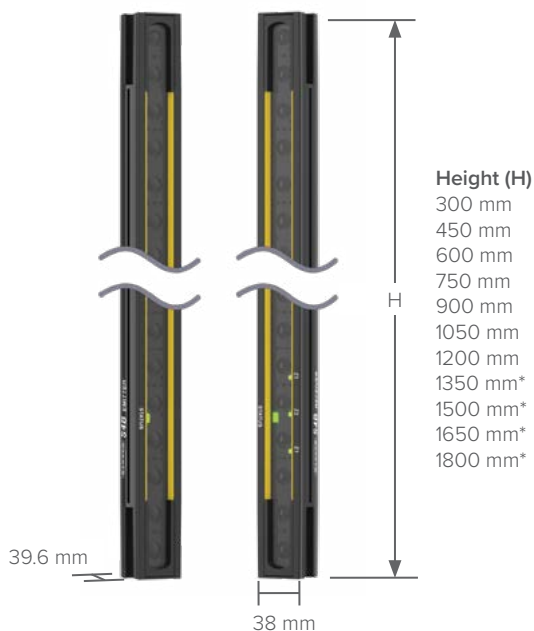

*Only available in 30 mm resolution

Supply Voltage	24 V DC ±15%
Resolution	14 or 30 mm
Output	Two 500 mA current sourcing (PNP) solid-state outputs (OSSD)
Operating Range	0.1 to 12 m
Selectable Scan Codes	Two user-selectable scan codes to avoid crosstalk among S4B pairs in close proximity
Construction	Robust aluminium housing with recessed window and die-cast end caps
Operating Conditions	-20 to +55 °C 95% maximum relative humidity (non-condensing)
Short Circuit Protection	All inputs and outputs are protected from short circuits to +24 V DC or DC common
Electrical Safety	Class III (per IEC 61140)
Safety Rating	Type 4 per IEC 61496-1, -2 Category 4 PL e per EN ISO13849-1 SIL3 per IEC 61508
Environmental Rating	IP65
Certifications	CE, UL LISTED

Accessories



Banner Engineering Corp.

9714 10th Avenue North • Minneapolis, MN 55441 • 1-888-373-6767 • www.bannerengineering.com