



# i15-MP0123 Lock

i15 Lock

SAFETY LOCKING DEVICES

**SICK**  
Sensor Intelligence.



### Ordering information

Type	Part no.
i15-MP0123 Lock	6034026

The actuator has to be ordered separately. See "Accessories" for further details.

Other models and accessories → [www.sick.com/i15\\_Lock](http://www.sick.com/i15_Lock)

actuator not supplied with delivery



### Detailed technical data

#### Features

<b>Sensor principle</b>	Electro-mechanical
<b>Locking principle</b>	Power to release
<b>Number of positive action N/C solenoid monitoring contacts</b>	1
<b>Number of N/O solenoid monitoring contacts</b>	0
<b>Number of positive action N/C door monitoring contacts</b>	2
<b>Number of N/O door monitoring contacts</b>	0
<b>Number of N/C door monitoring contacts</b>	0
<b>Locking force <math>F_{max}</math></b>	1,000 N (EN ISO 14119)
<b>Locking force <math>F_{Zh}</math></b>	700 N (EN ISO 14119)
<b>Actuation force</b>	≥ 35 N
<b>Retaining force</b>	≤ 30 N
<b>Actuation frequency</b>	≤ 7,000 /h
<b>Actuation directions</b>	4
<b>Approach speed</b>	≤ 20 m/min

#### Safety-related parameters

<b><math>B_{10d}</math> parameter</b>	$2 \times 10^6$ switching cycles (with small load)
<b>Type</b>	Type 2 (EN ISO 14119)
<b>Actuator coding level</b>	Low coding level (EN ISO 14119)
<b>Safe state in the event of a fault</b>	The switch has no internal fault detection and is unable to assume a safe state in the event of a fault. Fault detection is performed by the connected safety-related logic unit.

#### Functions

<b>Safe series connection</b>	None, only individual wiring (with diagnostics)
-------------------------------	---

## Interfaces

<b>Connection type</b>	Cable gland, 1 x M20
Conductor cross section	0.34 mm <sup>2</sup> ... 1.5 mm <sup>2</sup>

## Electrical data

<b>Contamination rating</b>	3
<b>Switching principle</b>	Slow action switching element
<b>Usage category</b>	AC-15/DC-13 (IEC 60947-5-1)
<b>Rated operating current (voltage)</b>	4 A (230 V AC) 4 A (24 V DC)
<b>Rated insulation voltage U<sub>i</sub></b>	250 V
<b>Rated impulse withstand voltage U<sub>imp</sub></b>	2,500 V
<b>Type of output</b>	Electro-mechanical contacts
<b>Power consumption</b>	≤ 6 W
<b>Short-circuit protection</b>	4 A gG
<b>Switching voltage</b>	≥ 12 V DC
<b>Switching current (switching voltage)</b>	≥ 1 mA (24 V DC)
<b>Solenoid operating voltage</b>	(20.4 V DC ... 26.4 V DC)
<b>Switch-on time of magnet</b>	100 %
<b>Locking principle</b>	Power to release

## Mechanical data

<b>Weight</b>	0.45 kg
<b>Housing material</b>	Glass-fiber reinforced thermoplastic
<b>Actuator head material</b>	Plastic
<b>Mechanical life</b>	2 x 10 <sup>6</sup> switching cycles

## Ambient data

<b>Enclosure rating</b>	IP67
<b>Ambient operating temperature</b>	-20 °C ... +55 °C
<b>Storage temperature</b>	-20 °C ... +55 °C

## Classifications

<b>ECLASS 5.0</b>	27272603
<b>ECLASS 5.1.4</b>	27272603
<b>ECLASS 6.0</b>	27272603
<b>ECLASS 6.2</b>	27272603
<b>ECLASS 7.0</b>	27272603
<b>ECLASS 8.0</b>	27272603
<b>ECLASS 8.1</b>	27272603
<b>ECLASS 9.0</b>	27272603
<b>ECLASS 10.0</b>	27272603
<b>ECLASS 11.0</b>	27272603
<b>ECLASS 12.0</b>	27272603
<b>ETIM 5.0</b>	EC002593

<b>ETIM 6.0</b>	EC002593
<b>ETIM 7.0</b>	EC002593
<b>ETIM 8.0</b>	EC002593
<b>UNSPSC 16.0901</b>	39122205

### Dimensional drawing (Dimensions in mm (inch))

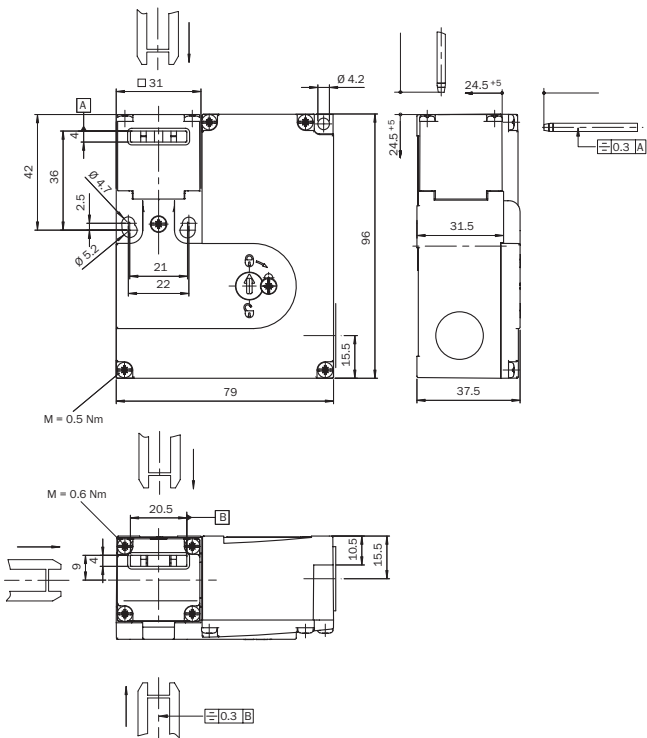

## Switching elements

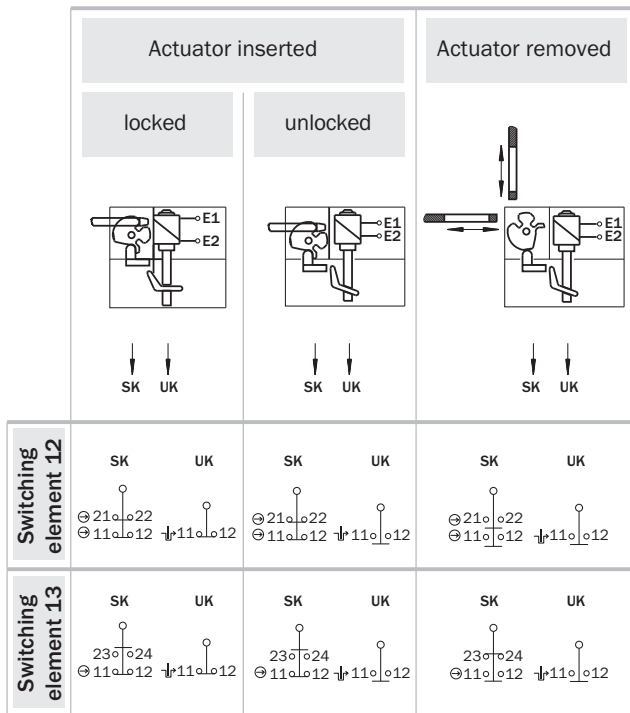

⇩ Positive action N/C locking monitoring contact

⊖ Positive action N/C door monitoring contact

**UK: Locking monitoring contacts**

**SK: Door monitoring contacts**

**Switching element 12:**

- 1 positive action N/C contact (Locking monitoring)
- 2 positive action N/C contacts (Door monitoring)

**Switching element 13:**

- 1 positive action N/C contact (Locking monitoring)
- 1 positive action N/C contact + 1 N/O contact (Door monitoring)

## SICK AT A GLANCE

SICK is one of the leading manufacturers of intelligent sensors and sensor solutions for industrial applications. A unique range of products and services creates the perfect basis for controlling processes securely and efficiently, protecting individuals from accidents and preventing damage to the environment.

We have extensive experience in a wide range of industries and understand their processes and requirements. With intelligent sensors, we can deliver exactly what our customers need. In application centers in Europe, Asia and North America, system solutions are tested and optimized in accordance with customer specifications. All this makes us a reliable supplier and development partner.

Comprehensive services complete our offering: SICK LifeTime Services provide support throughout the machine life cycle and ensure safety and productivity.

For us, that is “Sensor Intelligence.”

## WORLDWIDE PRESENCE:

Contacts and other locations –[www.sick.com](http://www.sick.com)