



TR110-SLU2B00

TR110 Lock

SAFETY LOCKING DEVICES

SICK
Sensor Intelligence.



Ordering information

Type	Part no.
TR110-SLU2B00	6068077

The actuator has to be ordered separately. See "Accessories" for further details.

Other models and accessories → www.sick.com/TR110_Lock



Detailed technical data

Features

Sensor principle	RFID
Locking principle	Power to lock
Coding	Uniquely coded
Locking force F_{max}	<ul style="list-style-type: none"> With straight actuator 3,900 N (EN ISO 14119) With angled actuator 1,500 N (EN ISO 14119) With hinged actuator 2,600 N (EN ISO 14119)
Locking force F_{Zh}	<ul style="list-style-type: none"> With straight actuator 3,000 N (EN ISO 14119) With angled actuator 1,100 N (EN ISO 14119) With hinged actuator 2,000 N (EN ISO 14119)
Actuation force	≥ 10 N
Retaining force	20 N
Force against which unlocking is possible	≤ 20 N
Actuation frequency	≤ 0.5 Hz
Approach speed	≤ 20 m/min
Pushbuttons (illuminable)	✓
Items supplied	Including 6 cover caps (blue, red, yellow, green, 2 x white)

Safety-related parameters

Safety integrity level	SIL 3 (IEC 61508)
Category	Category 4 (EN ISO 13849) ¹⁾
Performance level	PL e (EN ISO 13849) ¹⁾

¹⁾ Applies for monitoring of the door position (interlocking monitoring) and locking monitoring.

PFH_D (mean probability of a dangerous failure per hour)	4.1 x 10 ⁻⁹ ¹⁾
T_M (mission time)	20 years (EN ISO 13849)
Type	Type 4 (EN ISO 14119)
Actuator coding level	High coding level (EN ISO 14119)
Safe state in the event of a fault	At least one safety-related semiconductor output (OSSD) is in the OFF state.

¹⁾ Applies for monitoring of the door position (interlocking monitoring) and locking monitoring.

Functions

Switching behavior of the OSSDs	Locking monitoring
Safe series connection	None, only individual wiring (with diagnostics)

Interfaces

Connection type	Plug connector, M12, 8-pin Plug connector, M12, 5-pin
Coupling nut material	Brass
Pushbuttons (illuminable)	✓
Display elements	LEDs
Diagnostics indicator	✓
Status display	✓

Electrical data

Protection class	III (IEC 61140)
Contamination rating	3 (EN 60947-1)
Classification according to cULus	Class 2
Usage category	DC-13 (IEC 60947-5-1)
Rated operating current (voltage)	150 mA (24 V DC) ¹⁾
Rated insulation voltage U_i	50 V
Rated impulse withstand voltage U_{imp}	500 V
Supply voltage V_s	Sensor 24 V DC (20.4 V DC ... 27.6 V DC) Magnet 24 V DC (20.4 V DC ... 26.4 V DC)
Power consumption	Sensor 40 mA Magnet 400 mA Pushbutton (LED) 10 mA
Type of output	Self-monitoring semiconductor outputs (OSSDs) Safety outputs 2 semiconductor outputs (OSSDs), p-switching, short-circuit protected Application diagnostic outputs P-switching, short-circuit protected
Output current	Safety outputs 1 mA ... 150 mA Application diagnostic outputs 1 mA ... 50 mA Pushbutton switching outputs 1 mA ... 50 mA

¹⁾ In the case of inductive loads, outputs must be protected with a freewheeling diode.

²⁾ 5 ms for each additional switch.

Power consumption of magnet	6 W
Switch-on time of magnet	100 %
Response time	≤ 260 ms ²⁾
Release time	400 ms
Switch-on time	1 s
Discrepancy time	≤ 10 ms (EN IEC 60947-5-3)
Locking principle	Power to lock

¹⁾ In the case of inductive loads, outputs must be protected with a freewheeling diode.

²⁾ 5 ms for each additional switch.

Mechanical data

Weight	0.42 kg
Material	
Switch head	Zinc diecast
Housing	Glass-fiber reinforced thermoplastic
Plug connectors	Nickel-plated brass
Mechanical life	1 x 10 ⁶ switching cycles

Ambient data

Enclosure rating	IP65 (EN 60529)
Ambient operating temperature	-20 °C ... +55 °C
Vibration resistance	10 Hz ... 55 Hz (IEC 60068-2-6)
Shock resistance	30 g, 11 ms (EN 60068-2-27)
EMC	EN IEC 60947-5-3

Classifications

ECLASS 5.0	27272603
ECLASS 5.1.4	27272603
ECLASS 6.0	27272603
ECLASS 6.2	27272603
ECLASS 7.0	27272603
ECLASS 8.0	27272603
ECLASS 8.1	27272603
ECLASS 9.0	27272603
ECLASS 10.0	27272603
ECLASS 11.0	27272603
ECLASS 12.0	27272603
ETIM 5.0	EC002593
ETIM 6.0	EC002593
ETIM 7.0	EC002593
ETIM 8.0	EC002593
UNSPSC 16.0901	39122205

Dimensional drawing (Dimensions in mm (inch))

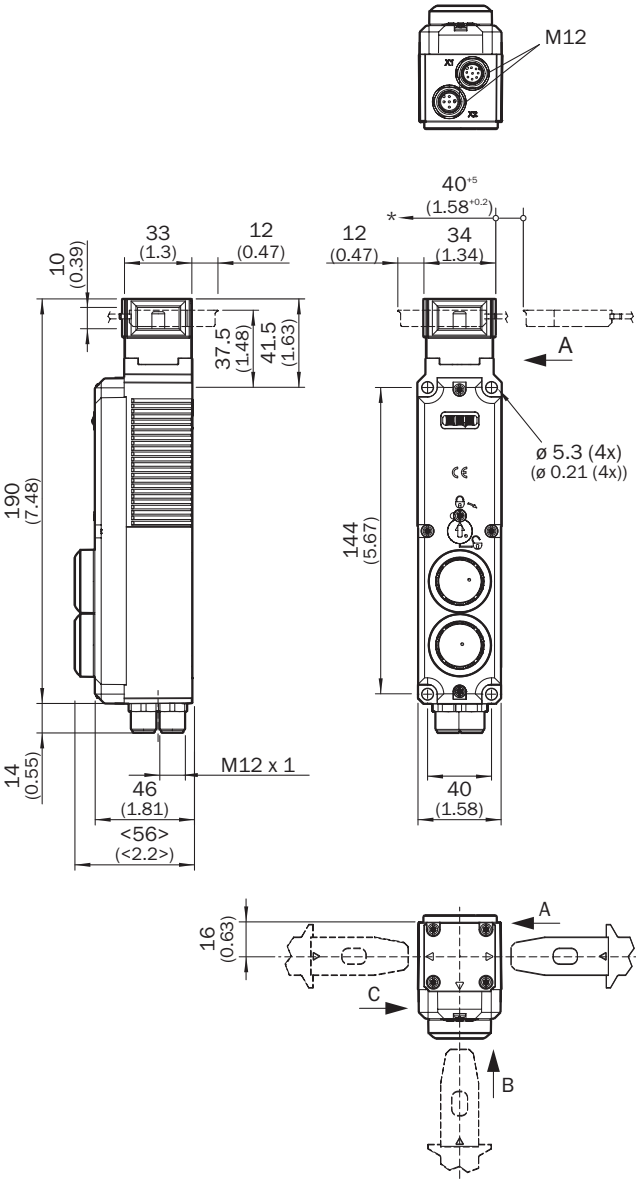

Pin assignment

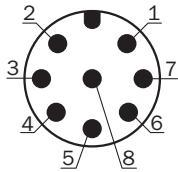

Pin	Designation	Description
1	AUX D00R	Door application diagnostic output
2	+24 V DC	Safety switch voltage supply
3	Magnet +	Magnet control 24 V DC
4	AUX DIAG	Error application diagnostic output
5	OSSD 1	OSSD 1 output
6	OSSD 2	OSSD 2 output
7	0 V	0 V DC voltage supply
8	AUX LOCK	Locking application diagnostic output

For details see operating instructions

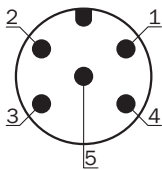





Pin	Designation	Description
1	NO1	Pushbutton 1, normally open
2	LED1	LED1
3	NO2	Pushbutton 2, normally open
4	LED2	LED2
5	Reset	Reset input

For details see operating instructions

Recommended accessories

Other models and accessories → www.sick.com/TR110_Lock

	Brief description	Type	Part no.
Actuators			
	Actuator angled	TR110-XABT	5334663
	Hinged actuators for doors with hinges on bottom ⁶	TR110-XAFB	5338338

	Brief description	Type	Part no.
	Hinged actuators for doors with hinges on left	TR110-XAFL	5338331
	Hinged actuators for doors with hinges on right	TR110-XAFR	5338332
	Hinged actuators for doors with hinges on top	TR110-XAFT	5338336
	Actuator straight	TR110-XAS	5321176

SICK AT A GLANCE

SICK is one of the leading manufacturers of intelligent sensors and sensor solutions for industrial applications. A unique range of products and services creates the perfect basis for controlling processes securely and efficiently, protecting individuals from accidents and preventing damage to the environment.

We have extensive experience in a wide range of industries and understand their processes and requirements. With intelligent sensors, we can deliver exactly what our customers need. In application centers in Europe, Asia and North America, system solutions are tested and optimized in accordance with customer specifications. All this makes us a reliable supplier and development partner.

Comprehensive services complete our offering: SICK LifeTime Services provide support throughout the machine life cycle and ensure safety and productivity.

For us, that is “Sensor Intelligence.”

WORLDWIDE PRESENCE:

Contacts and other locations –www.sick.com