



UFN3-70P417

UF

FORK SENSORS

SICK
Sensor Intelligence.



Illustration may differ



Ordering information

Type	Part no.
UFN3-70P417	6058743

Other models and accessories → www.sick.com/UF

Detailed technical data

Features

Functional principle detail	Ultrasonic detection principle
Dimensions (W x H x D)	18 mm x 47.5 mm x 92.5 mm
Housing design	Fork shaped
Fork width	3 mm
Fork depth	69 mm
Minimum detectable object (MDO)	Gap between Labels / Size of labels: 2 mm ¹⁾
Label detection	✓
Adjustment	Teach-in button, cable (Teach-in, sensitivity, light/dark switching, Teach-in dynamic)
Teach-in mode	1-point teach-in 2-point teach-in Teach-in dynamic

¹⁾ Depends on the label thickness.

Mechanics/electronics

Supply voltage	10 V DC ... 30 V DC ¹⁾
Ripple	< 10 % ²⁾
Current consumption	40 mA ³⁾
Switching frequency	1.5 kHz ⁴⁾
Response time	250 μs ⁵⁾
Switching output	PNP

¹⁾ Limit values, reverse-polarity protected, operation in short-circuit protected network: max. 8 A.

²⁾ May not exceed or fall below U_V tolerances.

³⁾ Without load.

⁴⁾ With light/dark ratio 1:1, typical, depending on material and speed.

⁵⁾ Signal transit time with resistive load.

⁶⁾ Output current minimal 0.03 mA.

⁷⁾ Reference voltage DC 50 V.

Switching output (voltage)	PNP: HIGH = $U_V \leq 2 \text{ V}$ / LOW approx. 0 V
Switching mode	Light/dark switching
Output current I_{max}	100 mA ⁶⁾
Input, teach-in (ET)	Teach: $U > 7 \text{ V} \dots < U_V$ Run: $U < 2 \text{ V}$
Initialization time	100 ms
Connection type	Male connector M8, 4-pin
Protection class	III ⁷⁾
Circuit protection	Output Q short-circuit protected Interference pulse suppression
Enclosure rating	IP65
Weight	95 g
Housing material	Metal, Aluminum

1) Limit values, reverse-polarity protected, operation in short-circuit protected network: max. 8 A.

2) May not exceed or fall below U_V tolerances.

3) Without load.

4) With light/dark ratio 1:1, typical, depending on material and speed.

5) Signal transit time with resistive load.

6) Output current minimal 0.03 mA.

7) Reference voltage DC 50 V.

Safety-related parameters

MTTF_D	207 years
DC_{avg}	0 %

Ambient data

Ambient operating temperature	+5 °C ... +55 °C ¹⁾
Ambient temperature, storage	-20 °C ... +70 °C
Shock load	According to EN 60068-2-27
EMC	EN 60947-5-2 ²⁾
UL File No.	NRKH.E191603 & NRKH7.E191603

1) Do not bend below 0 °C.

2) The UFN complies with the Radio Safety Requirements (EMC) for the industrial sector (Radio Safety Class A). It may cause radio interference if used in residential areas.

Classifications

ECLASS 5.0	27270909
ECLASS 5.1.4	27270909
ECLASS 6.0	27270909
ECLASS 6.2	27270909
ECLASS 7.0	27270909
ECLASS 8.0	27270909
ECLASS 8.1	27270909
ECLASS 9.0	27270909
ECLASS 10.0	27270909
ECLASS 11.0	27270909

ECLASS 12.0	27270909
ETIM 5.0	EC002720
ETIM 6.0	EC002720
ETIM 7.0	EC002720
ETIM 8.0	EC002720
UNSPSC 16.0901	39121528

Dimensional drawing (Dimensions in mm (inch))

UFnext - Teach-in button

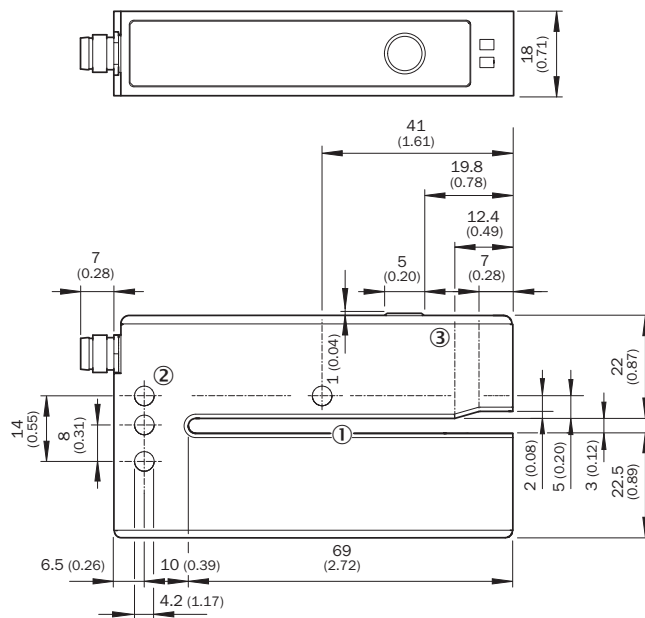

All dimensions in mm (inch)

- ① Fork opening: fork width 3 mm, forks depth 69 mm
- ② Mounting hole, \varnothing 4.2 mm
- ③ Detection axis

Adjustments

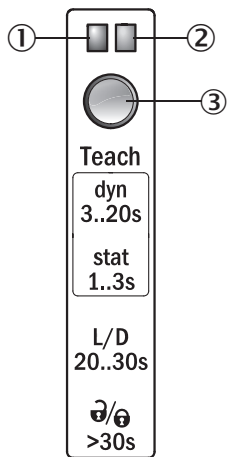

- ① Function signal indicator (yellow), switching output
- ② Function signal indicator (green)
- ③ Teach-in button and function button

Connection diagram

Cd-092

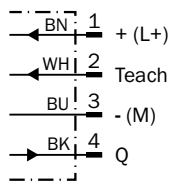

Concept of operation

Teach-in dynamic via Teach-in button

1. Start teach-in: Position carrier or label between the fork

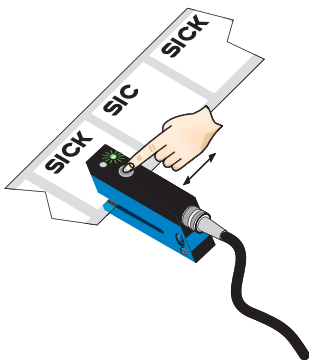

Press the teach-in button for 3 - 20 s. With the pushbutton pressed down, move several label with carrier material (label) through the sensor. The yellow LED flashes at 3 Hz during the teach-in procedure. Recommendation: Move at least 3 label + carrier through the sensor.

2. End teach-in:

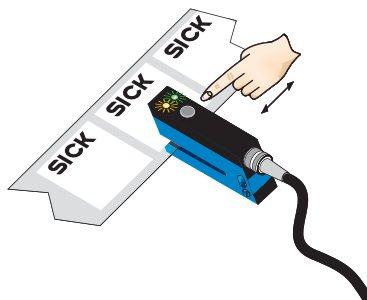

Release the teach-in button for < 20 s. If teach-in is successful, the function indicator (yellow LED) directly indicates the output state of the sensor. The switching threshold is now optimally set between carrier and label. The best possible operational safety is provided.

Note

Fine adjustment

In order to obtain a higher operating reserve, a fine adjustment can be carried out after successful teach-in. For this purpose, the switching threshold is set close to the taught-in object. The teach-in button must be pressed and released within 10 s of successful teach-in. Successful setting is signaled by flashing twice at 1 Hz.

Light/dark switching



- You can change between light switching and dark switching by pressing the teach-in button for 20 - 30 s.

Pushbutton lock

- The device can be locked against unintended operation by pressing the teach-in button for > 30 s. The device can be unlocked by pressing the teach-in button again for > 30 s.

Recommended accessories

Other models and accessories → www.sick.com/UF

	Brief description	Type	Part no.
Plug connectors and cables			
	<ul style="list-style-type: none"> • Connection type head A: Female connector, M8, 4-pin, straight, A-coded • Connection type head B: Flying leads • Signal type: Sensor/actuator cable • Cable: 5 m, 4-wire, PVC • Description: Sensor/actuator cable, unshielded • Application: Zones with chemicals 	YF8U14-050VA3XLEAX	2095889
	<ul style="list-style-type: none"> • Connection type head A: Female connector, M8, 4-pin, straight, A-coded • Connection type head B: Male connector, M12, 4-pin, straight, A-coded • Signal type: Sensor/actuator cable • Cable: 5 m, 4-wire, PVC • Description: Sensor/actuator cable, unshielded • Application: Zones with chemicals 	YF8U14-050VA3M2A14	2096609
	<ul style="list-style-type: none"> • Connection type head A: Male connector, M8, 4-pin, straight • Description: Unshielded • Connection systems: Screw-type terminals • Permitted cross-section: 0.14 mm² ... 0.5 mm² 	STE-0804-G	6037323

SICK AT A GLANCE

SICK is one of the leading manufacturers of intelligent sensors and sensor solutions for industrial applications. A unique range of products and services creates the perfect basis for controlling processes securely and efficiently, protecting individuals from accidents and preventing damage to the environment.

We have extensive experience in a wide range of industries and understand their processes and requirements. With intelligent sensors, we can deliver exactly what our customers need. In application centers in Europe, Asia and North America, system solutions are tested and optimized in accordance with customer specifications. All this makes us a reliable supplier and development partner.

Comprehensive services complete our offering: SICK LifeTime Services provide support throughout the machine life cycle and ensure safety and productivity.

For us, that is “Sensor Intelligence.”

WORLDWIDE PRESENCE:

Contacts and other locations –www.sick.com