



WFS3-40B41CA71

WFS

FORK SENSORS

SICK
Sensor Intelligence.



Illustration may differ



Ordering information

Type	Part no.
WFS3-40B41CA71	6058651

Other models and accessories → www.sick.com/WFS

Detailed technical data

Features

Functional principle	Fork sensor
Functional principle detail	Optical detection principle
Dimensions (W x H x D)	10 mm x 25 mm x 64.3 mm
Fork width	3 mm
Fork depth	42 mm
Minimum detectable object (MDO)	Gap between Labels / Size of labels: 2 mm ¹⁾
Label detection	✓
Light source	LED, infrared
Adjustment	Teach-in button, cable (Teach-in, sensitivity, light/dark switching, key lock, Teach-in dynamic)
Teach-in mode	1-point teach-in 2-point teach-in Teach-in dynamic

¹⁾ Depends on the label thickness.

Mechanics/electronics

Current consumption	20 mA ¹⁾
Switching frequency	15 kHz ²⁾
Stability of response time	± 20 µs
Jitter	17 µs
Switching output	Push-pull: PNP/NPN
Switching output (voltage)	Push-pull: PNP/NPN High = $U_V - < 2 V$ / Low: ≤ 2 V

¹⁾ Without load.

²⁾ With light/dark ratio 1:1, typical, during teach-in 6 kHz.

Switching mode	Light/dark switching
Output current I_{\max}	100 mA
Input, teach-in (ET)	Teach: $U > 5 \text{ V} \dots < U_V$ Run: $U < 4 \text{ V}$
Initialization time	40 ms
Time delay	Switch-off delay, 0 ms / 8 ms / 16 ms / 32 ms / 65 ms / 130 ms / 260 ms / 520 ms, adjustable via IO-Link (0 ms = default)
Connection type	Male connector M8, 4-pin
Protection class	III
Circuit protection	U_V connections, reverse polarity protected Output Q short-circuit protected Interference pulse suppression
Enclosure rating	IP65
Weight	Approx. 36 g
Housing material	Plastic, PA (glass-fiber reinforced)

¹⁾ Without load.

²⁾ With light/dark ratio 1:1, typical, during teach-in 6 kHz.

Safety-related parameters

MTTF_D	97 years
DC_{avg}	0 %

Communication interface

IO-Link	✓
VendorID	26
DeviceID HEX	8000B0
DeviceID DEC	8388784
Cycle time	2.3 ms
Process data structure A	Bit 0 = switching signal Q_{L1} Bit 1 = switching signal Q_{L2} Bit 2 = not used Bit 3 = Teach busy Bit 4 ... 15 = empty
Process data structure B	Bit 0 = switching signal Q_{L1} Bit 1 = Quality of Run Alarm Bit 2 = not used Bit 3 = Teach busy Bit 4 ... 15 = empty
Process data structure C	Bit 0 = switching signal Q_{L1} Bit 1 = switching signal Q_{L2} Bit 2 = not used Bit 3 = Teach busy Bit 4 ... 5 = empty Bit 6 ... 15 = measuring value
Process data structure D	Bit 0 = switching signal Q_{L1} Bit 1 = Quality of Run Alarm Bit 2 = not used Bit 3 = Teach busy Bit 4 ... 5 = empty Bit 6 ... 15 = measuring value
Process data structure E	Bit 0 = switching signal Q_{L1} (AFC Q1 Output) Bit 1 = switching signal Q_{L2} (AFC Q2 Output)

Bit 2 ... 15 = counting value

Ambient data

Shock load	According to EN 60068-2-27
UL File No.	NRKH.E191603

Classifications

ECLASS 5.0	27270909
ECLASS 5.1.4	27270909
ECLASS 6.0	27270909
ECLASS 6.2	27270909
ECLASS 7.0	27270909
ECLASS 8.0	27270909
ECLASS 8.1	27270909
ECLASS 9.0	27270909
ECLASS 10.0	27270909
ECLASS 11.0	27270909
ECLASS 12.0	27270909
ETIM 5.0	EC002720
ETIM 6.0	EC002720
ETIM 7.0	EC002720
ETIM 8.0	EC002720
UNSPSC 16.0901	39121528

Dimensional drawing (Dimensions in mm (inch))

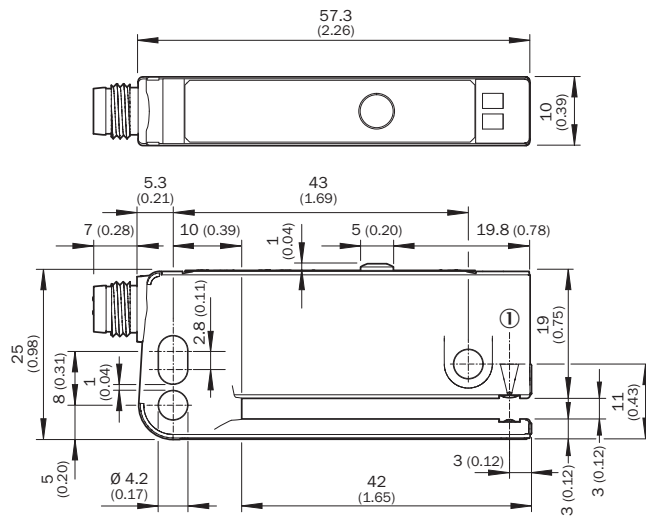

Adjustments

Adjustment: teach-in via Teach-in button (WFxx-B41Cxx)



- ① Function signal indicator (yellow), switching output
- ② Function signal indicator (green)
- ③ Teach-in button and function button

Connection diagram

Cd-273



Concept of operation

Teach-in dynamic via Teach-in button

1. Start teach-in: Position carrier or label between the fork

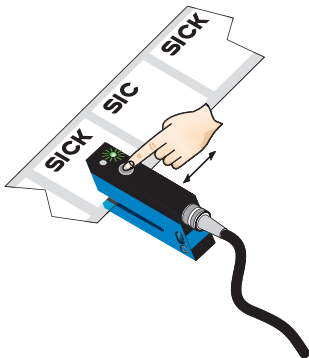

Press the teach-in button for 3 - 20 s. With the pushbutton pressed down, move several label with carrier material (label) through the sensor. The yellow LED flashes at 3 Hz during the teach-in procedure. Recommendation: Move at least 3 label + carrier through the sensor.

2. End teach-in:

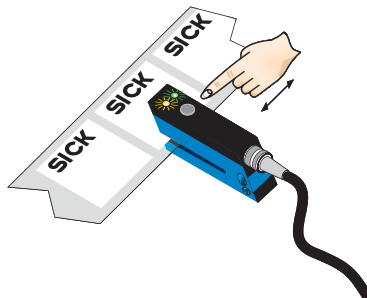

Release the teach-in button for < 20 s. If teach-in is successful, the function indicator (yellow LED) directly indicates the output state of the sensor. The switching threshold is now optimally set between carrier and label. The best possible operational safety is provided.

Note

Fine adjustment

In order to obtain a higher operating reserve, a fine adjustment can be carried out after successful teach-in. For this purpose, the switching threshold is set close to the taught-in object. The teach-in button must be pressed and released within 10 s of successful teach-in. Successful setting is signaled by flashing twice at 1 Hz.

Light/dark switching











- You can change between light switching and dark switching by pressing the teach-in button for 20 - 30 s.

Pushbutton lock

- The device can be locked against unintended operation by pressing the teach-in button for > 30 s. The device can be unlocked by pressing the teach-in button again for > 30 s.

Recommended accessories

Other models and accessories → www.sick.com/WFS

	Brief description	Type	Part no.
Cloning modules			
	IO-Link version V1.1, Port class 2, PIN 2, 4, 5 galvanically connected, Supply voltage 18 V DC ... 32 V DC (limit values, operation in short-circuit protected network max. 8 A)	IOLP2ZZ-M3201 (SICK Memory Stick)	1064290
	IO-Link V1.1 Class A port, USB2.0 port, optional external power supply 24V / 1A	IOLA2US-01101 (SiLink2 Master)	1061790
	EtherCAT IO-Link Master, IO-Link V1.1, Port Class A, power supply via 7/8" cable 24 V / 8 A, fieldbus connection via M12 cable	IOLG2EC-03208R01 (IO-Link Master)	6053254
Universal bar clamp systems			
	WFS mounting rod, straight, including 2 x fixing screws, Aluminum	BEF-M12GF-A	2059414
	Bar clamp for bar diameter of 12 mm (fixing the mounting rod), Aluminum, 2 screws M6 x 30, 2 spring discs	BEF-RMC-D12	5321878
Plug connectors and cables			
	<ul style="list-style-type: none"> Connection type head A: Female connector, M8, 4-pin, straight, A-coded Connection type head B: Flying leads Signal type: Sensor/actuator cable Cable: 5 m, 4-wire, PVC Description: Sensor/actuator cable, unshielded Application: Zones with chemicals 	YF8U14-050VA3XLEAX	2095889
	<ul style="list-style-type: none"> Connection type head A: Female connector, M8, 4-pin, straight, A-coded Connection type head B: Male connector, M12, 4-pin, straight, A-coded Signal type: Sensor/actuator cable Cable: 5 m, 4-wire, PVC Description: Sensor/actuator cable, unshielded Application: Zones with chemicals 	YF8U14-050VA3M2A14	2096609
	<ul style="list-style-type: none"> Connection type head A: Male connector, M8, 4-pin, straight Description: Unshielded Connection systems: Screw-type terminals Permitted cross-section: 0.14 mm² ... 0.5 mm² 	STE-0804-G	6037323
Sensor Integration Gateway			
	<ul style="list-style-type: none"> Further functions: Web server integrated, USB connection for easy configuration of the SIG200 Sensor Integration Gateway with SOPAS ET, the engineering tool from SICK, logic editor is available for easy configuration of logic functions Connection CONFIG: 1 x M8, 4-pin female connector, USB 2.0 (USB-A) Logic editor: yes Communication interface: IO-Link, USB, Ethernet, PROFINET, REST API Product category: IO-Link Master 	SIG200-0A0412200	1089794
	<ul style="list-style-type: none"> Further functions: Web server integrated, USB connection for easy configuration of the SIG200 Sensor Integration Gateway with SOPAS ET, the engineering tool from SICK, logic editor is available for easy configuration of logic functions Connection CONFIG: 1 x M8, 4-pin female connector, USB 2.0 (USB-A) Logic editor: yes Communication interface: IO-Link, USB, Ethernet, REST API Product category: IO-Link Master 	SIG200-0A0G12200	1102605

Recommended services

Additional services → www.sick.com/WFS

	Type	Part no.
Function Block Factory		
<ul style="list-style-type: none">• Description: The Function Block Factory supports common programmable logic controllers (PLCs) from various manufacturers, such as Siemens, Beckhoff, Rockwell Automation and B&R. More information on the FBF can be found <a _blank"="" href="https://fbf.cloud.sick.com target=">here.• Note: You can configure your function block at <a _blank"="" href="https://fbf.cloud.sick.com target=">Function Block Factory. As a login please use your SICK ID.	Function Block Factory	On request

SICK AT A GLANCE

SICK is one of the leading manufacturers of intelligent sensors and sensor solutions for industrial applications. A unique range of products and services creates the perfect basis for controlling processes securely and efficiently, protecting individuals from accidents and preventing damage to the environment.

We have extensive experience in a wide range of industries and understand their processes and requirements. With intelligent sensors, we can deliver exactly what our customers need. In application centers in Europe, Asia and North America, system solutions are tested and optimized in accordance with customer specifications. All this makes us a reliable supplier and development partner.

Comprehensive services complete our offering: SICK LifeTime Services provide support throughout the machine life cycle and ensure safety and productivity.

For us, that is “Sensor Intelligence.”

WORLDWIDE PRESENCE:

Contacts and other locations –www.sick.com