



# GLL170-P334S06

GLL170

FIBER-OPTIC SENSORS

**SICK**  
Sensor Intelligence.

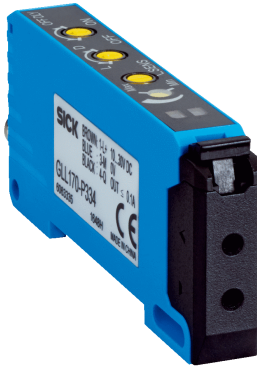

Illustration may differ



### Ordering information

Type	Part no.
GLL170-P334S06	6071258

Other models and accessories → [www.sick.com/GLL170](http://www.sick.com/GLL170)

### Detailed technical data

#### Features

<b>Device type</b>	Fiber-optic sensors
<b>Device type detail</b>	Stand-alone
<b>Dimensions (W x H x D)</b>	10 mm x 31.7 mm x 72.5 mm
<b>Housing design (light emission)</b>	Rectangular
<b>Sensing range max.</b>	0 mm ... 190 mm, Proximity system <sup>1) 2)</sup> 0 mm ... 800 mm, Through-beam system <sup>3)</sup>
<b>Sensing range</b>	0 mm ... 160 mm, Proximity system <sup>1) 2)</sup> 0 mm ... 700 mm, Through-beam system <sup>3)</sup>
<b>Type of light</b>	Visible red light
<b>Light source</b>	LED <sup>4)</sup>
<b>Wave length</b>	632 nm
<b>Adjustment</b>	Potentiometer, 8 turns <sup>5)</sup>
<b>Indication</b>	LED
<b>Display</b>	Status LEDs

<sup>1)</sup> Object with 90 % reflectance (referred to standard white, DIN 5033).

<sup>2)</sup> LL3-DK06.

<sup>3)</sup> LL3-TB02.

<sup>4)</sup> Average service life: 100,000 h at T<sub>J</sub> = +25 °C.

<sup>5)</sup> Sensitivity scale 230°.

## Mechanics/electronics

<b>Supply voltage</b>	10 V DC ... 30 V DC <sup>1)</sup>
<b>Ripple</b>	≤ 10 % <sup>2)</sup>
<b>Current consumption</b>	30 mA <sup>3)</sup>
<b>Switching output</b>	PNP
<b>Number of switching outputs</b>	1
<b>Switching mode</b>	Light/dark switching
<b>Switching mode selector</b>	Selectable via rotary switch
<b>Response time</b>	≤ 250 μs <sup>4)</sup>
<b>Switching frequency</b>	2 kHz
<b>Time functions</b>	Without time delay Off delay
<b>Delay time</b>	Selectable via rotary switch, 0 ms ... 40 ms
<b>Connection type</b>	Male connector M8, 4-pin
<b>Cable material</b>	PVC
<b>Conductor cross-section</b>	0.2 mm <sup>2</sup>
<b>Cable diameter</b>	Ø 3.8 mm
<b>Circuit protection</b>	A <sup>5)</sup> B <sup>6)</sup> C <sup>7)</sup> D <sup>8)</sup>
<b>Protection class</b>	III
<b>Weight</b>	19 g
<b>Housing material</b>	Plastic, PC/POM
<b>Tightening torque, max.</b>	0.5 Nm
<b>Enclosure rating</b>	IP66 <sup>9)</sup>
<b>Items supplied</b>	BEF-WLL180 mounting bracket
<b>Ambient operating temperature</b>	-25 °C ... +55 °C
<b>Ambient temperature, storage</b>	-40 °C ... +70 °C
<b>UL File No.</b>	NRKH2.E300503 & NRKH8.E300503

<sup>1)</sup> Limit values.

<sup>2)</sup> May not exceed or fall below U<sub>v</sub> tolerances.

<sup>3)</sup> Without load.

<sup>4)</sup> Signal transit time with resistive load.

<sup>5)</sup> A = V<sub>S</sub> connections reverse-polarity protected.

<sup>6)</sup> B = inputs and output reverse-polarity protected.

<sup>7)</sup> C = interference suppression.

<sup>8)</sup> D = outputs overcurrent and short-circuit protected.

<sup>9)</sup> With correctly attached fibre-optic cable LL3.

## Classifications

<b>ECl@ss 5.0</b>	27270905
<b>ECl@ss 5.1.4</b>	27270905
<b>ECl@ss 6.0</b>	27270905
<b>ECl@ss 6.2</b>	27270905

<b>ECl@ss 7.0</b>	27270905
<b>ECl@ss 8.0</b>	27270905
<b>ECl@ss 8.1</b>	27270905
<b>ECl@ss 9.0</b>	27270905
<b>ECl@ss 10.0</b>	27270905
<b>ECl@ss 11.0</b>	27270905
<b>ETIM 5.0</b>	EC002651
<b>ETIM 6.0</b>	EC002651
<b>ETIM 7.0</b>	EC002651
<b>ETIM 8.0</b>	EC002651
<b>UNSPSC 16.0901</b>	39121528

### Connection diagram

Cd-066

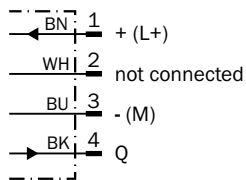

### Adjustments

GLL170

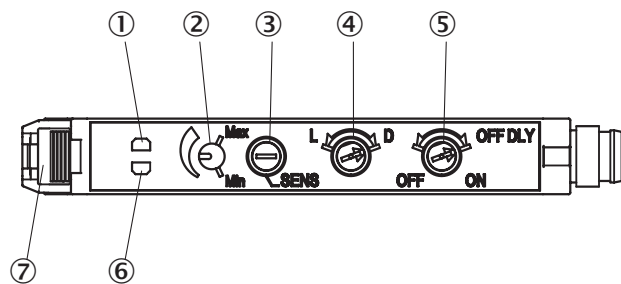

- ① LED indicator orange, lights up when switching output is active
- ② Sensitivity scale 230°
- ③ Sensitivity control: potentiometer, 8 turns
- ④ Selector switch: "L.ON" ( light switching) / "D.ON" ( dark switching)
- ⑤ OFF delay selector switch: "ON" (on) / "OFF" (off), 40 ms fixed
- ⑥ LED signal strength indicator green, lights up, when light received < 0.9 or > 1.1 (switching threshold = 1)
- ⑦ Locking the fiber-optic cables

Dimensional drawing (Dimensions in mm (inch))

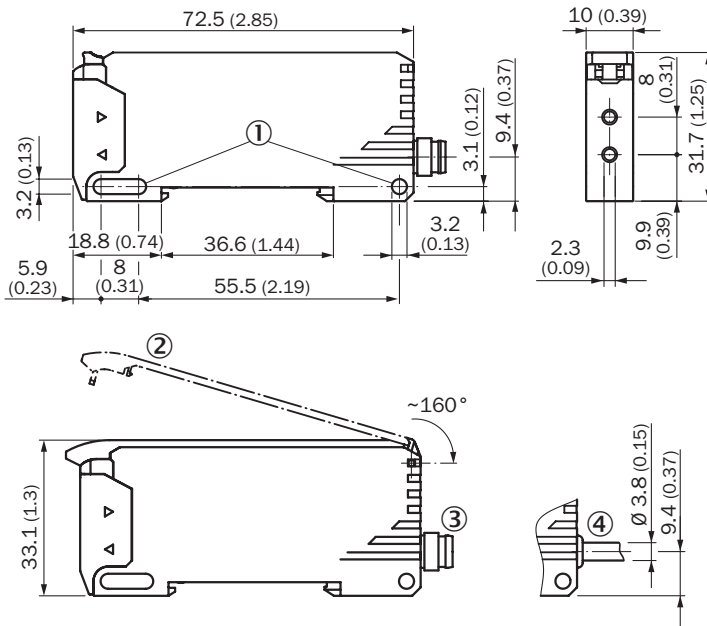





- ① Mounting holes
- ② Protective hood (optional), opens approx. 160°
- ③ Connector M8
- ④ Cable

Recommended accessories

Other models and accessories → [www.sick.com/GLL170](http://www.sick.com/GLL170)

	Brief description	Type	Part no.
<b>Device protection (mechanical)</b>			
	Protective Hood for GLL170, opens approx. 160°, PC	BF-GLL170	5336263
<b>Mounting brackets and plates</b>			
	Mounting bracket, steel, zinc coated, without mounting hardware	BEF-WLL180	5325812
<b>Plug connectors and cables</b>			
	Head A: female connector, M8, 4-pin, straight, A-coded Head B: Flying leads Cable: Sensor/actuator cable, PVC, unshielded, 2 m	YF8U14-020VA3XLEAX	2095888
	Head A: female connector, M8, 4-pin, straight, A-coded Head B: Flying leads Cable: Sensor/actuator cable, PVC, unshielded, 5 m	YF8U14-050VA3XLEAX	2095889
	Head A: female connector, M8, 4-pin, straight, A-coded Head B: Flying leads Cable: Sensor/actuator cable, PVC, unshielded, 10 m	YF8U14-100VA3XLEAX	2095890

	Brief description	Type	Part no.
	Head A: female connector, M8, 4-pin, angled, A-coded Head B: Flying leads Cable: Sensor/actuator cable, PVC, unshielded, 2 m	YG8U14-020VA3XLEAX	2095962
	Head A: female connector, M8, 4-pin, angled, A-coded Head B: Flying leads Cable: Sensor/actuator cable, PVC, unshielded, 5 m	YG8U14-050VA3XLEAX	2095963
	Head A: female connector, M8, 4-pin, angled, A-coded Head B: Flying leads Cable: Sensor/actuator cable, PVC, unshielded, 10 m	YG8U14-100VA3XLEAX	2095964
	Head A: female connector, M8, 4-pin, straight Head B: - Cable: unshielded	DOS-0804-G	6009974
	Head A: female connector, M8, 4-pin, angled Head B: - Cable: unshielded	DOS-0804-W	6009975
	Head A: male connector, M8, 4-pin, straight Head B: - Cable: unshielded	STE-0804-G	6037323
<b>Fibers</b>			
	LL3-DB01	LL3-DB01	5308074
	LL3-DB02	LL3-DB02	5308083
	LL3-DC38	LL3-DC38	5322472
	LL3-DR11	LL3-DR11	5326000
	LL3-DT01	LL3-DT01	5308076
	LL3-DV05	LL3-DV05	5322549
	LL3-TB01	LL3-TB01	5308050
	LL3-TH08	LL3-TH08	5325978
	LL3-TS40	LL3-TS40	5323971
	LL3-TV05	LL3-TV05	5322546
	LL3-TX01	LL3-TX01	5324173
	LL3-TY01	LL3-TY01	5308066

## SICK AT A GLANCE

SICK is one of the leading manufacturers of intelligent sensors and sensor solutions for industrial applications. A unique range of products and services creates the perfect basis for controlling processes securely and efficiently, protecting individuals from accidents and preventing damage to the environment.

We have extensive experience in a wide range of industries and understand their processes and requirements. With intelligent sensors, we can deliver exactly what our customers need. In application centers in Europe, Asia and North America, system solutions are tested and optimized in accordance with customer specifications. All this makes us a reliable supplier and development partner.

Comprehensive services complete our offering: SICK LifeTime Services provide support throughout the machine life cycle and ensure safety and productivity.

For us, that is “Sensor Intelligence.”

## WORLDWIDE PRESENCE:

Contacts and other locations –[www.sick.com](http://www.sick.com)