



# WLL180T-F434

WLL180

FIBER-OPTIC SENSORS

**SICK**  
Sensor Intelligence.



Illustration may differ



### Ordering information

Type	Part no.
WLL180T-F434	6039102

**Included in delivery:** BEF-WLL180 (1)

Other models and accessories → [www.sick.com/WLL180](http://www.sick.com/WLL180)

### Detailed technical data

#### Features

<b>Device type</b>	Fiber-optic sensors
<b>Device type detail</b>	Expansion unit
<b>Dimensions (W x H x D)</b>	10.5 mm x 34.6 mm x 71.9 mm
<b>Housing design (light emission)</b>	Rectangular
<b>Sensing range max.</b>	0 m ... 20 m (Through-beam system) <sup>1) 2)</sup>
<b>Sensing range</b>	0 mm ... 1,400 mm, Proximity system <sup>3) 4)</sup> 0 m ... 18 m, Through-beam system <sup>1) 2)</sup>
<b>Focus</b>	Approx. 65° <sup>5)</sup>
<b>Type of light</b>	Visible red light
<b>Light source</b>	LED <sup>6)</sup>
<b>Angle of dispersion</b>	Approx. 65° <sup>5)</sup>
<b>Wave length</b>	650 nm
<b>Adjustment</b>	Menu-controlled Single teach-in button Cable
<b>Indication</b>	7-segment
<b>Display</b>	LED status display / 2x 4-character digital dual displays, Set value (green indicator) and actual value (red indicator) are displayed simultaneously, display of parameters

<sup>1)</sup> Sensing range with 8 ms response time. Reduction with shorter response time (see tables LL3/WLL180T).

<sup>2)</sup> LL3-TX01.

<sup>3)</sup> Object with 90% remission (based on standard white DIN 5033). Sensing range at 8 ms response time. Reduced at shorter response times (see LL3 / WLL180T tables).

<sup>4)</sup> LL3-DK06.

<sup>5)</sup> See LL3 fiber-optic data.

<sup>6)</sup> Average service life: 100,000 h at T<sub>U</sub> = +25 °C.

## Mechanics/electronics

<b>Supply voltage <math>U_B</math></b>	12 V DC ... 24 V DC <sup>1)</sup>
<b>Ripple</b>	$\leq 10\%$ <sup>2)</sup>
<b>Current consumption</b>	50 mA <sup>3)</sup>
<b>Switching output</b>	PNP
<b>Number of switching outputs</b>	1
<b>Switching mode</b>	Light/dark switching
<b>Switching mode selector</b>	Manually selectable
<b>Response time</b>	$\leq 16\ \mu\text{s}$ , $\leq 70\ \mu\text{s}$ , $\leq 250\ \mu\text{s}$ , $\leq 2,000\ \mu\text{s}$ , $\leq 8,000\ \mu\text{s}$ <sup>4)</sup>
<b>Switching frequency</b>	31.2 kHz, 7.1 kHz, 2 kHz, 250 Hz, 62.5 Hz
<b>Time functions</b>	Without time delayoff delayon delayON and OFF delayone shot
<b>Delay time</b>	Programmable, 0 ms ... 9,999 ms
<b>Input</b>	Multifunctional input MF
<b>Connection type</b>	Male connector M8, 4-pin
<b>Circuit protection</b>	A <sup>5)</sup> B <sup>6)</sup> C <sup>7)</sup> D <sup>8)</sup>
<b>Protection class</b>	III
<b>Weight</b>	20 g
<b>Housing material</b>	Plastic, ABS/PC
<b>Enclosure rating</b>	IP50 <sup>9)</sup>
<b>Items supplied</b>	BEF-WLL180 mounting bracket
<b>Ambient operating temperature</b>	$-25\ ^\circ\text{C}$ ... $+55\ ^\circ\text{C}$ <sup>10)</sup>
<b>Ambient temperature, storage</b>	$-40\ ^\circ\text{C}$ ... $+70\ ^\circ\text{C}$
<b>UL File No.</b>	NRKH.E300503 & NRKH7.E300503

1)  $\pm 10\%$ .

2) May not exceed or fall below  $U_v$  tolerances.

3) Without load.

4) Selectable.

5) A =  $V_S$  connections reverse-polarity protected.

6) B = inputs and output reverse-polarity protected.

7) C = interference suppression.

8) D = outputs overcurrent and short-circuit protected.

9) With correctly attached fibre-optic cable LL3 and closed protection hood.

10) Operating temperature fluctuates according to number of devices connected: 4–8 devices:  $-25\ ^\circ\text{C}$  ...  $+50\ ^\circ\text{C}$  (output current 50 mA) / 9–16 devices:  $-25\ ^\circ\text{C}$  ...  $+45\ ^\circ\text{C}$  (output current 20 mA).

## Safety-related parameters

<b>MTTF<sub>D</sub></b>	317 years
<b>DC<sub>avg</sub></b>	0 %

## Classifications

<b>ECLASS 5.0</b>	27270905
<b>ECLASS 5.1.4</b>	27270905
<b>ECLASS 6.0</b>	27270905

<b>ECLASS 6.2</b>	27270905
<b>ECLASS 7.0</b>	27270905
<b>ECLASS 8.0</b>	27270905
<b>ECLASS 8.1</b>	27270905
<b>ECLASS 9.0</b>	27270905
<b>ECLASS 10.0</b>	27270905
<b>ECLASS 11.0</b>	27270905
<b>ECLASS 12.0</b>	27270905
<b>ETIM 5.0</b>	EC002651
<b>ETIM 6.0</b>	EC002651
<b>ETIM 7.0</b>	EC002651
<b>ETIM 8.0</b>	EC002651
<b>UNSPSC 16.0901</b>	39121528

### Adjustments

WLL180

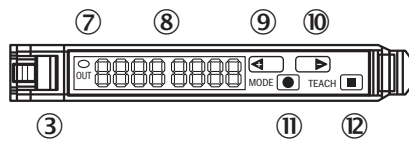

- ③ Locking the fiber-optic cables
- ⑦ LED indicator orange, lights up when switching output is active
- ⑧ Numeric display 2 x 4-digit; green: switching threshold, operating mode; red: actual value, Teach-in and function parameter
- ⑨ Step pushbutton > (manual switching threshold: higher/next function parameter)
- ⑩ Step pushbutton < (manual switching threshold: lower/previous function parameter)
- ⑪ Mode/Enter-button
- ⑫ Teach-in button

### Connection type

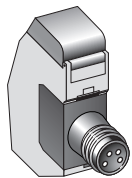

## Connection diagram

Cd-140

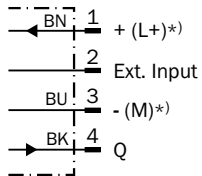

\*) Only base unit

## Dimensional drawing (Dimensions in mm (inch))

Expansion unit

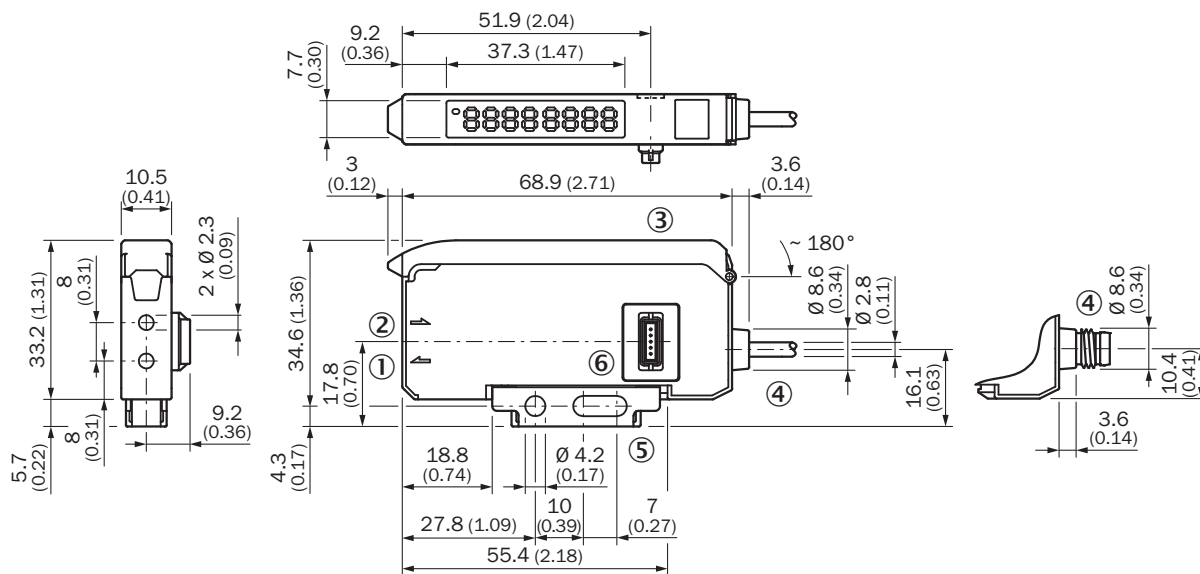



- ① Sender LED, installation of LL3 fibre-optic cable (sender fibre)
- ② Receiver, installation of LL3 fibre optic cable (receiver fibre)
- ③ Protective hood opens approx. 180°
- ④ Connection
- ⑤ Mounting bracket, included with delivery
- ⑥ Bus connector

## Recommended accessories

Other models and accessories → [www.sick.com/WLL180](http://www.sick.com/WLL180)

	Brief description	Type	Part no.
Fieldbus modules			
	EtherCAT coupler for WLL180T, KTL180 and AOD1. Features: EtherCAT; transmission rates of up to 100 Mbaud; M12 EtherCAT connection; M8 voltage supply connection, 4-pin; full read/write functionality for the process and service data of the connected sensors. See operating instructions for additional information and technical details	W1180C-EC	6068089

	Brief description	Type	Part no.
	PROFINET coupler for WLL180T, KTL180 and AOD1. Features: PROFINET IRT; transmission rates 10 Mbaud – 100 Mbaud; M12 PROFINET connection; M8 voltage supply connection, 4-pin; full read/write functionality for the process and service data of the connected sensors. See operating instructions for additional information and technical details	WI180C-PN	6068088
	IO-Link Smart Sensor Gateway for WLL180T, KTL180 and AOD1; Features: IO-Link; COM3; M8 connection, 4-pin; full read/write functionality for the process and service data of the connected sensors. See operating instructions for additional information and technical details	WI180C-IOA00	6071650
Plug connectors and cables			
	<ul style="list-style-type: none"> <li>• <b>Connection type head A:</b> Female connector, M8, 4-pin, straight, A-coded</li> <li>• <b>Connection type head B:</b> Flying leads</li> <li>• <b>Signal type:</b> Sensor/actuator cable</li> <li>• <b>Cable:</b> 2 m, 4-wire, PVC</li> <li>• <b>Description:</b> Sensor/actuator cable, unshielded</li> <li>• <b>Application:</b> Zones with chemicals</li> </ul>	YF8U14-020VA3XLEAX	2095888
	<ul style="list-style-type: none"> <li>• <b>Connection type head A:</b> Female connector, M8, 4-pin, straight, A-coded</li> <li>• <b>Connection type head B:</b> Flying leads</li> <li>• <b>Signal type:</b> Sensor/actuator cable</li> <li>• <b>Cable:</b> 5 m, 4-wire, PVC</li> <li>• <b>Description:</b> Sensor/actuator cable, unshielded</li> <li>• <b>Application:</b> Zones with chemicals</li> </ul>	YF8U14-050VA3XLEAX	2095889
	<ul style="list-style-type: none"> <li>• <b>Connection type head A:</b> Female connector, M8, 4-pin, angled, A-coded</li> <li>• <b>Connection type head B:</b> Flying leads</li> <li>• <b>Signal type:</b> Sensor/actuator cable</li> <li>• <b>Cable:</b> 2 m, 4-wire, PVC</li> <li>• <b>Description:</b> Sensor/actuator cable, unshielded</li> <li>• <b>Application:</b> Zones with chemicals</li> </ul>	YG8U14-020VA3XLEAX	2095962
	<ul style="list-style-type: none"> <li>• <b>Connection type head A:</b> Female connector, M8, 4-pin, angled, A-coded</li> <li>• <b>Connection type head B:</b> Flying leads</li> <li>• <b>Signal type:</b> Sensor/actuator cable</li> <li>• <b>Cable:</b> 5 m, 4-wire, PVC</li> <li>• <b>Description:</b> Sensor/actuator cable, unshielded</li> <li>• <b>Application:</b> Zones with chemicals</li> </ul>	YG8U14-050VA3XLEAX	2095963
Fibers			
	LL3-DB01	LL3-DB01	5308074
	LL3-DB02	LL3-DB02	5308083
	LL3-DC38	LL3-DC38	5322472
	LL3-DR11	LL3-DR11	5326000
	LL3-DT01	LL3-DT01	5308076
	LL3-DV05	LL3-DV05	5322549
	LL3-TB01	LL3-TB01	5308050
	LL3-TS40	LL3-TS40	5323971
	LL3-TV05	LL3-TV05	5322546
	LL3-TX01	LL3-TX01	5324173
	LL3-TY01	LL3-TY01	5308066

## SICK AT A GLANCE

SICK is one of the leading manufacturers of intelligent sensors and sensor solutions for industrial applications. A unique range of products and services creates the perfect basis for controlling processes securely and efficiently, protecting individuals from accidents and preventing damage to the environment.

We have extensive experience in a wide range of industries and understand their processes and requirements. With intelligent sensors, we can deliver exactly what our customers need. In application centers in Europe, Asia and North America, system solutions are tested and optimized in accordance with customer specifications. All this makes us a reliable supplier and development partner.

Comprehensive services complete our offering: SICK LifeTime Services provide support throughout the machine life cycle and ensure safety and productivity.

For us, that is “Sensor Intelligence.”

## WORLDWIDE PRESENCE:

Contacts and other locations –[www.sick.com](http://www.sick.com)