



# PLG3-120F431

PLG

SWITCHING AUTOMATION LIGHT GRIDS

**SICK**  
Sensor Intelligence.



Illustration may differ



### Ordering information

Type	Part no.
PLG3-120F431	1028953

Other models and accessories → [www.sick.com/PLG](http://www.sick.com/PLG)

### Detailed technical data

#### Features

<b>Sensor principle</b>	Photoelectric retro-reflective sensor
<b>Minimum detectable object (MDO)</b>	35 mm <sup>1)</sup>
<b>Beam separation</b>	30 mm
<b>Number of beams</b>	5
<b>Detection height</b>	120 mm

<sup>1)</sup> See characteristic curve.

#### Mechanics/electronics

<b>Wave length</b>	650 nm
<b>Supply voltage V<sub>s</sub></b>	DC 15 V ... 30 V <sup>1)</sup>
<b>Power consumption sender</b>	< 45 mA
<b>Ripple</b>	< 5 V <sub>pp</sub>
<b>Output current I<sub>max.</sub></b>	≤ 100 mA
<b>Output load, capacitive</b>	100 nF
<b>Output load, Inductive</b>	1 H
<b>Initialization time</b>	0.6 s
<b>Switching output</b>	PNP <sup>2)</sup>
<b>Output mode</b>	Q dark switching <sup>3)</sup>
<b>Current consumption job LED</b>	10 mA <sup>1)</sup>
<b>Dimensions (W x H x D)</b>	19.2 mm x 199.8 mm x 36.6 mm
<b>Connection type</b>	Cable with M12 male connector, 4-pin, 280 mm
<b>Housing material</b>	Aluminum
<b>Indication</b>	LED

<sup>1)</sup> Typical value.

<sup>2)</sup> Q.

<sup>3)</sup> Q = active, if at least one beam is interrupted, /Q = active, if all of the beams are free.

<b>Enclosure rating</b>	IP54
<b>Circuit protection</b>	U <sub>v</sub> connections, reverse polarity protected Output Q short-circuit protected Interference pulse suppression
<b>Protection class</b>	III
<b>Weight</b>	200 g
<b>Front screen</b>	PMMA

1) Typical value.

2) Q.

3) Q = active, if at least one beam is interrupted, /Q = active, if all of the beams are free.

### Performance

<b>Maximum range</b>	2 m
<b>Minimum range</b>	≥ 110 mm
<b>Operating range</b>	1.3 m
<b>Response time</b>	< 80 ms <sup>1)</sup>

1) With resistive load.

### Ambient data

<b>Shock resistance</b>	10 g / DIN EN 60068-2-29 / 16 ms
<b>Vibration resistance</b>	5 g, 10 Hz ... 55 Hz (IEC 68-2-6)
<b>EMC</b>	EN 60947-5-2
<b>Ambient operating temperature</b>	-10 °C ... +55 °C
<b>Ambient temperature, storage</b>	-40 °C ... +70 °C

### Classifications

<b>eCl@ss 5.0</b>	27270910
<b>eCl@ss 5.1.4</b>	27270910
<b>eCl@ss 6.0</b>	27270910
<b>eCl@ss 6.2</b>	27270910
<b>eCl@ss 7.0</b>	27270910
<b>eCl@ss 8.0</b>	27270910
<b>eCl@ss 8.1</b>	27270910
<b>eCl@ss 9.0</b>	27270910
<b>eCl@ss 10.0</b>	27270910
<b>eCl@ss 11.0</b>	27270910
<b>eCl@ss 12.0</b>	27270910
<b>ETIM 5.0</b>	EC002549
<b>ETIM 6.0</b>	EC002549
<b>ETIM 7.0</b>	EC002549
<b>ETIM 8.0</b>	EC002549
<b>UNSPSC 16.0901</b>	39121528

### Dimensional drawing (Dimensions in mm (inch))

PLG3

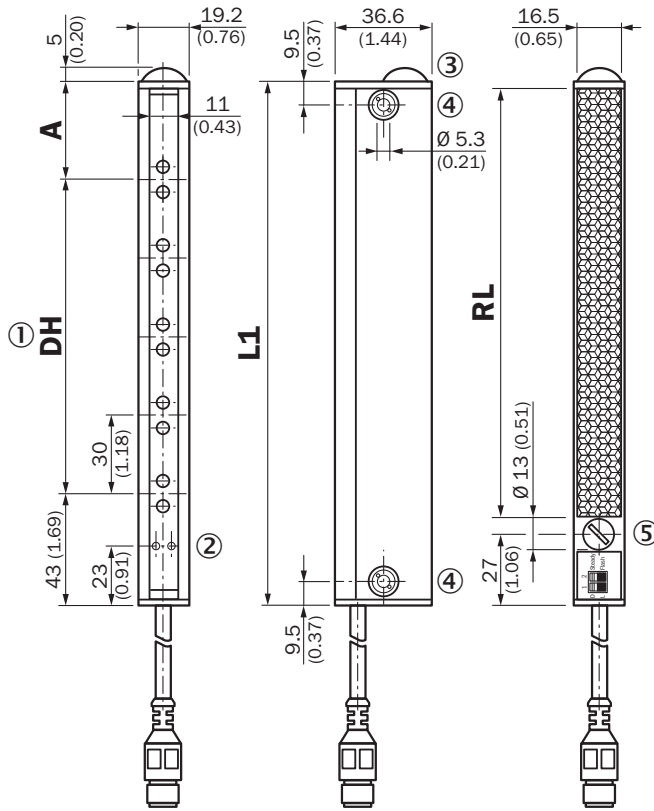

DH	A	L1	RL
<b>120 (4.72)</b>	36 (1.42)	199.8 (7.87)	162 (6.38)
<b>210 (8.27)</b>	26 (1.02)	279.8 (11.02)	242 (9.53)
<b>270 (10.63)</b>	36 (1.42)	349.8 (13.77)	312 (12.28)
<b>360 (14.17)</b>	26 (1.02)	429.8 (16.92)	392 (15.43)
<b>420 (16.54)</b>	36 (1.42)	499.8 (19.68)	462 (18.19)

- ① Detection height (DH)
- ② Indicator Power on: green; beam status: yellow
- ③ Job LED, green
- ④ Mounting hole, Ø 5.3 mm
- ⑤ Configuration switches

### Adjustments

PLG3

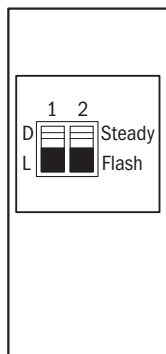

#### Configuration over switches

<b>Switch 1</b>	D	Output active, in case of blocked beams
	L	Output inactive, in case of blocked beams
<b>Switch 2</b>	Steady	Job-LED steady
	Flash	Job-LED flashes, 3 Hz

## Connection type and diagram

Connection type and diagram

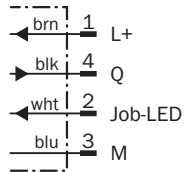
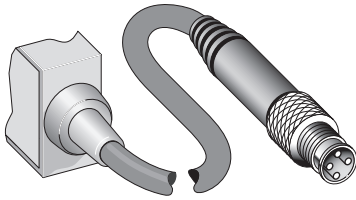

## Concept of operation

Specific features

### Easy installation

#### 1. Easy mounting on to different profiles

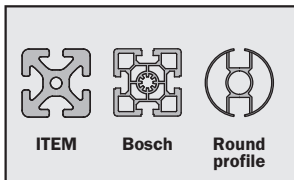

The light grid can be mounted on different profiles, e.g. ITEM, Bosch, round profile.

#### 2. Easy installation with slot nuts



The PLG can easily be mounted on the profile with slot nuts.

### Plug & play

#### 1. Plug in and tighten the ring of the connector

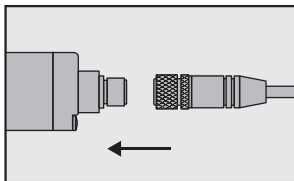

#### 2. Device is ready for use

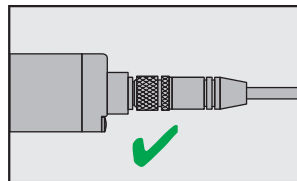

### Sensing distance

Characteristic curve: range

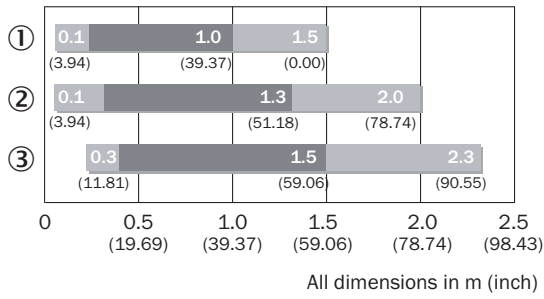

- ① REF-PLG
- ② Reflector PL150
- ③ Reflector PL180

### Detection capability

PLG3

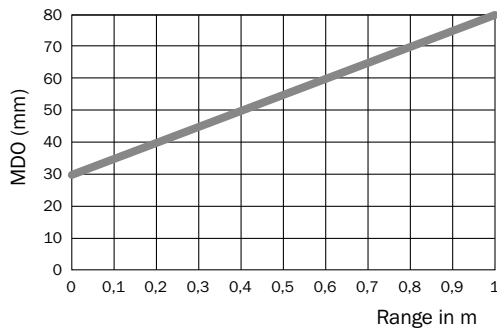



### Recommended accessories

Other models and accessories → [www.sick.com/PLG](http://www.sick.com/PLG)

	Brief description	Type	Part no.
Other mounting accessories			
	Sliding nuts with spring metal ball for ITEM profile, 2x slot 6 and slot 8, including mounting material, Mounting hardware included with every 2 x slot 6 and slot 8	BEF-NSIT-PLG	2041045

<sup>1)</sup> Customizable length by roll. Width 2.5 cm, length max. 22.8 m.

	Brief description	Type	Part no.
<b>Plug connectors and cables</b>			
	Head A: female connector, M12, 4-pin, straight, A-coded Head B: Flying leads Cable: Sensor/actuator cable, PVC, unshielded, 5 m	YF2A14-050VB3XLEAX	2096235
<b>Reflectors</b>			
	Reflective tape on aluminium profile, 2 hole mounting, Screw-on, 2 hole mounting	REF-PLG120	1029196
	Self-adhesive, customizable length by roll, 2.5 cm x 22.8 m <sup>1)</sup> , self-adhesive	REF-PLUS-R25-K	4051184

<sup>1)</sup> Customizable length by roll. Width 2.5 cm, length max. 22.8 m.

## SICK AT A GLANCE

SICK is one of the leading manufacturers of intelligent sensors and sensor solutions for industrial applications. A unique range of products and services creates the perfect basis for controlling processes securely and efficiently, protecting individuals from accidents and preventing damage to the environment.

We have extensive experience in a wide range of industries and understand their processes and requirements. With intelligent sensors, we can deliver exactly what our customers need. In application centers in Europe, Asia and North America, system solutions are tested and optimized in accordance with customer specifications. All this makes us a reliable supplier and development partner.

Comprehensive services complete our offering: SICK LifeTime Services provide support throughout the machine life cycle and ensure safety and productivity.

For us, that is “Sensor Intelligence.”

## WORLDWIDE PRESENCE:

Contacts and other locations –[www.sick.com](http://www.sick.com)