

Final datasheet

EasyPACK™ 2B module with TRENCHSTOP™ 5 H5 and CoolSiC™ Schottky diode and PressFIT / NTC

Features

- Electrical features
 - $V_{CES} = 650\text{ V}$
 - $I_{C\text{ nom}} = 40\text{ A} / I_{CRM} = 80\text{ A}$
 - CoolSiC™ Schottky diode gen 5
 - Low switching losses
 - Increased blocking voltage capability up to 650 V
 - Suitable Infineon gate drivers can be found under <https://www.infineon.com/gdfinder>
- Mechanical features
 - Rugged mounting due to integrated mounting clamps
 - AlN substrate with low thermal resistance
 - Compact design
 - PressFIT contact technology



Typical appearance

Potential applications

- Three-level applications
- UPS systems
- Solar applications
- Motor drives

Product validation

- Qualified for industrial applications according to the relevant tests of IEC 60747, 60749 and 60068

Description

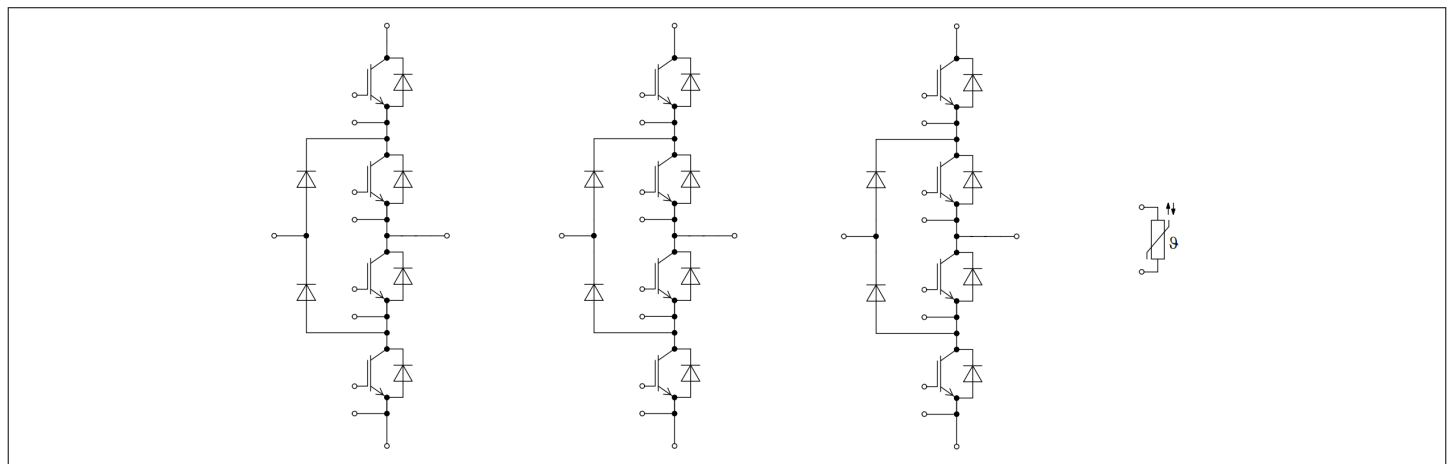

Table of contents

	Description	1
	Features	1
	Potential applications	1
	Product validation	1
	Table of contents	2
1	Package	3
2	IGBT, Inverter	3
3	Diode, Inverter	5
4	IGBT, 3-Level	6
5	Diode, 3-Level	7
6	NTC-Thermistor	8
7	Characteristics diagrams	9
8	Circuit diagram	17
9	Package outlines	18
10	Module label code	19
	Revision history	20
	Disclaimer	21

1 Package

Table 1 Insulation coordination

Parameter	Symbol	Note or test condition	Values	Unit
Isolation test voltage	V_{ISOL}	RMS, $f = 50$ Hz, $t = 60$ s	3.0	kV
Isolation test voltage NTC	$V_{ISOL(NTC)}$	RMS, $f = 50$ Hz, $t = 60$ s	3.0	kV
Internal isolation		basic insulation (class 1, IEC 61140)	AIN	
Comparative tracking index	CTI		> 200	
Relative thermal index (electrical)	RTI	housing	140	°C

Table 2 Characteristic values

Parameter	Symbol	Note or test condition	Values			Unit
			Min.	Typ.	Max.	
Stray inductance module	L_{SCE}			36		nH
Module lead resistance, terminals - chip	$R_{CC'+EE'}$	$T_H = 25$ °C, per switch		8.2		mΩ
Storage temperature	T_{stg}		-40		125	°C
Mounting force per clamp	F		40		80	N
Weight	G			42		g

Note: The current under continuous operation is limited to 25A rms per connector pin

2 IGBT, Inverter

Table 3 Maximum rated values

Parameter	Symbol	Note or test condition	Values	Unit
Collector-emitter voltage	V_{CES}	$T_{vj} = 25$ °C	650	V
Implemented collector current	I_{CN}		40	A
Continuous DC collector current	I_{CDC}	$T_{vj\ max} = 175$ °C $T_H = 115$ °C	20	A
Repetitive peak collector current	I_{CRM}	t_p limited by $T_{vj\ op}$	80	A
Gate-emitter peak voltage	V_{GES}		±20	V

Table 4 Characteristic values

Parameter	Symbol	Note or test condition		Values			Unit
				Min.	Typ.	Max.	
Collector-emitter saturation voltage	$V_{CE\ sat}$	$I_C = 20\ A, V_{GE} = 15\ V$	$T_{vj} = 25\ ^\circ C$		1.32	1.81	V
			$T_{vj} = 125\ ^\circ C$		1.39		
			$T_{vj} = 150\ ^\circ C$		1.41		
Gate threshold voltage	V_{GETh}	$I_C = 0.35\ mA, V_{CE} = V_{GE}, T_{vj} = 25\ ^\circ C$		3.85	4.60	5.35	V
Gate charge	Q_G	$V_{GE} = \pm 15\ V, V_{CC} = 300\ V$			0.152		μC
Internal gate resistor	R_{Gint}	$T_{vj} = 25\ ^\circ C$			0		Ω
Input capacitance	C_{ies}	$f = 100\ kHz, T_{vj} = 25\ ^\circ C, V_{CE} = 25\ V, V_{GE} = 0\ V$			1.94		nF
Reverse transfer capacitance	C_{res}	$f = 100\ kHz, T_{vj} = 25\ ^\circ C, V_{CE} = 25\ V, V_{GE} = 0\ V$			0.007		nF
Collector-emitter cut-off current	I_{CES}	$V_{CE} = 650\ V, V_{GE} = 0\ V$	$T_{vj} = 25\ ^\circ C$			0.018	mA
Gate-emitter leakage current	I_{GES}	$V_{CE} = 0\ V, V_{GE} = 20\ V, T_{vj} = 25\ ^\circ C$				100	nA
Turn-on delay time (inductive load)	t_{don}	$I_C = 20\ A, V_{CC} = 300\ V, V_{GE} = \pm 15\ V, R_{Gon} = 7.5\ \Omega$	$T_{vj} = 25\ ^\circ C$		0.011		μs
			$T_{vj} = 125\ ^\circ C$		0.012		
			$T_{vj} = 150\ ^\circ C$		0.012		
Rise time (inductive load)	t_r	$I_C = 20\ A, V_{CC} = 300\ V, V_{GE} = \pm 15\ V, R_{Gon} = 7.5\ \Omega$	$T_{vj} = 25\ ^\circ C$		0.009		μs
			$T_{vj} = 125\ ^\circ C$		0.014		
			$T_{vj} = 150\ ^\circ C$		0.015		
Turn-off delay time (inductive load)	t_{doff}	$I_C = 20\ A, V_{CC} = 300\ V, V_{GE} = \pm 15\ V, R_{Goff} = 7.5\ \Omega$	$T_{vj} = 25\ ^\circ C$		0.078		μs
			$T_{vj} = 125\ ^\circ C$		0.099		
			$T_{vj} = 150\ ^\circ C$		0.105		
Fall time (inductive load)	t_f	$I_C = 20\ A, V_{CC} = 300\ V, V_{GE} = \pm 15\ V, R_{Goff} = 7.5\ \Omega$	$T_{vj} = 25\ ^\circ C$		0.018		μs
			$T_{vj} = 125\ ^\circ C$		0.029		
			$T_{vj} = 150\ ^\circ C$		0.046		
Turn-on energy loss per pulse	E_{on}	$I_C = 20\ A, V_{CC} = 300\ V, L_\sigma = 35\ nH, V_{GE} = \pm 15\ V, R_{Gon} = 7.5\ \Omega, di/dt = 1100\ A/\mu s (T_{vj} = 150\ ^\circ C)$	$T_{vj} = 25\ ^\circ C$		0.17		mJ
			$T_{vj} = 125\ ^\circ C$		0.2		
			$T_{vj} = 150\ ^\circ C$		0.21		
Turn-off energy loss per pulse	E_{off}	$I_C = 20\ A, V_{CC} = 300\ V, L_\sigma = 35\ nH, V_{GE} = \pm 15\ V, R_{Goff} = 7.5\ \Omega, dv/dt = 6250\ V/\mu s (T_{vj} = 150\ ^\circ C)$	$T_{vj} = 25\ ^\circ C$		0.1		mJ
			$T_{vj} = 125\ ^\circ C$		0.2		
			$T_{vj} = 150\ ^\circ C$		0.22		
Thermal resistance, junction to heat sink	R_{thJH}	per IGBT, $\lambda_{grease} = 1\ W/(m \cdot K)$			1.36		K/W

(table continues...)

Table 4 (continued) Characteristic values

Parameter	Symbol	Note or test condition	Values			Unit
			Min.	Typ.	Max.	
Temperature under switching conditions	$T_{vj\ op}$		-40		150	°C

3 Diode, Inverter

Table 5 Maximum rated values

Parameter	Symbol	Note or test condition	Values	Unit	
Repetitive peak reverse voltage	V_{RRM}	$T_{vj} = 25\ ^\circ\text{C}$	650	V	
Implemented forward current	I_{FN}		25	A	
Continuous DC forward current	I_F		20	A	
Repetitive peak forward current	I_{FRM}	$t_p = 1\ \text{ms}$	50	A	
I^2t - value	I^2t	$t_p = 10\ \text{ms}, V_R = 0\ \text{V}$	$T_{vj} = 125\ ^\circ\text{C}$	55	A ² s
			$T_{vj} = 150\ ^\circ\text{C}$	50	

Table 6 Characteristic values

Parameter	Symbol	Note or test condition	Values			Unit	
			Min.	Typ.	Max.		
Forward voltage	V_F	$I_F = 20\ \text{A}, V_{GE} = 0\ \text{V}$	$T_{vj} = 25\ ^\circ\text{C}$		1.65	2.15	V
			$T_{vj} = 125\ ^\circ\text{C}$		1.55		
			$T_{vj} = 150\ ^\circ\text{C}$		1.50		
Peak reverse recovery current	I_{RM}	$V_{CC} = 300\ \text{V}, I_F = 20\ \text{A}, V_{GE} = -15\ \text{V}, -di_F/dt = 1100\ \text{A}/\mu\text{s} (T_{vj} = 150\ ^\circ\text{C})$	$T_{vj} = 25\ ^\circ\text{C}$		14		A
			$T_{vj} = 125\ ^\circ\text{C}$		18		
			$T_{vj} = 150\ ^\circ\text{C}$		20		
Recovered charge	Q_r	$V_{CC} = 300\ \text{V}, I_F = 20\ \text{A}, V_{GE} = -15\ \text{V}, -di_F/dt = 1100\ \text{A}/\mu\text{s} (T_{vj} = 150\ ^\circ\text{C})$	$T_{vj} = 25\ ^\circ\text{C}$		0.77		μC
			$T_{vj} = 125\ ^\circ\text{C}$		1.2		
			$T_{vj} = 150\ ^\circ\text{C}$		1.44		
Reverse recovery energy	E_{rec}	$V_{CC} = 300\ \text{V}, I_F = 20\ \text{A}, V_{GE} = -15\ \text{V}, -di_F/dt = 1100\ \text{A}/\mu\text{s} (T_{vj} = 150\ ^\circ\text{C})$	$T_{vj} = 25\ ^\circ\text{C}$		0.16		mJ
			$T_{vj} = 125\ ^\circ\text{C}$		0.22		
			$T_{vj} = 150\ ^\circ\text{C}$		0.27		
Thermal resistance, junction to heat sink	R_{thJH}	per diode, $\lambda_{grease} = 1\ \text{W}/(\text{m}\cdot\text{K})$		1.78		K/W	

(table continues...)

Table 6 (continued) Characteristic values

Parameter	Symbol	Note or test condition	Values			Unit
			Min.	Typ.	Max.	
Temperature under switching conditions	$T_{vj\ op}$		-40		150	°C

4 IGBT, 3-Level

Table 7 Maximum rated values

Parameter	Symbol	Note or test condition	Values	Unit
Collector-emitter voltage	V_{CES}	$T_{vj} = 25\ ^\circ\text{C}$	650	V
Implemented collector current	I_{CN}		40	A
Continuous DC collector current	I_{CDC}	$T_{vj\ max} = 175\ ^\circ\text{C}$ $T_H = 115\ ^\circ\text{C}$	20	A
Repetitive peak collector current	I_{CRM}	t_p limited by $T_{vj\ op}$	80	A
Gate-emitter peak voltage	V_{GES}		±20	V

Table 8 Characteristic values

Parameter	Symbol	Note or test condition	Values			Unit
			Min.	Typ.	Max.	
Collector-emitter saturation voltage	$V_{CE\ sat}$	$I_C = 20\ \text{A}, V_{GE} = 15\ \text{V}$	$T_{vj} = 25\ ^\circ\text{C}$	1.32	1.81	V
			$T_{vj} = 125\ ^\circ\text{C}$	1.39		
			$T_{vj} = 150\ ^\circ\text{C}$	1.41		
Gate threshold voltage	V_{GEth}	$I_C = 0.35\ \text{mA}, V_{CE} = V_{GE}, T_{vj} = 25\ ^\circ\text{C}$	3.85	4.60	5.35	V
Gate charge	Q_G	$V_{GE} = \pm 15\ \text{V}, V_{CC} = 300\ \text{V}$		0.152		μC
Internal gate resistor	R_{Gint}	$T_{vj} = 25\ ^\circ\text{C}$		0		Ω
Input capacitance	C_{ies}	$f = 100\ \text{kHz}, T_{vj} = 25\ ^\circ\text{C}, V_{CE} = 25\ \text{V}, V_{GE} = 0\ \text{V}$		1.94		nF
Reverse transfer capacitance	C_{res}	$f = 100\ \text{kHz}, T_{vj} = 25\ ^\circ\text{C}, V_{CE} = 25\ \text{V}, V_{GE} = 0\ \text{V}$		0.007		nF
Collector-emitter cut-off current	I_{CES}	$V_{CE} = 650\ \text{V}, V_{GE} = 0\ \text{V}$ $T_{vj} = 25\ ^\circ\text{C}$			0.018	mA
Gate-emitter leakage current	I_{GES}	$V_{CE} = 0\ \text{V}, V_{GE} = 20\ \text{V}, T_{vj} = 25\ ^\circ\text{C}$			100	nA
Turn-on delay time (inductive load)	t_{don}	$I_C = 20\ \text{A}, V_{CC} = 300\ \text{V}, V_{GE} = \pm 15\ \text{V}, R_{Gon} = 3.9\ \Omega$	$T_{vj} = 25\ ^\circ\text{C}$	0.011		μs
			$T_{vj} = 125\ ^\circ\text{C}$	0.012		
			$T_{vj} = 150\ ^\circ\text{C}$	0.012		

(table continues...)

Table 8 (continued) Characteristic values

Parameter	Symbol	Note or test condition	Values			Unit
			Min.	Typ.	Max.	
Rise time (inductive load)	t_r	$I_C = 20\text{ A}, V_{CC} = 300\text{ V}, V_{GE} = \pm 15\text{ V}, R_{Gon} = 3.9\ \Omega$	$T_{vj} = 25\text{ }^\circ\text{C}$	0.005		μs
			$T_{vj} = 125\text{ }^\circ\text{C}$	0.006		
			$T_{vj} = 150\text{ }^\circ\text{C}$	0.006		
Turn-off delay time (inductive load)	t_{doff}	$I_C = 20\text{ A}, V_{CC} = 300\text{ V}, V_{GE} = \pm 15\text{ V}, R_{Goff} = 3.9\ \Omega$	$T_{vj} = 25\text{ }^\circ\text{C}$	0.069		μs
			$T_{vj} = 125\text{ }^\circ\text{C}$	0.085		
			$T_{vj} = 150\text{ }^\circ\text{C}$	0.091		
Fall time (inductive load)	t_f	$I_C = 20\text{ A}, V_{CC} = 300\text{ V}, V_{GE} = \pm 15\text{ V}, R_{Goff} = 3.9\ \Omega$	$T_{vj} = 25\text{ }^\circ\text{C}$	0.021		μs
			$T_{vj} = 125\text{ }^\circ\text{C}$	0.052		
			$T_{vj} = 150\text{ }^\circ\text{C}$	0.065		
Turn-on energy loss per pulse	E_{on}	$I_C = 20\text{ A}, V_{CC} = 300\text{ V}, L_\sigma = 35\text{ nH}, V_{GE} = \pm 15\text{ V}, R_{Gon} = 3.9\ \Omega, di/dt = 3500\text{ A}/\mu\text{s} (T_{vj} = 150\text{ }^\circ\text{C})$	$T_{vj} = 25\text{ }^\circ\text{C}$	0.08		mJ
			$T_{vj} = 125\text{ }^\circ\text{C}$	0.09		
			$T_{vj} = 150\text{ }^\circ\text{C}$	0.09		
Turn-off energy loss per pulse	E_{off}	$I_C = 20\text{ A}, V_{CC} = 300\text{ V}, L_\sigma = 35\text{ nH}, V_{GE} = \pm 15\text{ V}, R_{Goff} = 3.9\ \Omega, dv/dt = 6210\text{ V}/\mu\text{s} (T_{vj} = 150\text{ }^\circ\text{C})$	$T_{vj} = 25\text{ }^\circ\text{C}$	0.11		mJ
			$T_{vj} = 125\text{ }^\circ\text{C}$	0.19		
			$T_{vj} = 150\text{ }^\circ\text{C}$	0.21		
Thermal resistance, junction to heat sink	R_{thJH}	per IGBT, $\lambda_{grease} = 1\text{ W}/(\text{m}\cdot\text{K})$		1.36		K/W
Temperature under switching conditions	$T_{vj\text{ op}}$		-40		150	$^\circ\text{C}$

5 Diode, 3-Level

Table 9 Maximum rated values

Parameter	Symbol	Note or test condition	Values	Unit	
Repetitive peak reverse voltage	V_{RRM}	$T_{vj} = 25\text{ }^\circ\text{C}$	650	V	
Continuous DC forward current	I_F		20	A	
Repetitive peak forward current	I_{FRM}	$t_p = 1\text{ ms}$	40	A	
I^2t - value	I^2t	$t_p = 10\text{ ms}, V_R = 0\text{ V}$	$T_{vj} = 125\text{ }^\circ\text{C}$	65	A^2s
			$T_{vj} = 150\text{ }^\circ\text{C}$	65	

Table 10 Characteristic values

Parameter	Symbol	Note or test condition	Values			Unit	
			Min.	Typ.	Max.		
Forward voltage	V_F	$I_F = 20 \text{ A}, V_{GE} = 0 \text{ V}$	$T_{vj} = 25 \text{ °C}$		1.45	1.85	V
			$T_{vj} = 125 \text{ °C}$		1.60		
			$T_{vj} = 150 \text{ °C}$		1.65		
Peak reverse recovery current	I_{RM}	$V_{CC} = 300 \text{ V}, I_F = 20 \text{ A}, V_{GE} = 15 \text{ V}, -di_F/dt = 3500 \text{ A}/\mu\text{s} (T_{vj} = 150 \text{ °C})$	$T_{vj} = 25 \text{ °C}$		19		A
			$T_{vj} = 125 \text{ °C}$		17		
			$T_{vj} = 150 \text{ °C}$		16		
Recovered charge	Q_r	$V_{CC} = 300 \text{ V}, I_F = 20 \text{ A}, V_{GE} = 15 \text{ V}, -di_F/dt = 3500 \text{ A}/\mu\text{s} (T_{vj} = 150 \text{ °C})$	$T_{vj} = 25 \text{ °C}$		0.13		μC
			$T_{vj} = 125 \text{ °C}$		0.12		
			$T_{vj} = 150 \text{ °C}$		0.12		
Reverse recovery energy	E_{rec}	$V_{CC} = 300 \text{ V}, I_F = 20 \text{ A}, V_{GE} = 15 \text{ V}, -di_F/dt = 3500 \text{ A}/\mu\text{s} (T_{vj} = 150 \text{ °C})$	$T_{vj} = 25 \text{ °C}$		0.015		mJ
			$T_{vj} = 125 \text{ °C}$		0.015		
			$T_{vj} = 150 \text{ °C}$		0.015		
Thermal resistance, junction to heat sink	R_{thJH}	per diode, $\lambda_{grease} = 1 \text{ W}/(\text{m}\cdot\text{K})$			1.92		K/W
Temperature under switching conditions	$T_{vj\text{ op}}$			-40		150	$^{\circ}\text{C}$

6 NTC-Thermistor

Table 11 Characteristic values

Parameter	Symbol	Note or test condition	Values			Unit
			Min.	Typ.	Max.	
Rated resistance	R_{25}	$T_{NTC} = 25 \text{ °C}$		5		k Ω
Deviation of R_{100}	$\Delta R/R$	$T_{NTC} = 100 \text{ °C}, R_{100} = 493 \text{ }\Omega$	-5		5	%
Power dissipation	P_{25}	$T_{NTC} = 25 \text{ °C}$			20	mW
B-value	$B_{25/50}$	$R_2 = R_{25} \exp[B_{25/50}(1/T_2 - 1/(298,15 \text{ K}))]$		3375		K
B-value	$B_{25/80}$	$R_2 = R_{25} \exp[B_{25/80}(1/T_2 - 1/(298,15 \text{ K}))]$		3411		K
B-value	$B_{25/100}$	$R_2 = R_{25} \exp[B_{25/100}(1/T_2 - 1/(298,15 \text{ K}))]$		3433		K

Note: For an analytical description of the NTC characteristics please refer to AN2009-10, chapter 4.

7 Characteristics diagrams

Output characteristic (typical), IGBT, Inverter

$I_C = f(V_{CE})$
 $V_{GE} = 15\text{ V}$

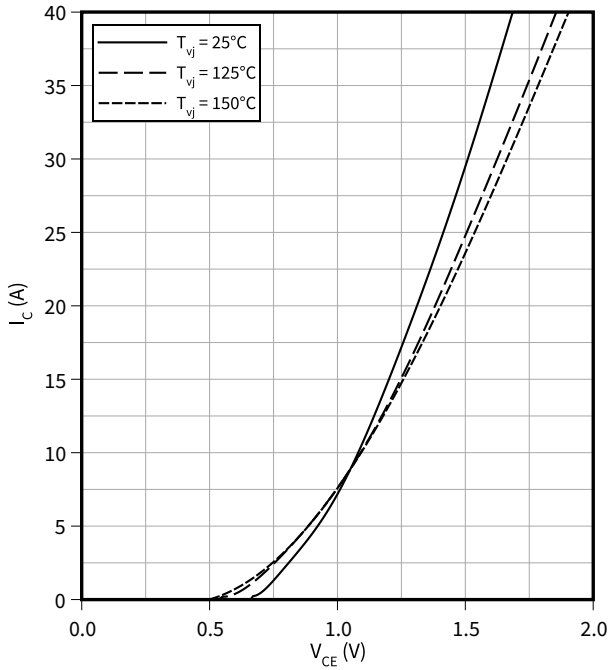

Output characteristic field (typical), IGBT, Inverter

$I_C = f(V_{CE})$
 $T_{vj} = 150\text{ °C}$

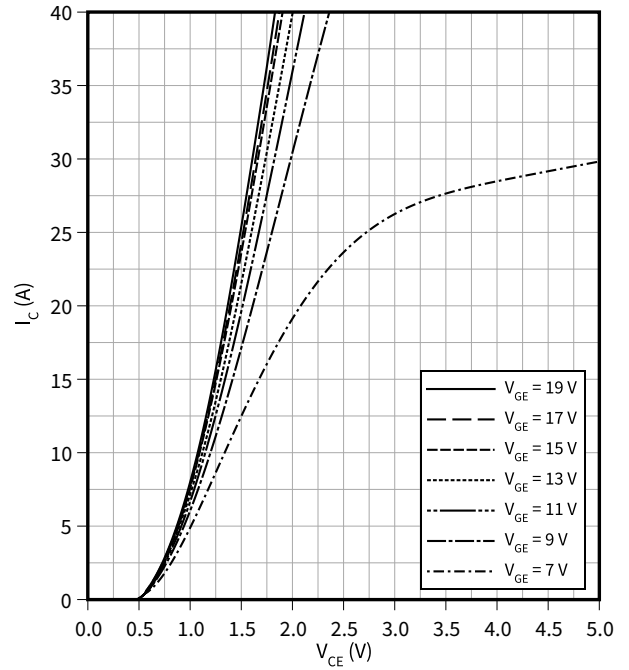

Transfer characteristic (typical), IGBT, Inverter

$I_C = f(V_{GE})$
 $V_{CE} = 20\text{ V}$

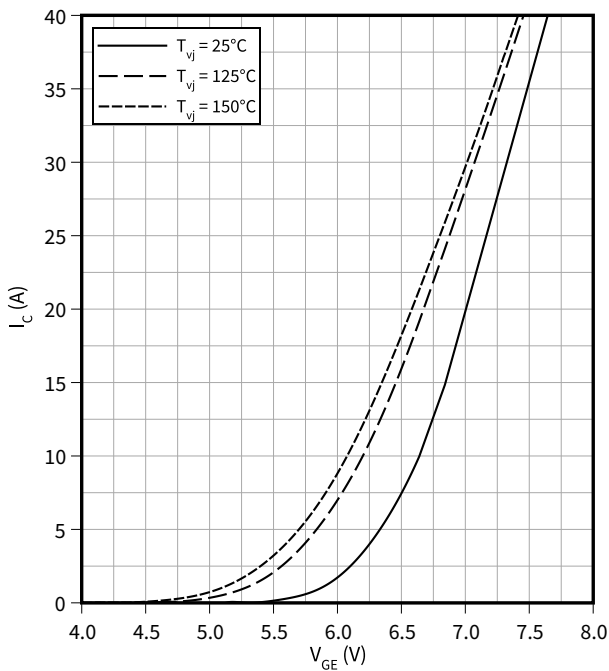

Gate charge characteristic (typical), IGBT, Inverter

$V_{GE} = f(Q_G)$
 $I_C = 20\text{ A}, T_{vj} = 25\text{ °C}$

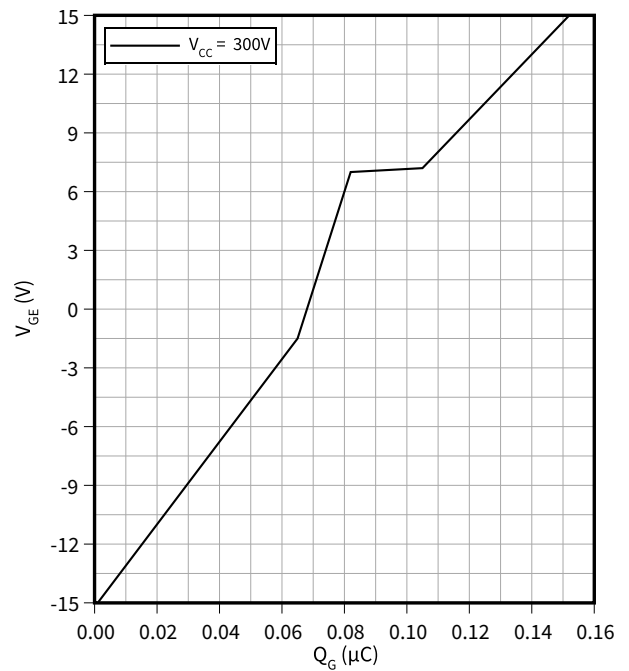

7 Characteristics diagrams

Capacity characteristic (typical), IGBT, Inverter

$C = f(V_{CE})$

$f = 100 \text{ kHz}, V_{GE} = 0 \text{ V}, T_{vj} = 25 \text{ }^\circ\text{C}$

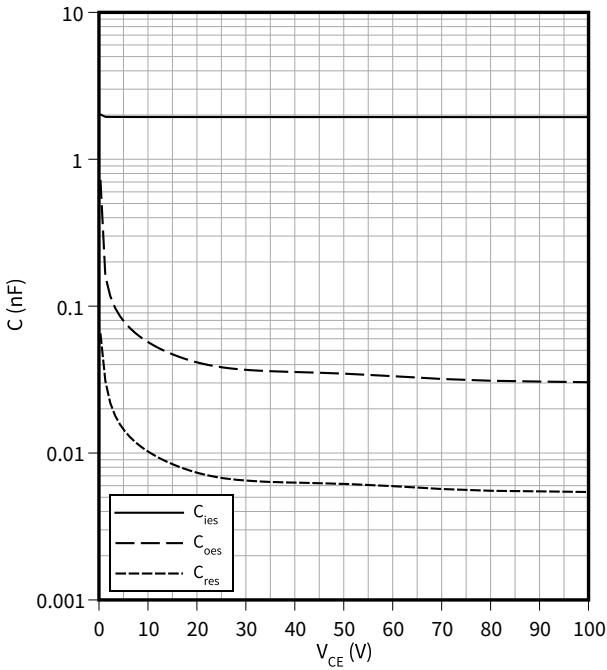

Switching times (typical), IGBT, Inverter

$t = f(I_C)$

$R_{Goff} = 7.5 \text{ } \Omega, R_{Gon} = 7.5 \text{ } \Omega, V_{CC} = 300 \text{ V}, V_{GE} = -15 / 15 \text{ V}, T_{vj} = 150 \text{ }^\circ\text{C}$

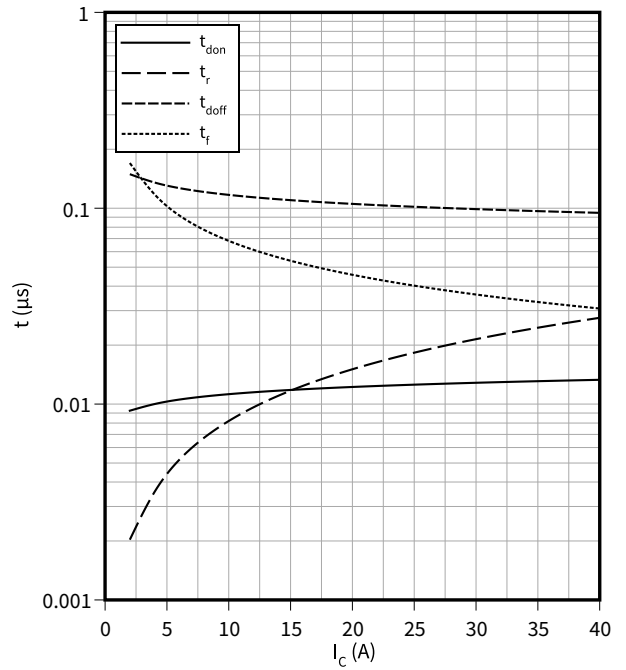

Switching times (typical), IGBT, Inverter

$t = f(R_G)$

$I_C = 20 \text{ A}, V_{CC} = 300 \text{ V}, V_{GE} = -15 / 15 \text{ V}, T_{vj} = 150 \text{ }^\circ\text{C}$

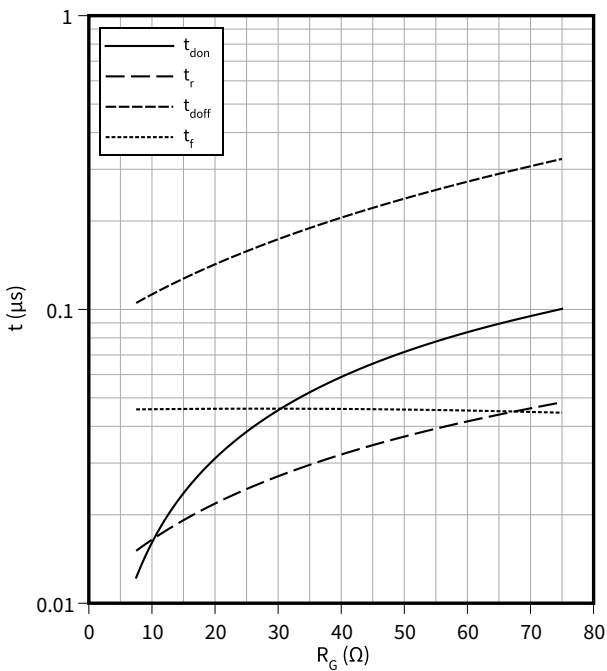

Switching losses (typical), IGBT, Inverter

$E = f(I_C)$

$R_{Goff} = 7.5 \text{ } \Omega, R_{Gon} = 7.5 \text{ } \Omega, V_{CC} = 300 \text{ V}, V_{GE} = -15 / 15 \text{ V}$

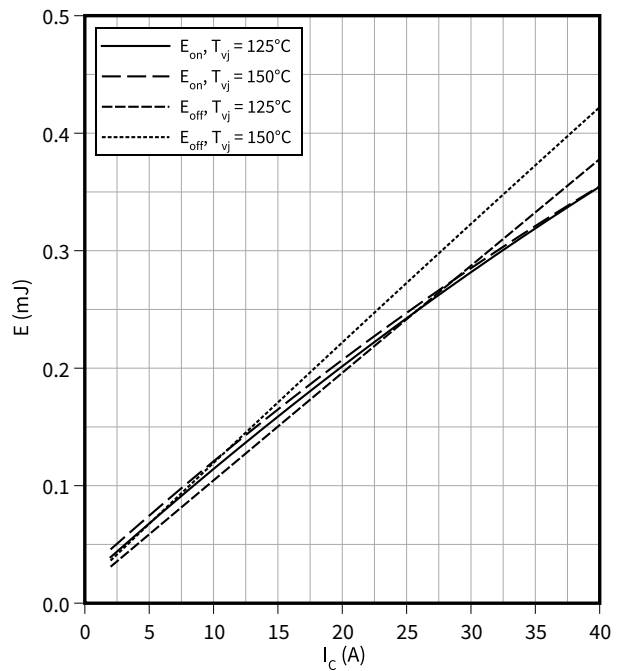

7 Characteristics diagrams

Switching losses (typical), IGBT, Inverter

$E = f(R_G)$

$I_C = 20\text{ A}, V_{CC} = 300\text{ V}, V_{GE} = -15 / 15\text{ V}$

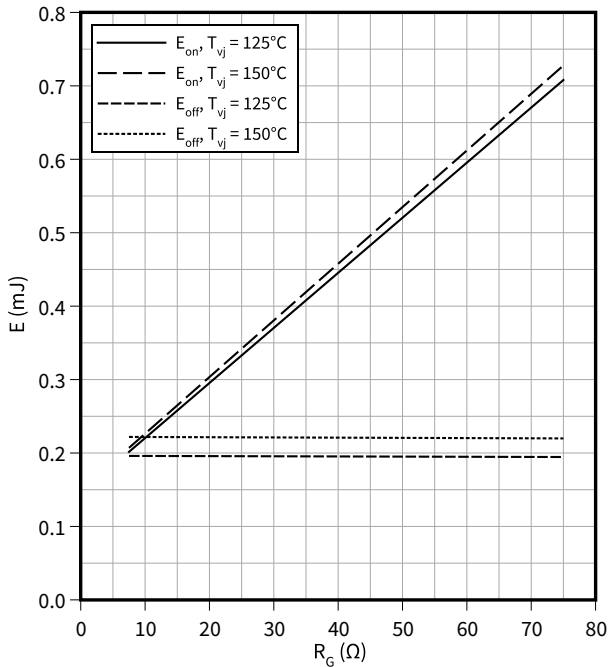

Reverse bias safe operating area (RBSOA), IGBT, Inverter

$I_C = f(V_{CE})$

$R_{Goff} = 7.5\ \Omega, V_{GE} = \pm 15\text{ V}, T_{vj} = 150\text{ °C}$

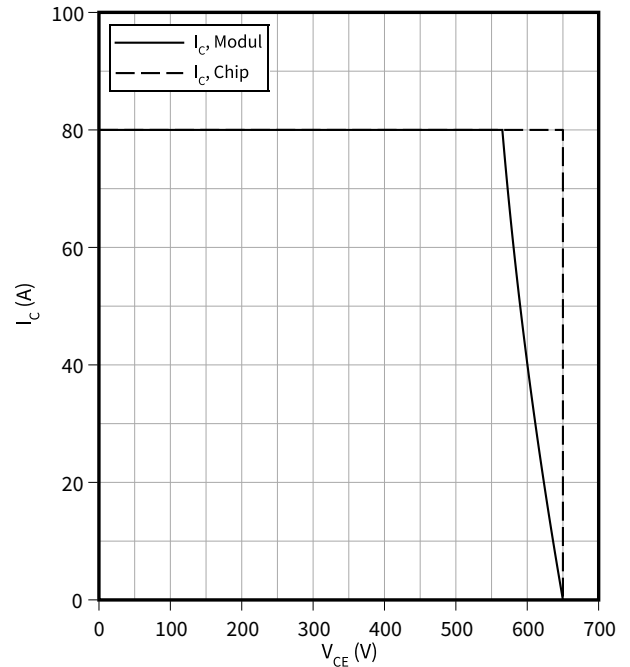

Transient thermal impedance, IGBT, Inverter

$Z_{th} = f(t)$

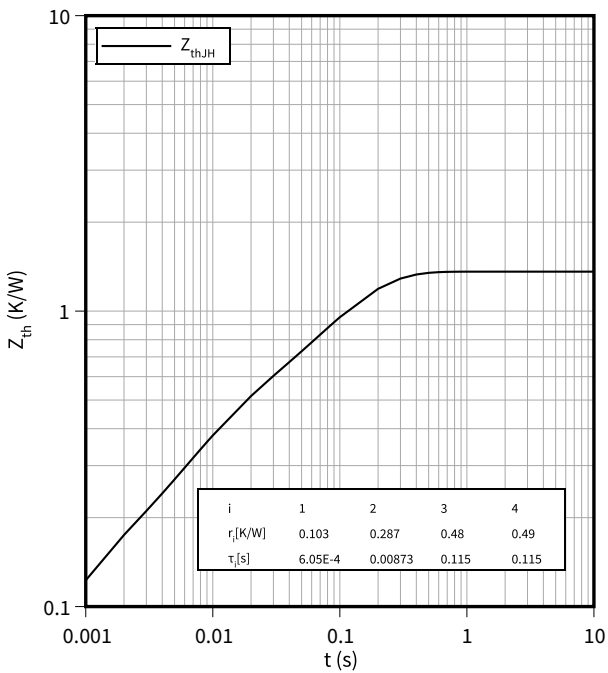

Forward characteristic (typical), Diode, Inverter

$I_F = f(V_F)$

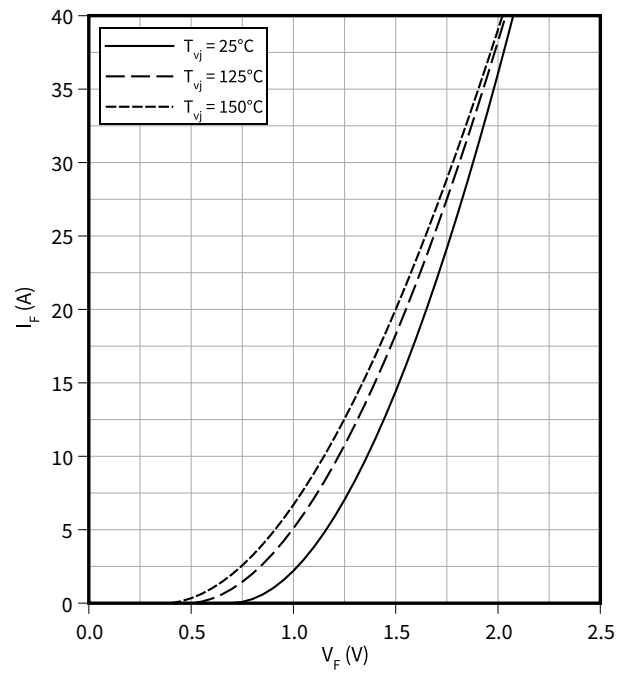

7 Characteristics diagrams

Switching losses (typical), Diode, Inverter

$E_{rec} = f(I_F)$
 $R_{Gon} = 7.5 \Omega, V_{CE} = 300 V$

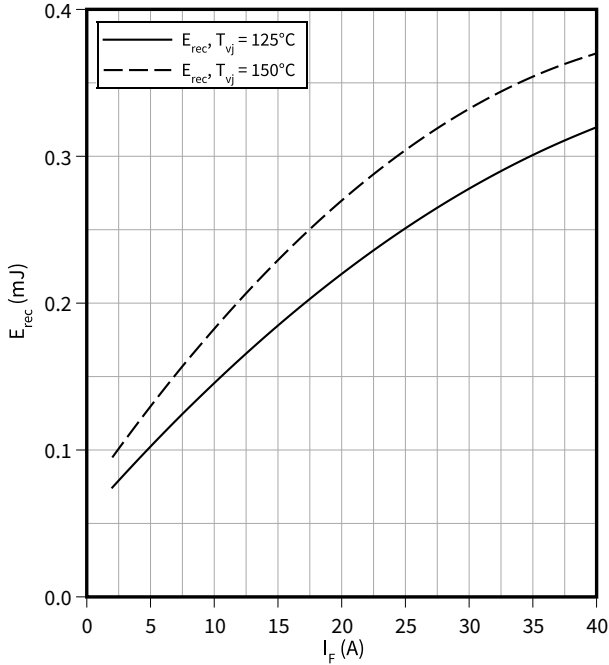

Switching losses (typical), Diode, Inverter

$E_{rec} = f(R_G)$
 $V_{CE} = 300 V, I_F = 20 A$

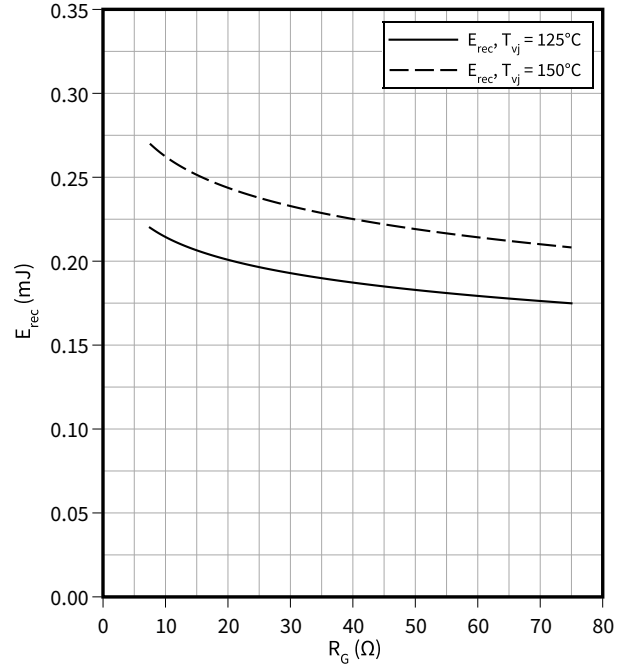

Transient thermal impedance, Diode, Inverter

$Z_{th} = f(t)$

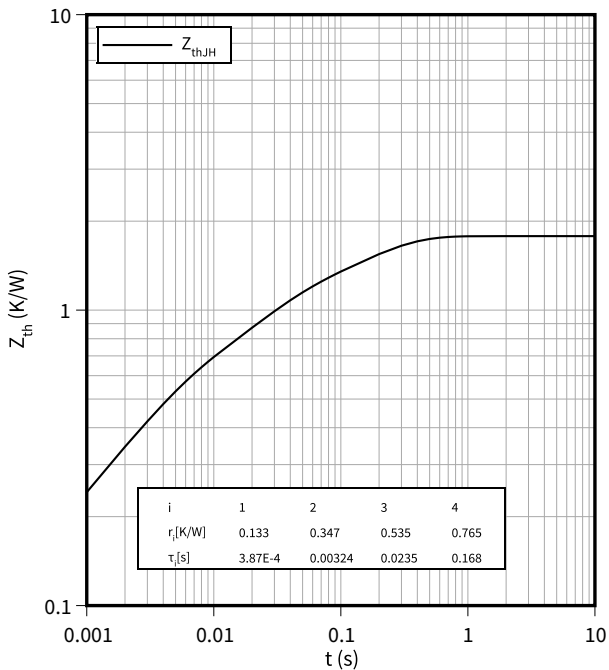

Output characteristic (typical), IGBT, 3-Level

$I_C = f(V_{CE})$
 $V_{GE} = 15 V$

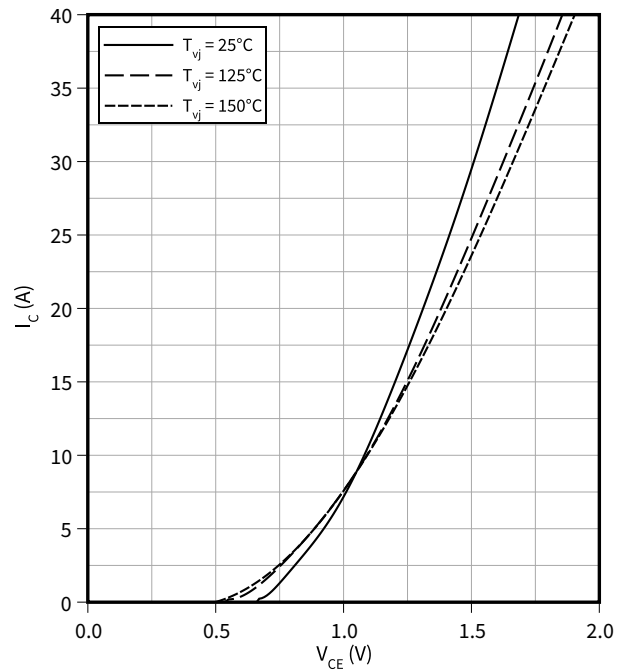

7 Characteristics diagrams

Output characteristic field (typical), IGBT, 3-Level

$I_C = f(V_{CE})$
 $T_{vj} = 150\text{ °C}$

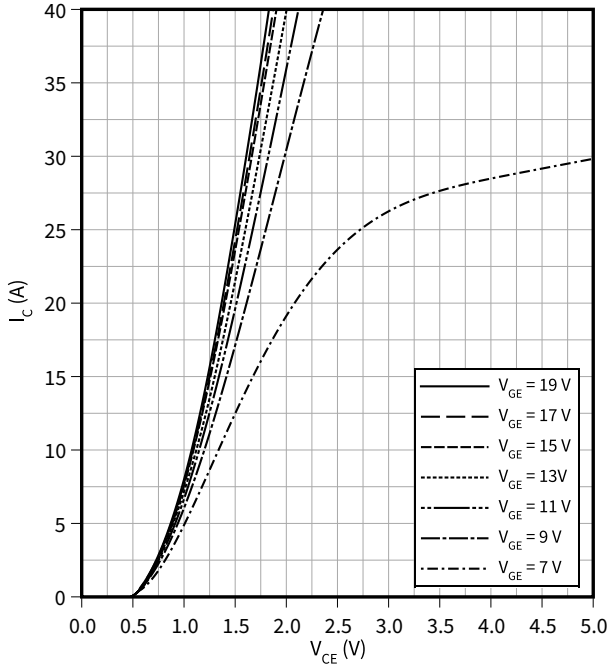

Transfer characteristic (typical), IGBT, 3-Level

$I_C = f(V_{GE})$
 $V_{CE} = 20\text{ V}$

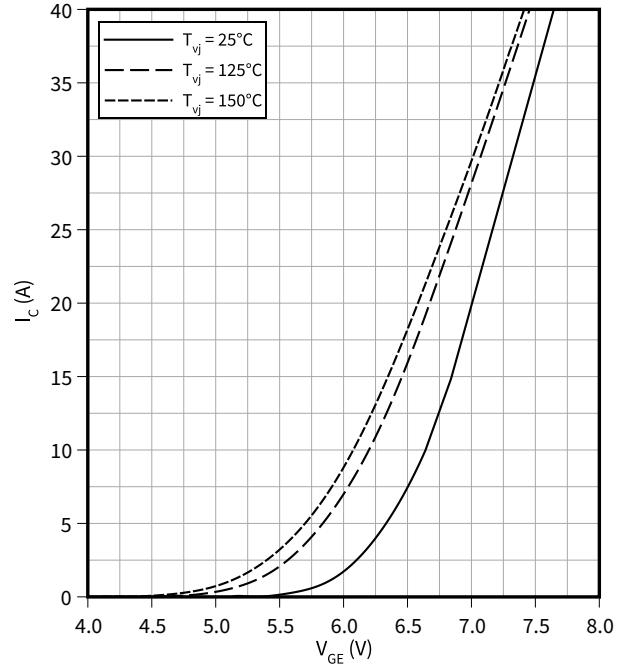

Gate charge characteristic (typical), IGBT, 3-Level

$V_{GE} = f(Q_G)$
 $I_C = 20\text{ A}, T_{vj} = 25\text{ °C}$

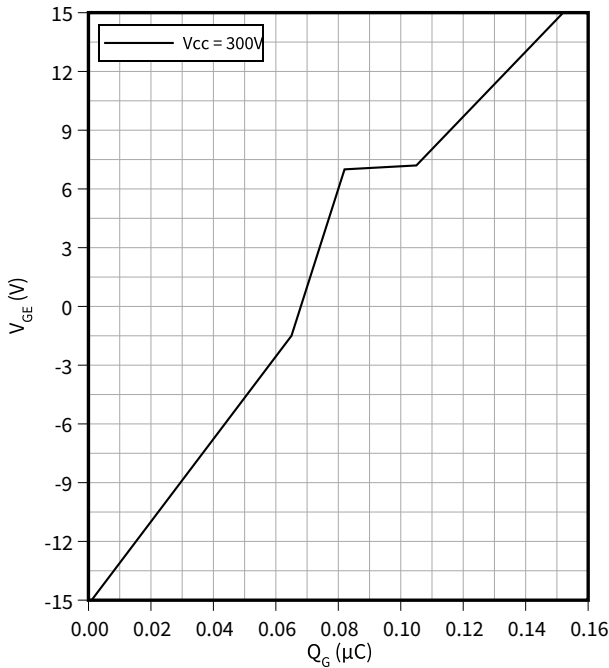

Capacity characteristic (typical), IGBT, 3-Level

$C = f(V_{CE})$
 $f = 100\text{ kHz}, V_{GE} = 0\text{ V}, T_{vj} = 25\text{ °C}$

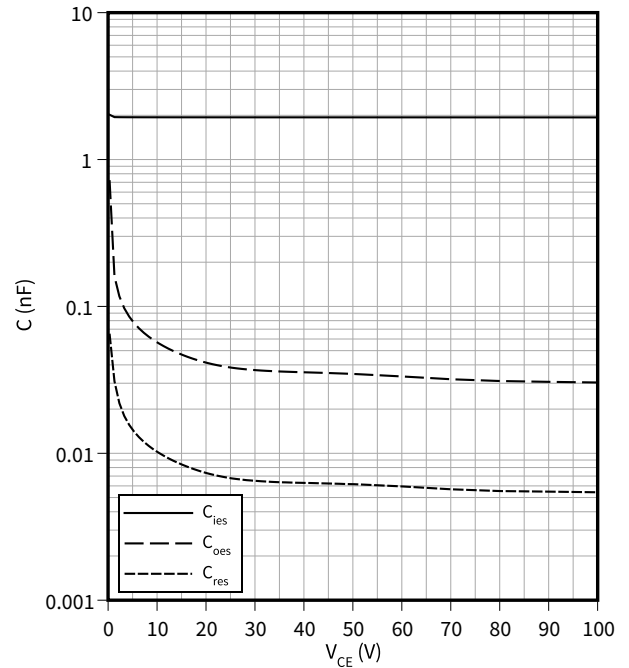

7 Characteristics diagrams

Switching times (typical), IGBT, 3-Level

$t = f(I_C)$

$R_{Goff} = 3.9 \Omega$, $R_{Gon} = 3.9 \Omega$, $V_{CC} = 300 \text{ V}$, $V_{GE} = -15 / 15 \text{ V}$, $T_{vj} = 150 \text{ }^\circ\text{C}$

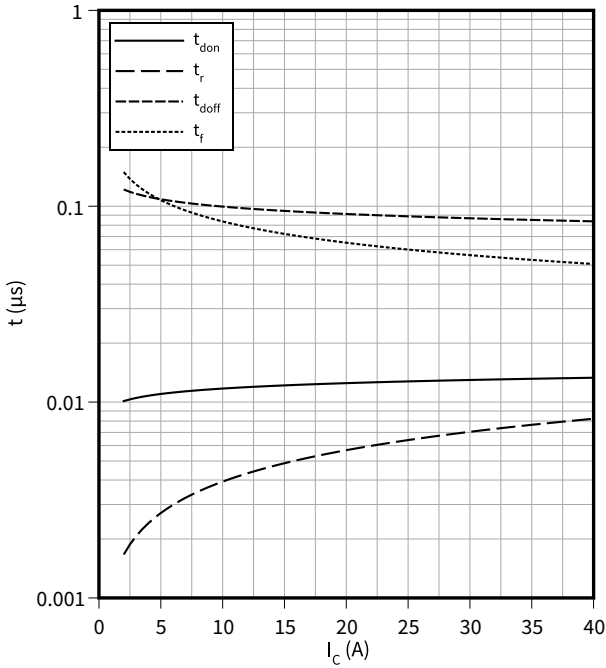

Switching times (typical), IGBT, 3-Level

$t = f(R_G)$

$I_C = 20 \text{ A}$, $V_{CC} = 300 \text{ V}$, $V_{GE} = -15 / 15 \text{ V}$, $T_{vj} = 150 \text{ }^\circ\text{C}$

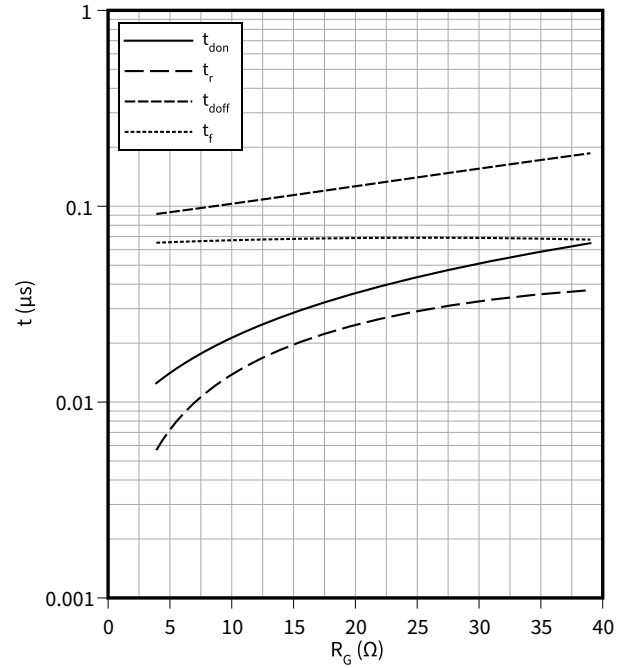

Switching losses (typical), IGBT, 3-Level

$E = f(I_C)$

$R_{Goff} = 3.9 \Omega$, $R_{Gon} = 3.9 \Omega$, $V_{CC} = 300 \text{ V}$, $V_{GE} = -15 / 15 \text{ V}$

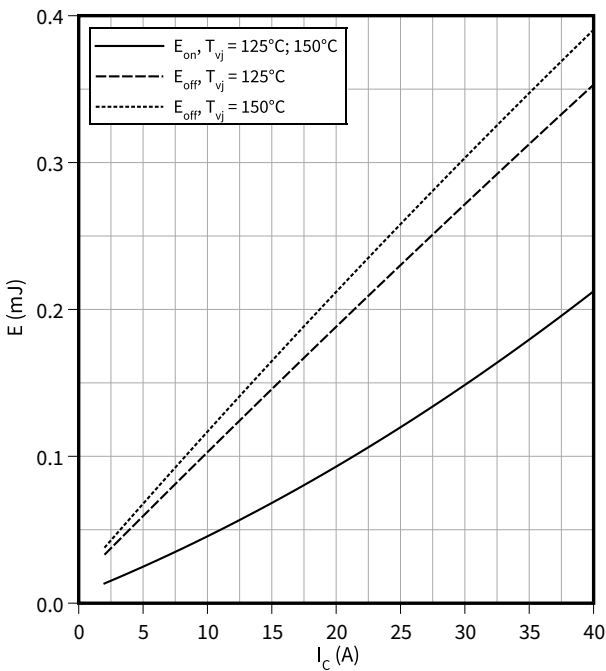

Switching losses (typical), IGBT, 3-Level

$E = f(R_G)$

$I_C = 20 \text{ A}$, $V_{CC} = 300 \text{ V}$, $V_{GE} = -15 / 15 \text{ V}$

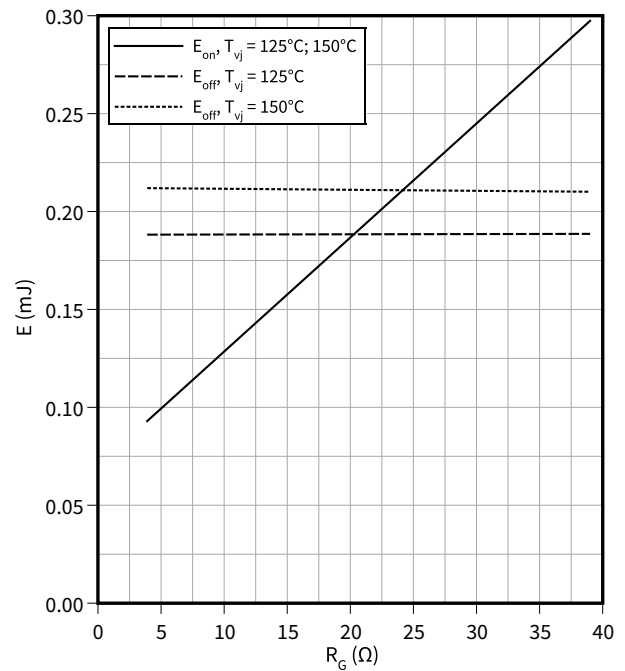

7 Characteristics diagrams

Reverse bias safe operating area (RBSOA), IGBT, 3-Level

$I_C = f(V_{CE})$

$R_{Goff} = 3.9 \Omega$, $V_{GE} = \pm 15 V$, $T_{vj} = 150 \text{ }^\circ\text{C}$

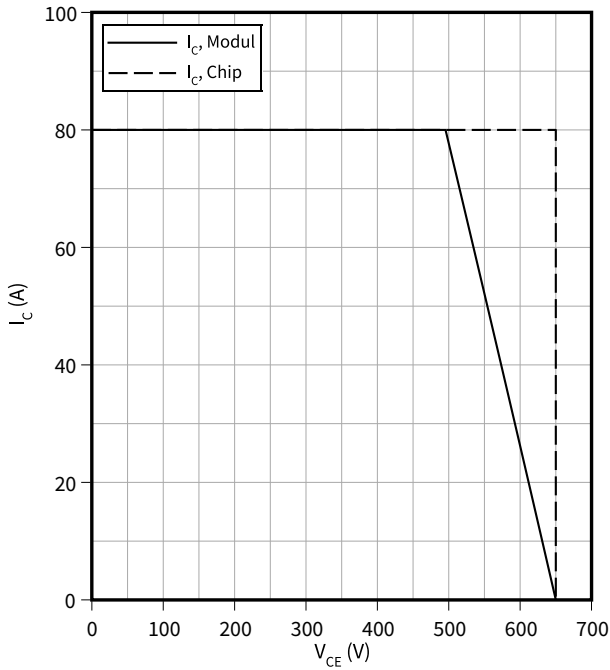

Transient thermal impedance, IGBT, 3-Level

$Z_{th} = f(t)$

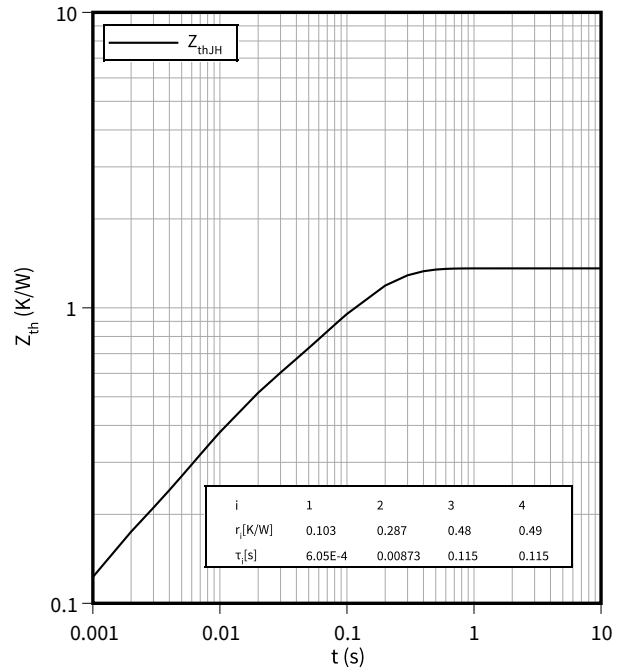

Forward characteristic (typical), Diode, 3-Level

$I_F = f(V_F)$

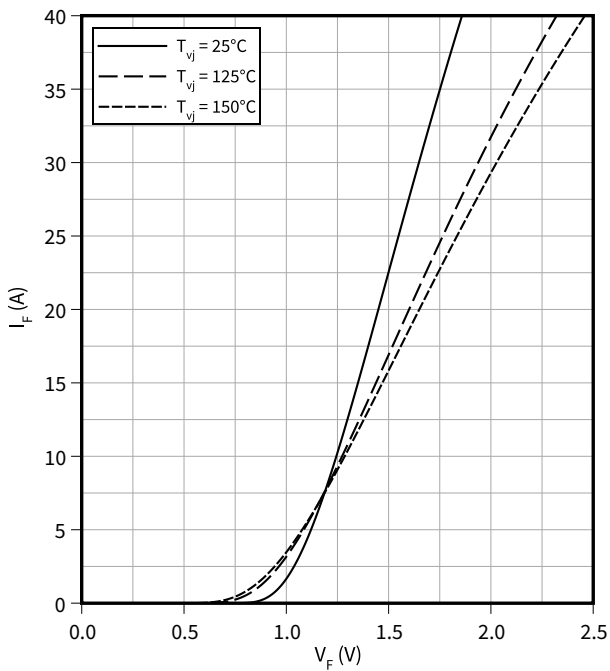

Switching losses (typical), Diode, 3-Level

$E_{rec} = f(I_F)$

$R_{Gon} = 3.9 \Omega$, $V_{CE} = 300 V$

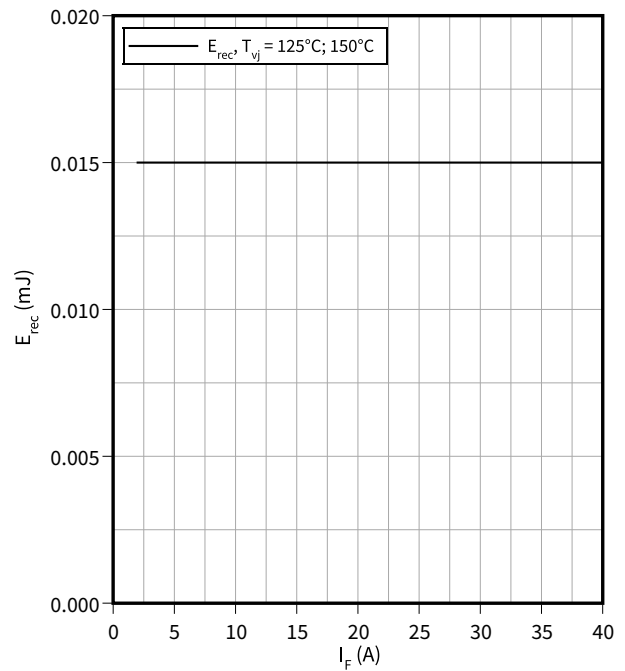

7 Characteristics diagrams

Switching losses (typical), Diode, 3-Level

$E_{rec} = f(R_G)$

$V_{CE} = 300\text{ V}, I_F = 20\text{ A}$

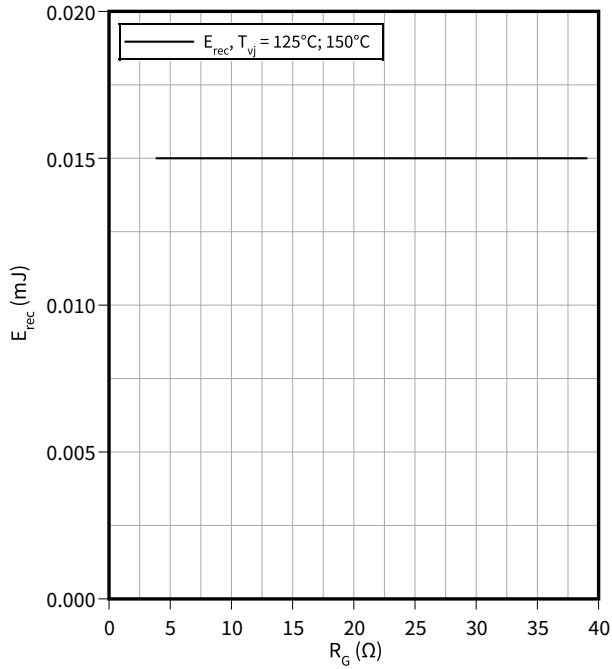

Transient thermal impedance, Diode, 3-Level

$Z_{th} = f(t)$

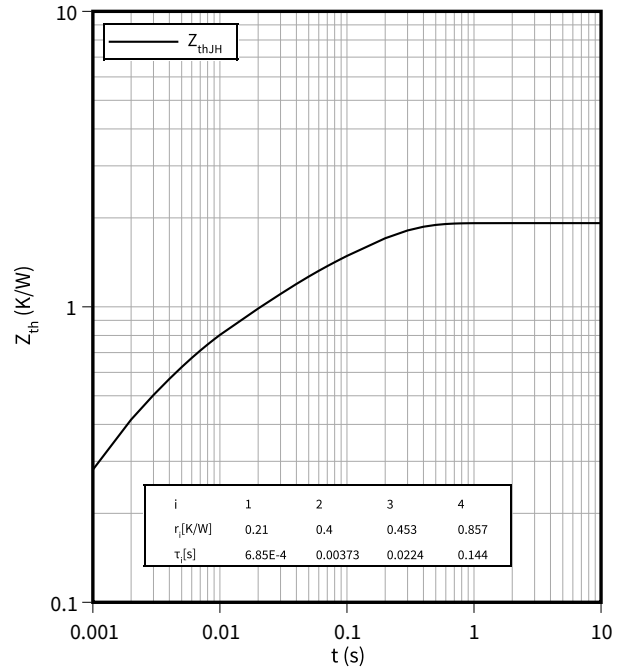

Temperature characteristic (typical), NTC-Thermistor

$R = f(T_{NTC})$

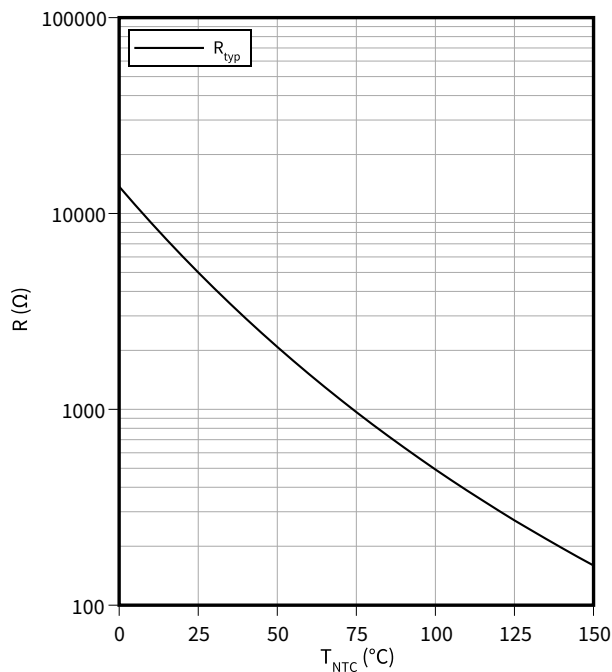

8 Circuit diagram

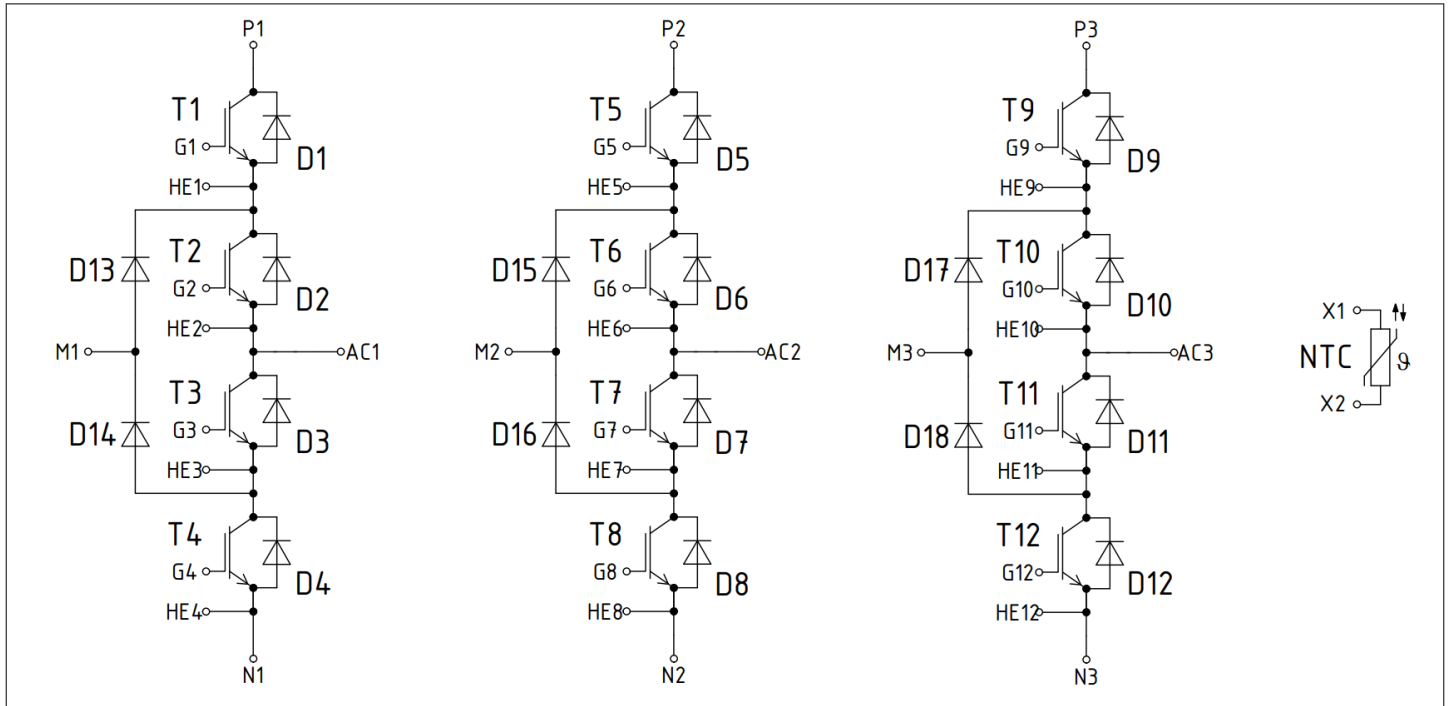

Figure 1

9 Package outlines

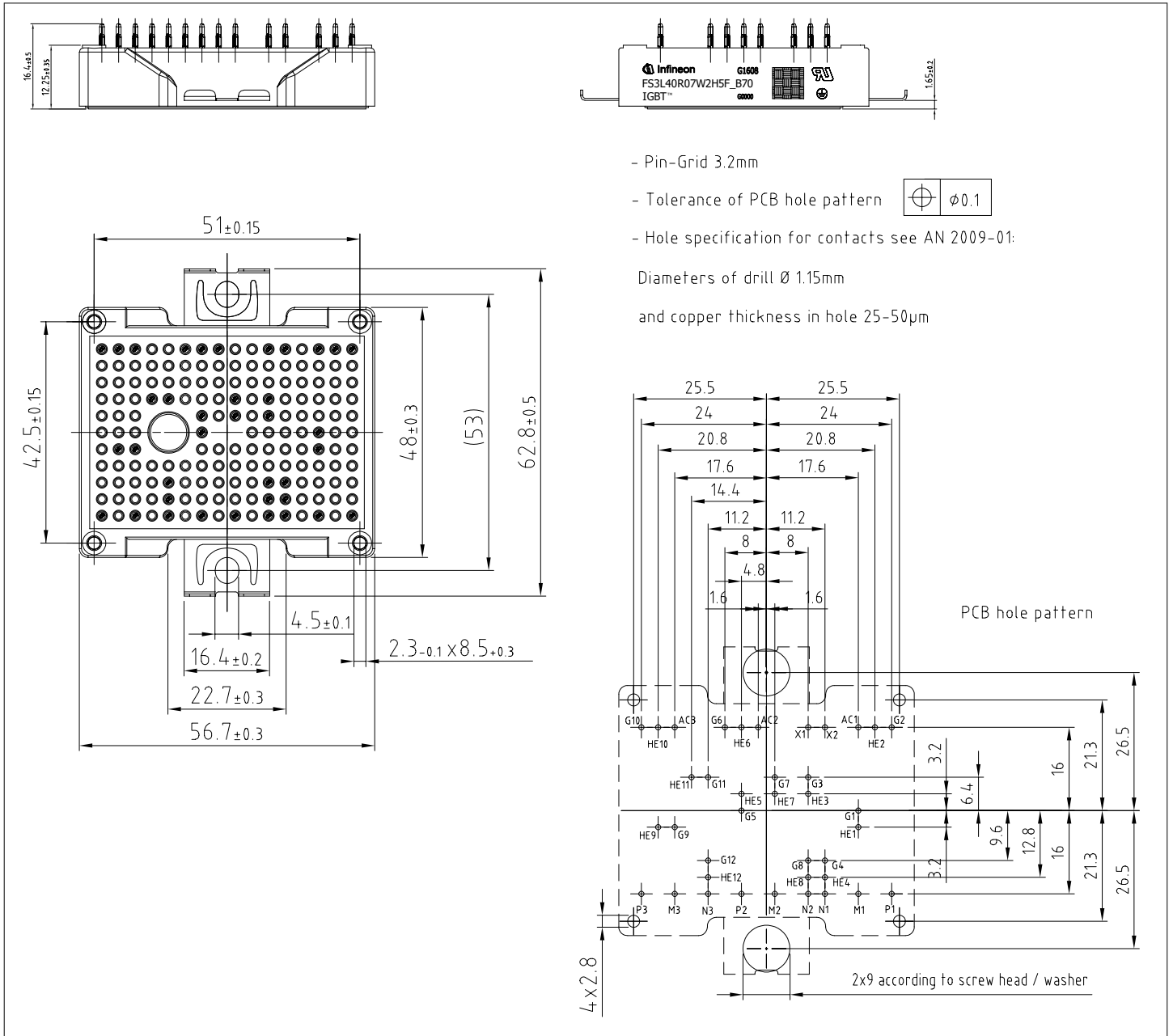

Figure 2

10 Module label code

Module label code			
Code format	Data Matrix	Barcode Code128	
Encoding	ASCII text	Code Set A	
Symbol size	16x16	23 digits	
Standard	IEC24720 and IEC16022	IEC8859-1	
Code content	<i>Content</i>	<i>Digit</i>	<i>Example</i>
	Module serial number	1 - 5	71549
	Module material number	6 - 11	142846
	Production order number	12 - 19	55054991
	Date code (production year)	20 - 21	15
	Date code (production week)	22 - 23	30
Example	 		
	71549142846550549911530		71549142846550549911530

Figure 3

Revision history

Document revision	Date of release	Description of changes
0.10	2023-10-04	Initial version
1.00	2024-04-09	Final datasheet

Trademarks

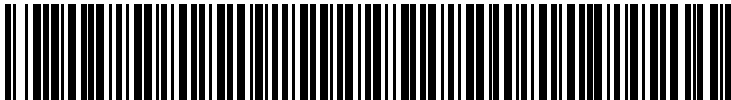
All referenced product or service names and trademarks are the property of their respective owners.

Edition 2024-04-09

Published by

Infineon Technologies AG

81726 Munich, Germany

© 2024 Infineon Technologies AG

All Rights Reserved.

Do you have a question about any aspect of this document?

Email: erratum@infineon.com

Document reference

IFX-ABH459-002

Important notice

The information given in this document shall in no event be regarded as a guarantee of conditions or characteristics ("Beschaffheitsgarantie").

With respect to any examples, hints or any typical values stated herein and/or any information regarding the application of the product, Infineon Technologies hereby disclaims any and all warranties and liabilities of any kind, including without limitation warranties of non-infringement of intellectual property rights of any third party.

In addition, any information given in this document is subject to customer's compliance with its obligations stated in this document and any applicable legal requirements, norms and standards concerning customer's products and any use of the product of Infineon Technologies in customer's applications.

The data contained in this document is exclusively intended for technically trained staff. It is the responsibility of customer's technical departments to evaluate the suitability of the product for the intended application and the completeness of the product information given in this document with respect to such application.

Warnings

Due to technical requirements products may contain dangerous substances. For information on the types in question please contact your nearest Infineon Technologies office.

Except as otherwise explicitly approved by Infineon Technologies in a written document signed by authorized representatives of Infineon Technologies, Infineon Technologies' products may not be used in any applications where a failure of the product or any consequences of the use thereof can reasonably be expected to result in personal injury.