

# XC9145B36CER-G Evaluation Board User Manual

**400nA Ultra-Low Quiescent, 0.8A, PWM/PFM Step-up DC/DC Converters**

## **CAUTION**

### **ENGINEERING EVALUATION PURPOSES ONLY**

This evaluation board is made for the purpose of the product evaluation. It is strictly prohibited to use this evaluation board for any other purpose.

Torex Semiconductor does not guarantee that all samples will perform in exactly the same way and we recommend that you always consult our product data sheets for the minimum and maximum specifications.

It is also important that you evaluate all our products carefully before mass

## **XC9145B36CE-G Evaluation Board**

*400nA Ultra-Low Quiescent, 0.8A, PWM/PFM Step-up DC/DC Converters*

### **Evaluation Board Picture**

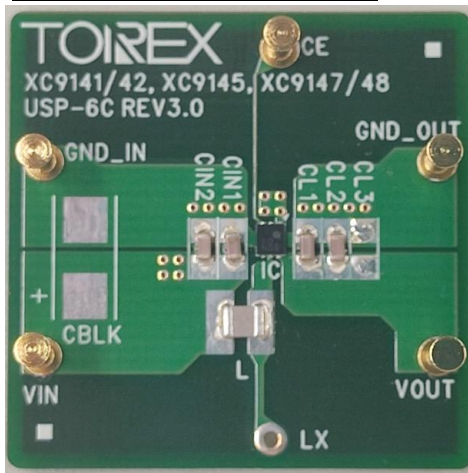

### **Evaluation Board SPEC**

Ta=25°C

		CONDITON.	MIN.	TYP.	MAX.	UNIT
Vin	Input Voltage Range	-	0.65	-	5.5	V
	Operation Start Voltage	-	-	-	1.6	V
Vout	Setting Output Voltage	-	-	3.6	-	V
Iout	Output Current	-	Refer to Graph 7			mA
fosc	Switching frequency	-	-	1.2	-	MHz

### **XC9145 Series Features**

- Input Voltage Range ..... 0.65V ~ 5.5V
- Operation Start Voltage ..... 1.6V
- Output Voltage Range ..... 3.0V ~ 5.5V (step 0.1V)
- Switching frequency ..... 1.2MHz
- Ultra Low Power Solution

# XC9145B36CER-G Evaluation Board

400nA Ultra-Low Quiescent, 0.8A, PWM/PFM Step-up DC/DC Converters

## Quick Start Procedure

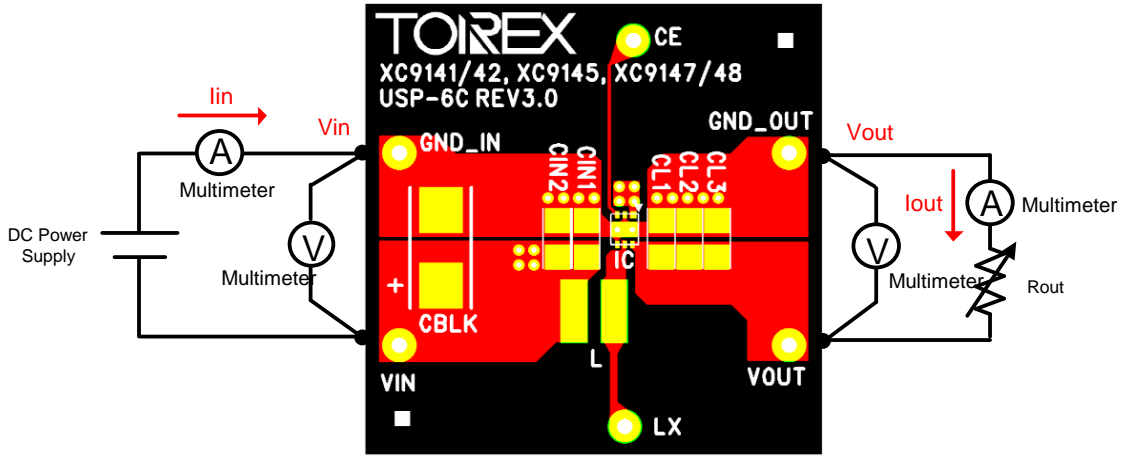

## **XC9145B36CER-G Evaluation Board**

400nA Ultra-Low Quiescent, 0.8A, PWM/PFM Step-up DC/DC Converters

### **Schematic**

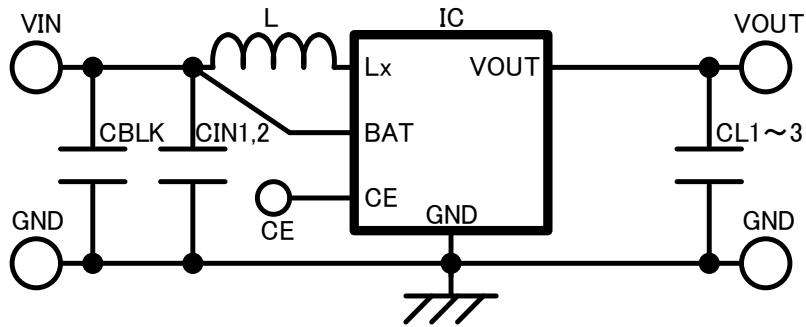

### **BOM**

#### **Required Circuit Component**

Item	Value	Description	Size [mm]	Part Number	Manufacture
IC	-	Step-up DC/DC converter	USP-6C	XC9145B36CER-G	TOREX
L	4.7uF	Inductor, Isat=2.1A	2520	DFE252012F-4R7M	Murata
CIN1	10uF	Ceramic cap., 16V/10uF	1608	GRM188R61C106MA73	Murata
CIN2	10uF	Ceramic cap., 16V/10uF	1608	GRM188R61C106MA73	Murata
CL1	10uF	Ceramic cap., 16V/10uF	1608	GRM188R61C106MA73	Murata
CL2	10uF	Ceramic cap., 16V/10uF	1608	GRM188R61C106MA73	Murata
CL3	-	-	-	-	-

#### **Additional Demo Board Circuit Components**

Item	Value	Description	Size [mm]	Part Number	Manufacture
CBLK	-	-	-	-	-

## **XC9145B36CER-G Evaluation Board**

*400nA Ultra-Low Quiescent, 0.8A, PWM/PFM Step-up DC/DC Converters*

### **PCB Layout**

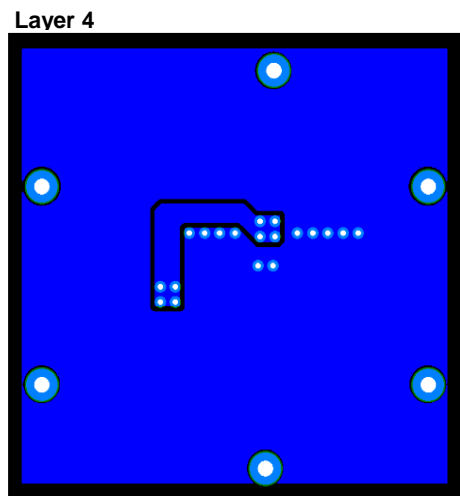
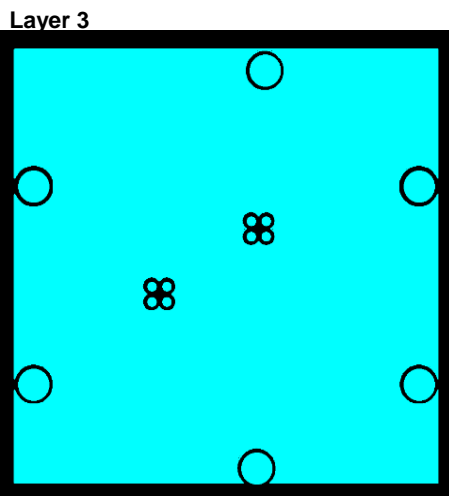
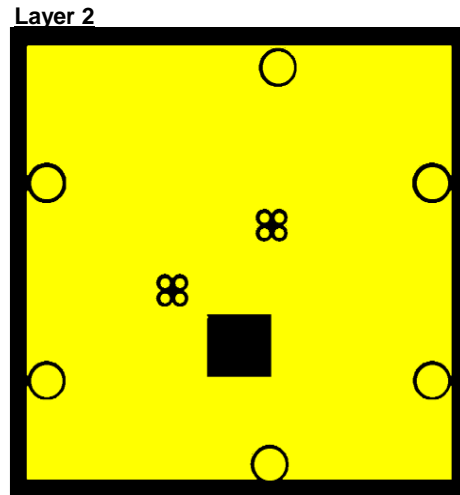
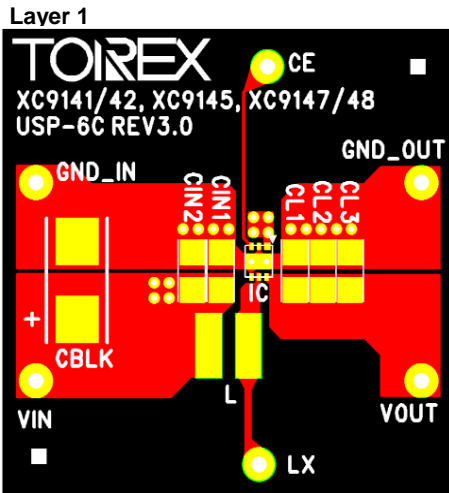

## **XC9145B36CER-G Evaluation Board**

400nA Ultra-Low Quiescent, 0.8A, PWM/PFM Step-up DC/DC Converters

### **Test Result**

**(1) Output Voltage vs Output Current @Ta=25°C**

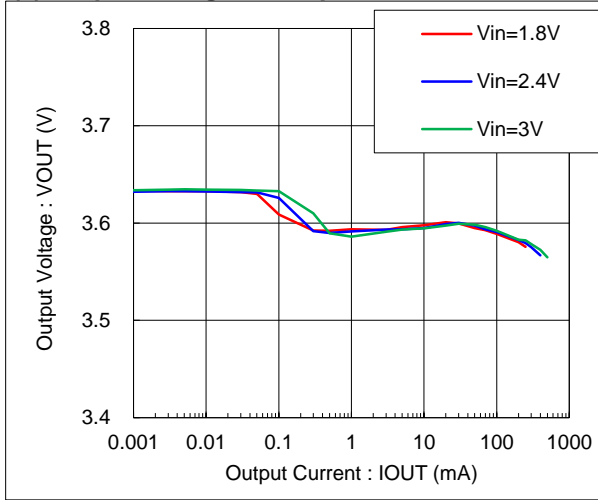

**(2) Efficiency vs Output Current Ta=25°C**

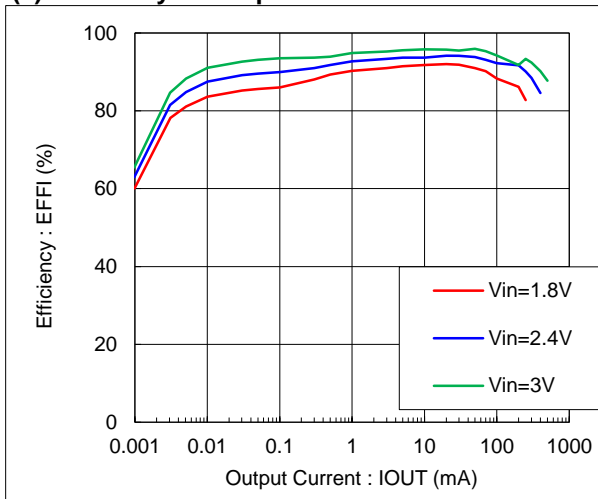

**(3) Ripple Voltage vs Output Current Ta=25°C**

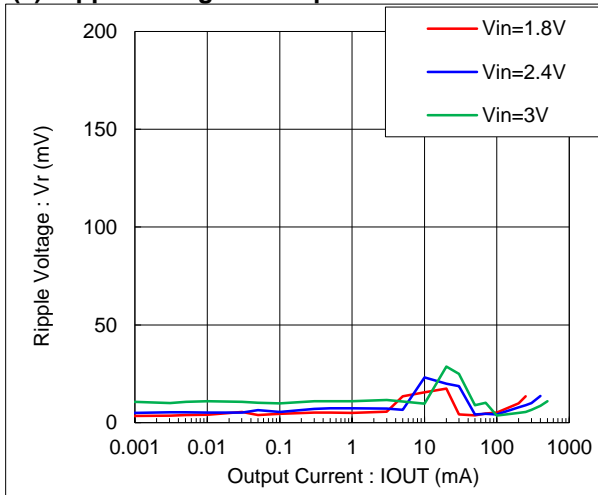

## **XC9145B36CER-G Evaluation Board**

*400nA Ultra-Low Quiescent, 0.8A, PWM/PFM Step-up DC/DC Converters*

**(7) Max Output Current vs BAT Voltage(Input Voltage) @ Ta=25°C**

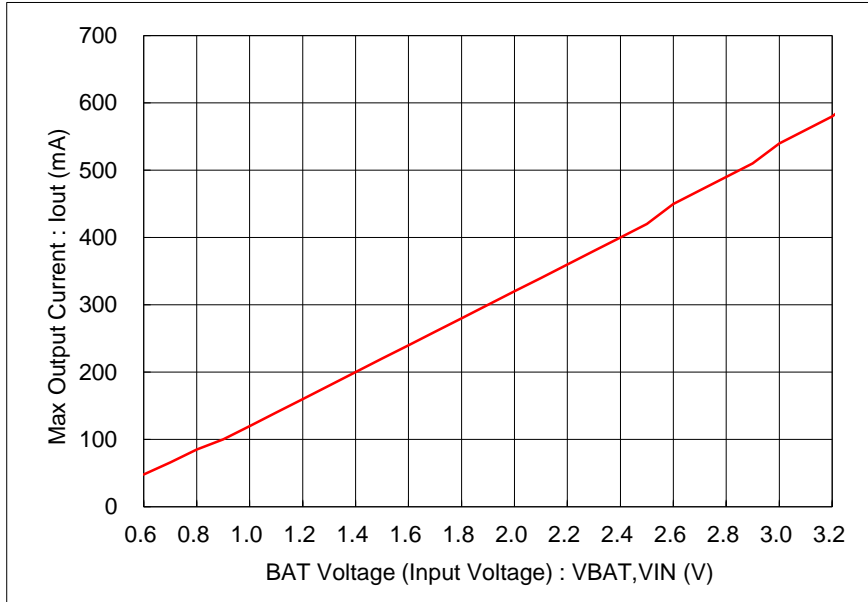

# XC9145B36CER-G Evaluation Board

400nA Ultra-Low Quiescent, 0.8A, PWM/PFM Step-up DC/DC Converters

## 【Appendix】 How to calculate DC/DC Converter or DC/DC Controller.

It can be calculated by the following "WEB DC/DC Simulation".

Product	XC9145 Product Info
Switching frequency	1200 [kHz]
Control Method	PWM/PFM
Sim Condition	
Vin	3.3 [V] Range: 0.65V~5.5V
Vout	5 [V] Range: 3V~5.5V
Iout	30 [mA] Range: 0mA~
Rvin (Battery Impedance etc)	0 [Ω]
Ta	25 [°C] Range: -40~105°C
Thermal resistance: θja	83.33 [°C/W] Range: 0~1000°C/W
External Components	
L	4.7 [μH]
DCR	28.5 [mΩ]
CL (Effective Value)	10 [μF]
ESR	2.5 [mΩ]

Schematic Summary	Waveform	Efficiency Tj, Duty	Ripple Voltage Vin Voltage	Coil Current Input Current	Switching frequency
-------------------	----------	---------------------	----------------------------	----------------------------	---------------------

This result consists of TYP data which does not account for variations in ICs. Inconsistencies in IC production may cause the maximum output current to decrease to a value below this result.

### Schematic

### Summary

Iout max: 660 [mA]

Summary@Iout=30mA

Efficiency:	94.27 [%]	Input Power:	0.1591 [W]
IC Loss:	7.821 [mW]	Output Power:	0.15 [W]
Inductor Loss:	1.283 [mW]	Vin Pin:	3.3 [V]
Tj:	25.65 [°C]	Bottom Coil Current:	0 [mA]
Input Current:	48.21 [mA]	MODE:	PWM/PFM_DCM
Peak Coil Current:	200 [mA]	Switching frequency:	582 [kHz]
On time:	0.2871 [us]	Duty:	16.71 [%]
Off time:	0.5414 [us]	Ripple Voltage:	4.215 [mV]

- 日本語 : <https://www.torex.co.jp/technical-support/dcdc-simulation/>
- English : <https://www.torexsemi.com/technical-support/dcdc-simulation/>
- 简体中文 : <https://www.torex.com.cn/technical-support/dcdc-simulation/>



# XC9145B36CER-G Evaluation Board

400nA Ultra-Low Quiescent, 0.8A, PWM/PFM Step-up DC/DC Converters

**[Appendix]** How to reduce the spike noise caused by measurement (Probing method with oscilloscope)

**Probing method : Before improvement**

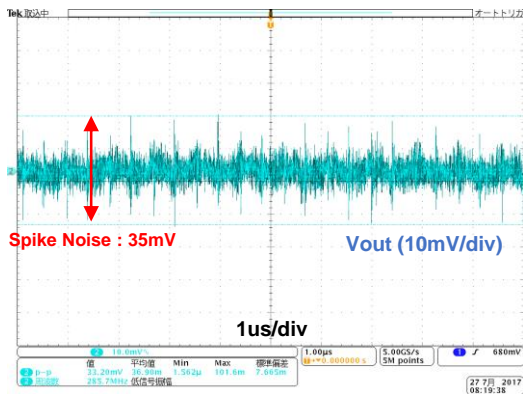
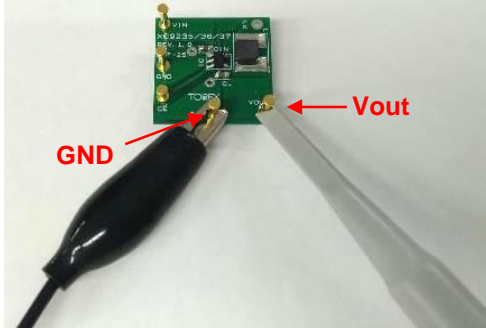

**Probing method : After**

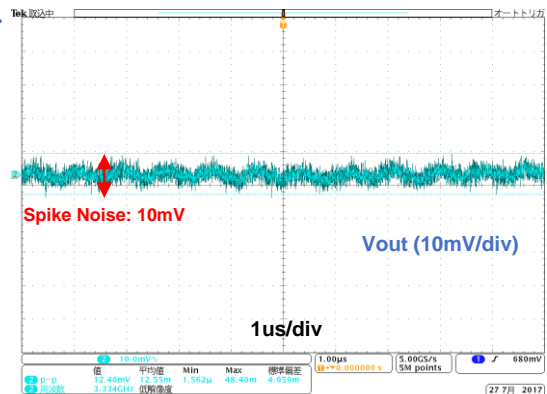
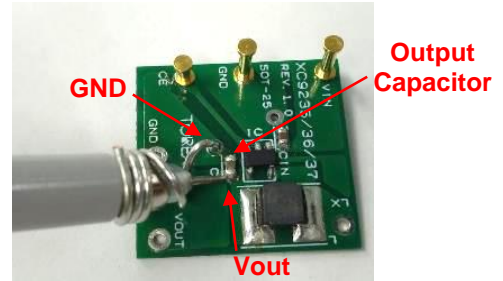

\* Condition : XC9236, Vin=3.6V/Vout=1.8V/100mA

English : <https://www.torexsemi.com/technical-support/tips/reduction-spike-noise/>

日本語 : <https://www.torex.co.jp/technical-support/tips/reduction-spike-noise/>