

XC9290/XC9291 Series

ETR05089-001d

HiSAT-COT[®] Control Extremely Small 600mA Step-Down DC/DC Converters

☆Green Operation Compatible

■ GENERAL DESCRIPTION

The XC9290/XC9291 series are 600mA synchronous rectification DC/DC converters adopting HiSAT-COT^(*) control. Due to increasing the oscillation frequency to high frequency, coil with a size of 0.8 x 0.45 mm can be used. A 0.6 x 0.3 mm ceramic capacitor can be used for the input capacitance (C_{IN}) and the output capacitance (C_L), realizing that the mounting area including peripheral components can be reduced to 3.15 mm².

Due to increasing the oscillation frequency to a high frequency, the mounting area is reduced. Additionally, an efficiency equal to or higher than that of conventional products can realize by improving on-resistance and current consumption. Because of these features, XC9290/XC9291 series are ideal for equipment requiring miniaturization and low-profile mounting area, and battery-powered equipment such as mobile equipment.

Moreover, the high-speed transient response technology of the HiSAT-COT control makes it possible to minimize the fluctuation of the output voltage for a load transient condition. This feature is optimal for applications requiring a fast response and output voltage stability for an instantaneous load fluctuation like FPGA.

(*) HiSAT-COT is a proprietary high-speed transient response technology for DC/DC converter which was developed by Torex. It is ideal for the LSI's that require high precision and high stability power supply voltage.

■ APPLICATIONS

- Smart phones / Mobile phones
- Wireless earphone / Headset
- Wearable devices
- DSC / Camcorder
- Portable game consoles
- Smartcard
- Power supply for module
- Various small power sources

■ FEATURES

Input Voltage Range	: 2.5V ~ 6.0V
Output Voltage Range	: 0.7V ~ 3.6V ($\pm 2.0\%$)
Output Current	: 600mA
Quiescent Current	: 11 μ A
Oscillation Frequency	: 4MHz, 6MHz
Efficiency ($f_{osc}=4MHz$)	: 90.0% ($V_{IN}=3.7V, V_{OUT}=1.8V, I_{OUT}=200mA$)
Control Methods	: HiSAT-COT Control PWM Control (XC9290) PWM/PFM Auto (XC9291)
Protection Functions	: Current Limit
Functions	: Soft-Start, UVLO C_L Discharge (Type B)
Input / Output Capacitor	: Ceramic Capacitor
Operating Ambient Temperature	: -40°C ~ 105°C
Package	: LGA-6B01 (1.2 x 1.2 x 0.3mm) WLP-5-08 (0.88 x 0.96 x 0.33mm)
Environmentally	: EU RoHS Compliant, Pb Free

■ PCB IMAGE



■ TYPICAL APPLICATION CIRCUIT

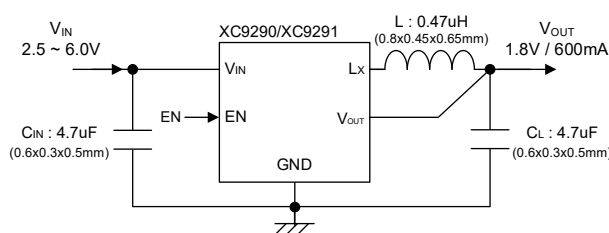

■ TYPICAL PERFORMANCE CHARACTERISTICS

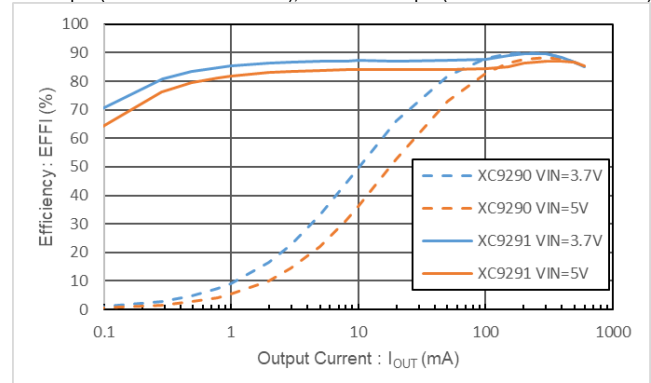
XC9290B18D / XC9291B18D ($V_{OUT}=1.8V, f_{osc}=4MHz$)L = 1.0 μ H (DFE18SAN1R0MG0L), $C_{IN} = C_L = 4.7\mu$ F (GRM035R60J475ME15)

■ BLOCK DIAGRAM

1) Type A

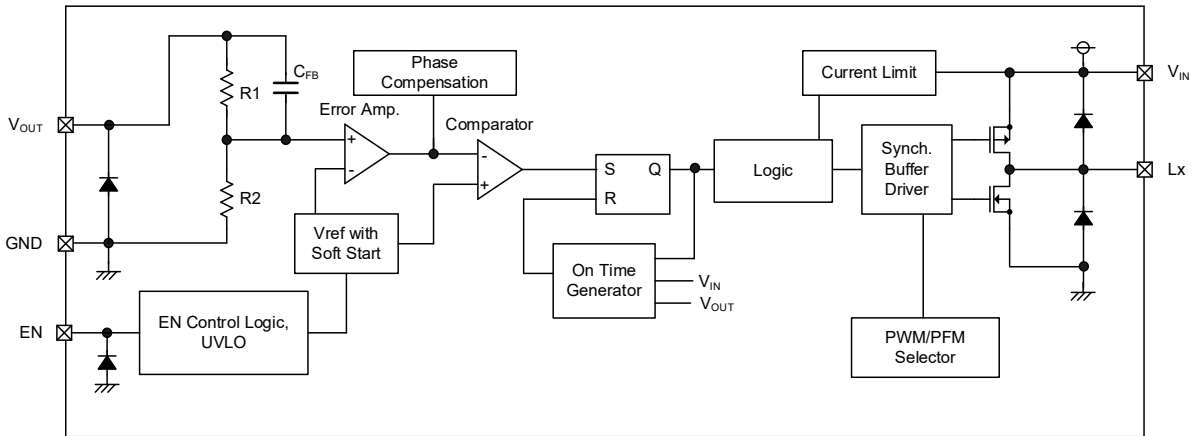

(*) "PWM/PFM Selector" in the XC9290 series is fixed to PWM control.

"PWM/PFM Selector" In the XC9291 series is fixed to PWM/PFM automatic switching control.

Diodes inside the circuit are an ESD protection diode and a parasitic diode.

2) Type B

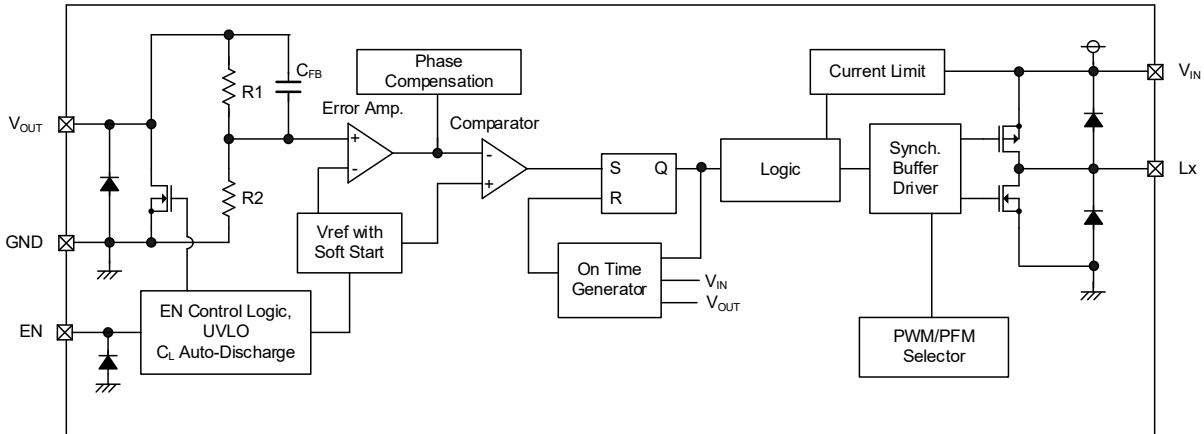

(*) "PWM/PFM Selector" in the XC9290 series is fixed to PWM control.

"PWM/PFM Selector" In the XC9291 series is fixed to PWM/PFM automatic switching control.

Diodes inside the circuit are an ESD protection diode and a parasitic diode.

■ PRODUCT CLASSIFICATION

● Ordering Information

XC9290①②③④⑤⑥-⑦ : PWM Control

XC9291①②③④⑤⑥-⑦ : PWM/PFM Automatic switching control

DESIGNATOR	ITEM	SYMBOL	DESCRIPTION
①	Type	A	Refer to Selection Guide
		B	
②③	Output Voltage	07 ~ 36	Output voltage e.g. 1.2V → ②=1, ③=2 1.25V → ②=1, ③=C 0.05V increments : 0.05=A, 0.15=B, 0.25=C, 0.35=D, 0.45=E, 0.55=F, 0.65=H, 0.75=K, 0.85=L, 0.95=M
④	Oscillation Frequency	D	4.0MHz
		E	6.0MHz
⑤⑥-⑦ ^(*)	Packages (Order Unit)	1R-G	LGA-6B01 (5,000pcs/Reel)
		0R-G	WLP-5-08 (5,000pcs/Reel)

^(*) The "-G" suffix denotes Halogen and Antimony free as well as being fully EU RoHS compliant.

● Selection Guide

FUNCTION	A TYPE	B TYPE
Enable	Yes	
UVLO	Yes	
Soft-Start Time	Fixed	
C _L Discharge	No	Yes
Current Limit (Automatic Recovery)	Yes	

PIN CONFIGURATION

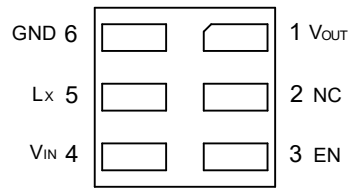

LGA-6B01
(BOTTOM VIEW)

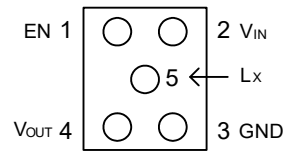

WLP-5-08
(BOTTOM VIEW)

PIN ASSIGNMENT

PIN NUMBER		PIN NAME	FUNCTIONS
LGA-6B01	WLP-5-08		
1	4	V _{OUT}	Output Voltage Monitor
2	-	NC	No Connection
3	1	EN	Enable
4	2	V _{IN}	Power Input
5	5	Lx	Switching
6	3	GND	Ground

FUNCTION

PIN NAME	SIGNAL	STATUS
EN	L	Stand-by
	H	Active
	OPEN	Undefined State ^(*)

^(*) Please do not leave the EN pin open.

■ ABSOLUTE MAXIMUM RATINGS

PARAMETER		SYMBOL	RATINGS	UNITS
V _{IN} Pin Voltage		V _{IN}	-0.3 ~ 7.0	V
Lx Pin Voltage		V _{Lx}	-0.3 ~ V _{IN} + 0.3 or 7.0 ^{(*)1}	V
V _{OUT} Pin Voltage		V _{OUT}	-0.3 ~ V _{IN} + 0.3 or 4.0 ^{(*)2}	V
EN Pin Voltage		V _{EN}	-0.3 ~ 7.0	V
Power Dissipation (T _a =25°C)	LGA-6B01	P _d	760 (JESD51-7 board) ^{(*)3}	mW
	WLP-5-08		500 (JESD51-7 board) ^{(*)3}	
Operating Ambient Temperature		Topr	-40 ~ 105	°C
Storage Temperature		Tstg	-55 ~ 125	°C

* All voltages are described based on the GND pin.

^{(*)1} The maximum value should be either V_{IN}+0.3V or 7.0V in the lowest.

^{(*)2} The maximum value should be either V_{IN}+0.3V or 4.0V in the lowest.

^{(*)3} The power dissipation figure shown is PCB mounted and is for reference only.
Please refer to PACKAGING INFORMATION for the mounting condition.

■ RECOMMENDED OPERATING CONDITIONS

PARAMETER		SYMBOL	MIN.	TYP.	MAX.	UNITS	
Input Voltage		V _{IN}	2.5	-	6.0	V	
EN Pin Voltage		V _{EN}	0.0	-	6.0	V	
Operating Ambient Temperature		Topr	-40	-	105	°C	
Input Capacitor (Effective Value)		C _{IN}	0.63	-	1000 ^{(*)2}	μF	
Output Capacitor (Effective Value)	V _{OUT(T)} <1.0V	C _L	4.13	-	100 ^{(*)3}	μF	
	1.0V ≤ V _{OUT(T)} <1.2V		3.76				
	1.2V ≤ V _{OUT(T)} <1.5V		3.29				
	1.5V ≤ V _{OUT(T)} <1.9V		2.82				
	1.9V ≤ V _{OUT(T)} <2.4V		2.35				
	2.4V ≤ V _{OUT(T)} <3.2V		1.88				
	3.2V ≤ V _{OUT(T)}		1.41				
Inductor	f _{OSC} = 4.0MHz	L	V _{OUT(T)} ≤ 1.8V	0.47 x 0.7	1.0	2.2 x 1.3	μH
			1.8V < V _{OUT(T)}	1.0 x 0.7	1.0	2.2 x 1.3	
	f _{OSC} = 6.0MHz		0.47 x 0.7	0.47	1.0 x 1.3		

* All voltages are described based on the GND pin.

^{(*)1} Some ceramic capacitors have an effective capacitance that is significantly lower than the nominal value due to the applied DC bias and ambient temperature. For the input / output capacitance of this IC, use an appropriate ceramic capacitor according to the DC bias usage conditions (ambient temperature, input / output voltage) so that the effective capacitance value is equal to or higher than the recommended component.

^{(*)2} If using a large-capacity capacitor such as an electrolytic capacitor or tantalum capacitor as the input capacitance, place a low ESR ceramic capacitor in parallel. If a ceramic capacitor is not placed, high-frequency voltage fluctuations will increase and the IC may malfunction.

^{(*)3} If using a large-capacity capacitor as the output capacitance, output stability may decrease and ripple voltage may increase. Even within the recommended capacitance range, output stability may be reduced depending on the type of capacitor such as ESR etc. used, so please verify this fully on the actual equipment before using.

ELECTRICAL CHARACTERISTICS

Ta=25°C

PARAMETER	SYMBOL	CONDITIONS	MIN.	TYP.	MAX.	UNITS	CIRCUIT
Output Voltage ^(*)	V _{OUT}	V _{IN} =V _{OUT(T)} +2.0V V _{OUT} =V _{OUT(T)} ×1.2→V _{OUT(T)} ×0.8 V _{OUT} Voltage when Lx pin voltage changes from "L" level to "H" level	<E-1>	<E-2>	<E-3>	V	①
Operating Voltage Range	V _{IN}		2.5	-	6.0	V	②
Maximum Output Current	I _{OUTMAX}	When connected to external components, V _{IN} =V _{OUT(T)} +2.0V	600	-	-	mA	②
UVLO Detect Voltage	V _{UVLOD}	V _{IN} =2.5V to 1.6V, V _{OUT} =0V, V _{EN} =V _{IN} V _{IN} voltage when Lx pin changes from "H" to "L" level	1.7	2.0	-	V	①
UVLO Release Voltage	V _{UVLOR}	V _{IN} =1.6V to 2.5V, V _{OUT} =0V, V _{EN} =V _{IN} V _{IN} voltage when Lx pin changes from "L" to "H" level	-	2.14	2.3	V	①
Quiescent Current (XC9290)	I _q	V _{OUT} =4.0V	-	700	1560	μA	③
Quiescent Current (XC9291)	I _q	V _{OUT} =4.0V	-	11.0	24.0	μA	③
Stand-by Current	I _{STB}	V _{IN} =6.0V, V _{EN} =0V, V _{OUT} =0V, V _{LX} =0V	-	0.0	0.6	μA	④
ON time	t _{ON}	When connected to external components, V _{IN} =V _{OUT(T)} +2.0V, I _{OUT} =1mA	-	<E-5>	-	ns	②
Lx SW "H" ON Resistance	R _{LXH}	V _{IN} =3.6V, V _{OUT} =0V, I _{LX} =100mA	-	0.32	- 0.50	Ω	⑥
Lx SW "L" ON Resistance	R _{LXL}	V _{IN} =3.6V, V _{OUT} =3.9V, I _{LX} =100mA	-	0.26	- 0.35	Ω	⑤
Lx SW "H" Leakage Current	I _{LeakH}	V _{IN} =6.0V, V _{EN} =0V, V _{OUT} =0V, V _{LX} =6.0V	-	0.0	1.0	μA	④
Lx SW "L" Leakage Current	I _{LeakL}	V _{IN} =6.0V, V _{EN} =0V, V _{OUT} =0V, V _{LX} =0V	-	0.0	0.3	μA	④
Current Limit	I _{LIMH}	V _{IN} =3.6V, V _{OUT} =0V, I _{LX} until Lx pin oscillates	770 (*)	1000	1500 (*)	mA	⑥
Output Voltage Temperature Characteristics	ΔV _{OUT} / (V _{OUT} * ΔT _{opr})	V _{IN} =V _{OUT(T)} +2.0V V _{OUT} =V _{OUT(T)} ×1.2→V _{OUT(T)} ×0.8 V _{OUT} Voltage when Lx pin voltage changes from "L" level to "H" level, -40°C ≤ T _{opr} ≤ 105°C	-	±100	-	ppm/ °C	①
EN "H" Voltage	V _{ENH}	V _{IN} =6.0V, V _{OUT} =0V, V _{EN} Voltage which Lx pin holding "H" level	1.2	-	6.0	V	①
EN "L" Voltage	V _{ENL}	V _{IN} =6.0V, V _{OUT} =0V, V _{EN} Voltage which Lx pin holding "L" level	GND	-	0.3	V	①
EN "H" Current	I _{ENH}	V _{EN} =6.0V, V _{OUT} =4.0V	-0.1	0.0	0.1	μA	③
EN "L" Current	I _{ENL}	V _{IN} =6.0V, V _{EN} =0V, V _{OUT} =0V	-0.1	0.0	0.1	μA	④
Soft-Start Time	t _{SS}	V _{IN} =3.6V, V _{EN} =0V→3.6V, V _{OUT} =V _{OUT(T)} ×0.9 After "H" is fed to EN, the time by when clocks are generated at Lx pin.	54	130	240	μs	①
C _L Discharge Resistance (B Type)	R _{DCHG}	V _{EN} =0V, V _{OUT} =1.0V	150	180	210	Ω	⑦

Unless otherwise stated : V_{IN}=5V, V_{EN}=5V,

V_{OUT(T)}=Nominal Value,

"H" level = V_{IN} - 1.2V ~ V_{IN}, "L" level = -0.1V ~ 0.1V

NOTE:

(*) For PWM control.

(*) Design value for WLP-5-08

(*) Design value

ELECTRICAL CHARACTERISTICS (Continued)

SPEC Table

NOMINAL OUTPUT VOLTAGE	V _{OUT}			t _{ON}	
				f _{osc} =4.0MHz	f _{osc} =6.0MHz
	<E-1>	<E-2>	<E-3>	<E-5>	<E-5>
UNITS	V	V	V	ns	ns
V _{OUT(T)}	MIN.	TYP.	MAX.	TYP.	TYP.
0.70	0.686	0.700	0.714	65	43
0.75	0.735	0.750	0.765	68	45
0.80	0.784	0.800	0.816	71	48
0.85	0.833	0.850	0.867	75	50
0.90	0.882	0.900	0.918	78	52
0.95	0.931	0.950	0.969	81	54
1.00	0.980	1.000	1.020	83	56
1.05	1.029	1.050	1.071	86	57
1.10	1.078	1.100	1.122	89	59
1.15	1.127	1.150	1.173	91	61
1.20	1.176	1.200	1.224	94	63
1.25	1.225	1.250	1.275	96	64
1.30	1.274	1.300	1.326	98	66
1.35	1.323	1.350	1.377	101	67
1.40	1.372	1.400	1.428	103	69
1.45	1.421	1.450	1.479	105	70
1.50	1.470	1.500	1.530	107	71
1.55	1.519	1.550	1.581	109	73
1.60	1.568	1.600	1.632	111	74
1.65	1.617	1.650	1.683	113	75
1.70	1.666	1.700	1.734	115	77
1.75	1.715	1.750	1.785	117	78
1.80	1.764	1.800	1.836	118	79
1.85	1.813	1.850	1.887	120	80
1.90	1.862	1.900	1.938	122	81
1.95	1.911	1.950	1.989	123	82
2.00	1.960	2.000	2.040	125	83
2.05	2.009	2.050	2.091	127	84
2.10	2.058	2.100	2.142	128	85
2.15	2.107	2.150	2.193	130	86
2.20	2.156	2.200	2.244	131	87
2.25	2.205	2.250	2.295	132	88
2.30	2.254	2.300	2.346	134	89
2.35	2.303	2.350	2.397	135	90
2.40	2.352	2.400	2.448	136	91
2.45	2.401	2.450	2.499	138	92
2.50	2.450	2.500	2.550	139	93
2.55	2.499	2.550	2.601	140	93
2.60	2.548	2.600	2.652	141	94

ELECTRICAL CHARACTERISTICS (Continued)

SPEC Table

NOMINAL OUTPUT VOLTAGE	V _{OUT}			t _{ON}	
				f _{osc} =4.0MHz	f _{osc} =6.0MHz
	<E-1>	<E-2>	<E-3>	<E-5>	<E-5>
UNITS	V	V	V	ns	ns
V _{OUT(T)}	MIN.	TYP.	MAX.	TYP.	TYP.
2.65	2.597	2.650	2.703	142	95
2.70	2.646	2.700	2.754	144	96
2.75	2.695	2.750	2.805	145	96
2.80	2.744	2.800	2.856	146	97
2.85	2.793	2.850	2.907	147	98
2.90	2.842	2.900	2.958	148	99
2.95	2.891	2.950	3.009	149	99
3.00	2.940	3.000	3.060	150	100
3.05	2.989	3.050	3.111	151	101
3.10	3.038	3.100	3.162	152	101
3.15	3.087	3.150	3.213	153	102
3.20	3.136	3.200	3.264	154	103
3.25	3.185	3.250	3.315	155	103
3.30	3.234	3.300	3.366	156	104
3.35	3.283	3.350	3.417	157	104
3.40	3.332	3.400	3.468	157	105
3.45	3.381	3.450	3.519	158	106
3.50	3.430	3.500	3.570	159	106
3.55	3.479	3.550	3.621	160	107
3.60	3.528	3.600	3.672	161	107

TEST CIRCUITS

< Circuit No.① >

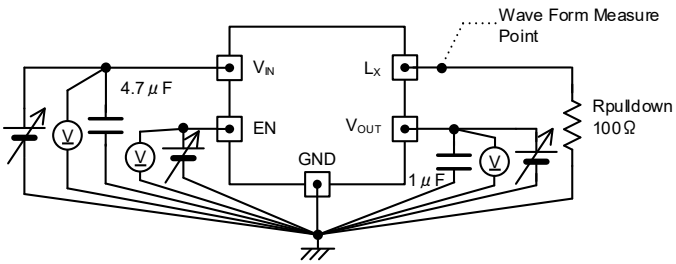

< Circuit No.② >

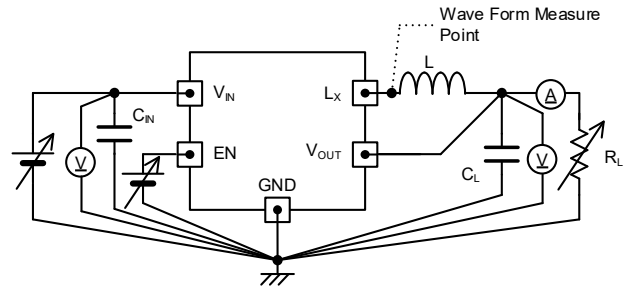

fosc=4MHz
L : 1.0 μH
C_{IN} : 4.7 μF(ceramic)
C_L : 4.7 μF(ceramic)

fosc=6MHz
L : 0.47 μH
C_{IN} : 4.7 μF(ceramic)
C_L : 4.7 μF(ceramic)

< Circuit No.③ >

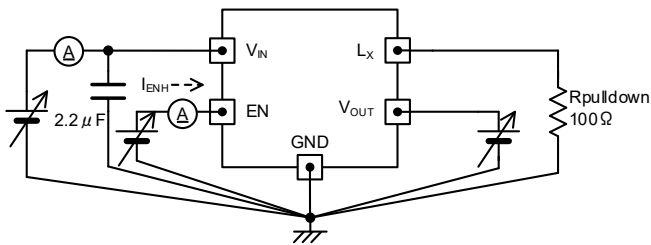

< Circuit No.④ >

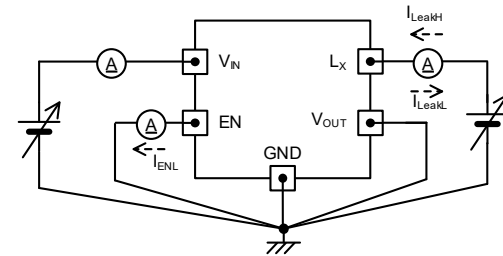

< Circuit No.⑤ >

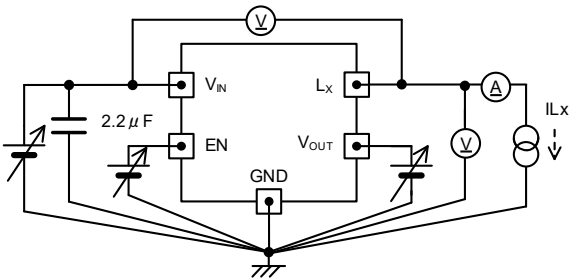

< Circuit No.⑥ >

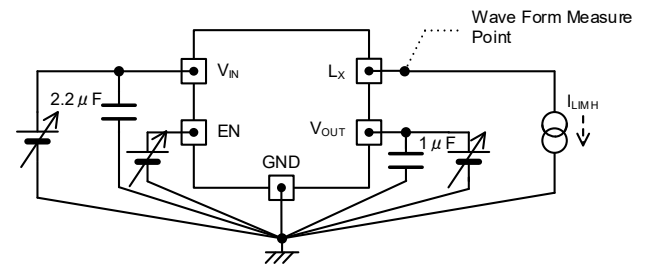

< Circuit No.⑦ >
B TYPE

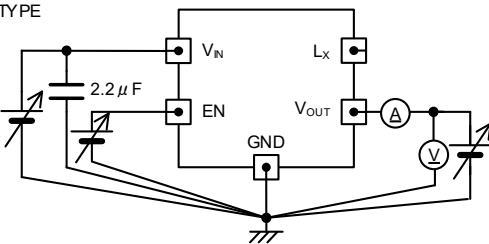

TYPICAL APPLICATION CIRCUIT

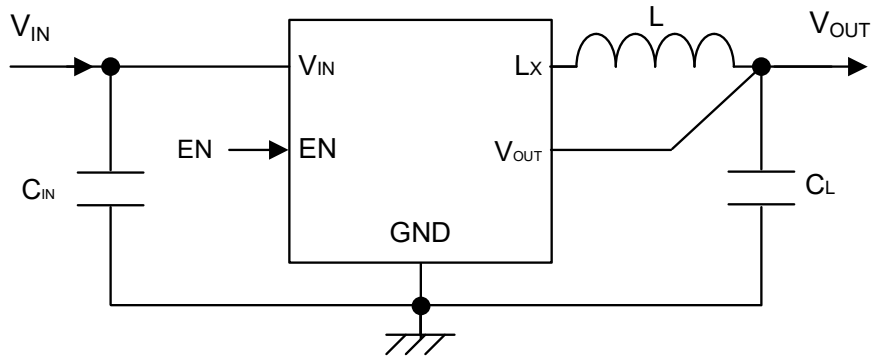

【Typical Examples】 $f_{osc}=4.0\text{MHz}$

Condition : $V_{OUT(T)} \leq 1.8\text{V}$

	MANUFACTURER	PRODUCT NUMBER	VALUE	SIZE(L×W×T)
L	TAIYO YUDEN	LSCNB1005EET1R0MB	1.0 μH	1.0×0.5×0.55(mm)
		LSCNB1005EETR47MB	0.47 μH	1.0×0.5×0.55(mm)
	TDK	TFM160808ALC-1R0MTAA	1.0 μH	1.6×0.8×0.8(mm)
	murata	DFE18SAN1R0MG0L	1.0 μH	1.6×0.8×1.0(mm)
		DFE18SANR47MG0L	0.47 μH	1.6×0.8×1.0(mm)
		DFE201210U-2R2M	2.2 μH	2.0×1.2×1.0(mm)

Condition : $1.8\text{V} < V_{OUT(T)}$

	MANUFACTURER	PRODUCT NUMBER	VALUE	SIZE(L×W×T)
L	TAIYO YUDEN	LSCNB1005EET1R0MB	1.0 μH	1.0×0.5×0.55(mm)
	TDK	TFM160808ALC-1R0MTAA	1.0 μH	1.6×0.8×0.8(mm)
	murata	DFE18SAN1R0MG0L	1.0 μH	1.6×0.8×1.0(mm)
		DFE201210U-2R2M	2.2 μH	2.0×1.2×1.0(mm)

【Typical Examples】 $f_{osc}=6.0\text{MHz}$

	MANUFACTURER	PRODUCT NUMBER	VALUE	SIZE(L×W×T)
L	TAIYO YUDEN	LSCNB1005EETR47MB	0.47 μH	1.0×0.5×0.55(mm)
		LSCNB1005EET1R0MB	1.0 μH	1.0×0.5×0.55(mm)
	murata	DFE18SANR47MG0L	0.47 μH	1.6×0.8×1.0(mm)
		DFE18SAN1R0MG0L	1.0 μH	1.6×0.8×1.0(mm)

■ TYPICAL APPLICATION CIRCUIT

【Typical Examples】^(*)

	MANUFACTURER	PRODUCT NUMBER	VALUE	SIZE(L×W×T)
C _{IN} ^(*)	murata	GRM035R60J475ME15	4.7μF/6.3V	0.6×0.3×0.5(mm)
	TDK	C1005X5R1A225K050BC	2.2μF/6.3V	1.0×0.5×0.5(mm)
	TAIYO YUDEN	MSASL105SB5225KFNA01	2.2μF/10V	1.0×0.5×0.5(mm)
C _L	murata	GRM035R60J475ME15	4.7μF/6.3V	0.6×0.3×0.5(mm)
	TDK	C1005X5R0J475K050BC	4.7μF/6.3V	1.0×0.5×0.5(mm)

^(*) Some ceramic capacitors have an effective capacitance that is significantly lower than the nominal value due to the applied DC bias and ambient temperature. For the input / output capacitance of this IC, use an appropriate ceramic capacitor according to the DC bias usage conditions (ambient temperature, input / output voltage) so that the effective capacitance value is equal to or higher than the recommended component.

⁽²⁾ If using a large-capacity capacitor such as an electrolytic capacitor or tantalum capacitor as the input capacitance, place a low ESR ceramic capacitor in parallel. If a ceramic capacitor is not placed, high-frequency voltage fluctuations will increase and the IC may malfunction.

⁽³⁾ If using a large-capacity capacitor as the output capacitance, output stability may decrease and ripple voltage may increase. Even within the recommended capacitance range, output stability may be reduced depending on the type of capacitor such as ESR etc. used, so please verify this fully on the actual equipment before using.

OPERATIONAL EXPLANATION

This IC consists of a reference voltage source, error amplifier, comparator, phase compensation, on time generation circuit, current limiter circuit, UVLO circuit and so on.

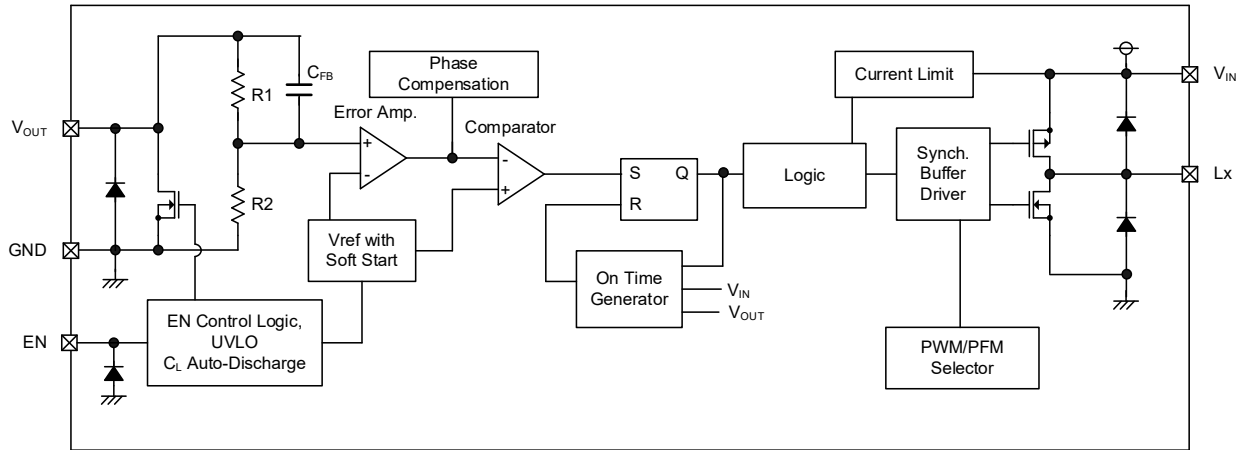

BLOCK DIAGRAM (Type B)

The control method is HiSAT-COT (High Speed circuit Architecture for Transient with Constant On Time), which features the On time control method and the fast transient response with low ripple voltage.

■ OPERATIONAL EXPLANATION (Continued)

<Normal operation>

In HiSAT-COT control, ON time (t_{ON}) dependent on input voltage and output voltage is generated and Pch driver FET. Is turned on.

The on-time is set as follows during light loads.

$$4\text{MHz} : t_{ON} = (V_{OUT} / V_{IN}) \times 250\text{ns}$$

$$6\text{MHz} : t_{ON} = (V_{OUT} / V_{IN}) \times 167\text{ns}$$

The on-time also depends on the output current. The above setting values may not be achieved under heavy loads.

The off time (t_{OFF}) is controlled by comparing the output voltage and the reference voltage with the error amplifier and the comparator. Specifically, the reference voltage and a voltage which is obtained by dividing the output voltage with R1 and R2 are compared with using the error amplifier, apply phase compensation to the output of the error amplifier, and send it to the comparator. In the comparator, the output of the error amplifier is compared with the reference voltage, and when it falls below the reference voltage, the SR latch is set and it becomes the ON period again.

XC9290 series

The XC9290 series (PWM control) operates in continuous conduction mode and operates at a stable oscillation frequency regardless of the load. The oscillation frequency can be obtained by the following equation.

$$f_{OSC} = (V_{OUT} / V_{IN}) \times (1 / t_{ON})$$

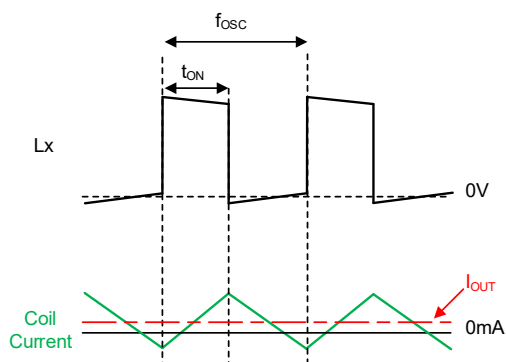

XC9290 series : Example of light load operation

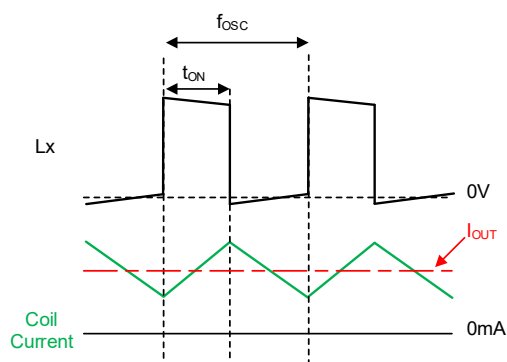

XC9290 series : Example of heavy load operation

XC9291 series

The XC9291 series (PWM/PFM automatic switching control) lowers the oscillation frequency at light load by operating in discontinuous conduction mode at light load.

As the output current increases, the switching frequency increases proportionally. By this operation, it is possible to reduce switching loss at light load and achieve high efficiency from light load to heavy load.

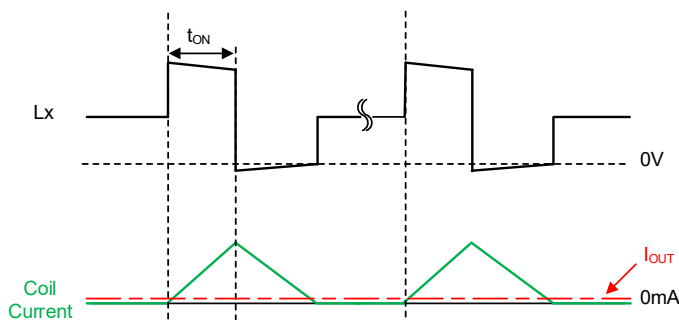

XC9291 series : Example of light load operation

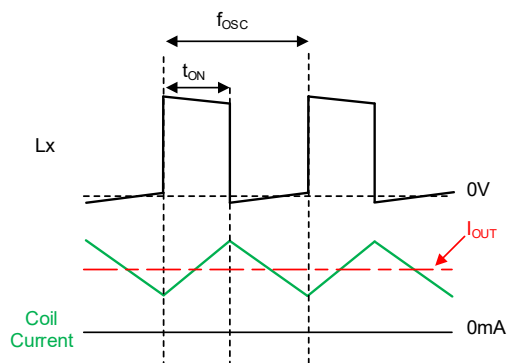

XC9291 series : Example of heavy load operation

OPERATIONAL EXPLANATION (Continued)

<100% Duty cycle mode>

In conditions where the input-output voltage difference is small or transient response, the Pch driver FET might keep on turning on and the 100% duty cycle mode might be set.

The 100% duty cycle mode achieves highspeed response and output voltage stability under the condition where input-output voltage difference is small.

<EN function>

When "H" voltage (V_{ENH}) is fed to the EN pin, normal operation starts after raising the output voltage with the soft-start function. When the "L" voltage (V_{ENL}) is fed to the EN pin, it enters the stand-by state and the current consumption is suppressed to I_{STB} (TYP. $0.0\mu A$).

Additionally, Pch driver FET and Nch driver FET are turned off.

<Start Mode / Soft-Start function>

It is a function to raise the output voltage gradually and suppress inrush current. After the "H" voltage (V_{ENH}) is fed to the EN pin, the reference voltage which is connected to the error amplifier increases linearly during the soft-start period. As a result, the output voltage increases in proportion to the increase of the reference voltage. This operation can prevent a large inrush current and smoothly raise the output voltage.

During the soft-start function, the operation is the same as normal operation except that the reference voltage increases linearly.

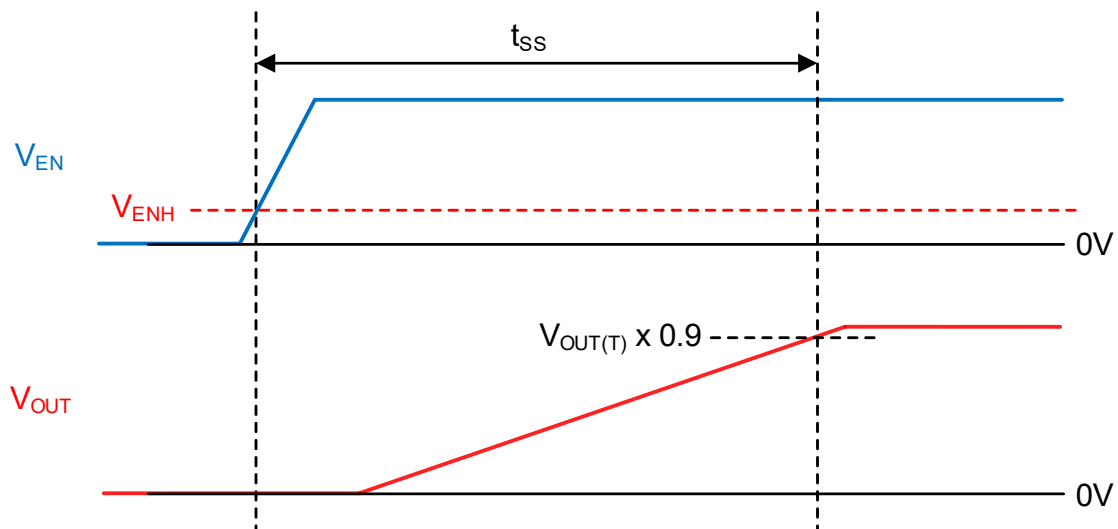

■ OPERATIONAL EXPLANATION (Continued)

<Current Limit>

The current limit function monitors a current flowing through Pch driver FET and Nch driver FET and limits the current. The operation at overcurrent is as follows.

- 1) When the current flowing through the Pch driver FET increases and reaches the current limit value $I_{LIMH}=1000\text{mA}$ (TYP.), the current limit state is set and the Pch driver FET is forcibly turned off.
- 2) The Nch driver FET turns on after turning off the Pch driver FET by the current limit function. The Pch driver FET is prohibited to turn on until the current value flowing through the Nch driver FET drops to $I_{LIML}=800\text{mA}$ (TYP.).
- 3) Repeat the operations 1) and 2) during the current limit state.
- 4) When the current limit state is canceled, it automatically returns to normal operation.

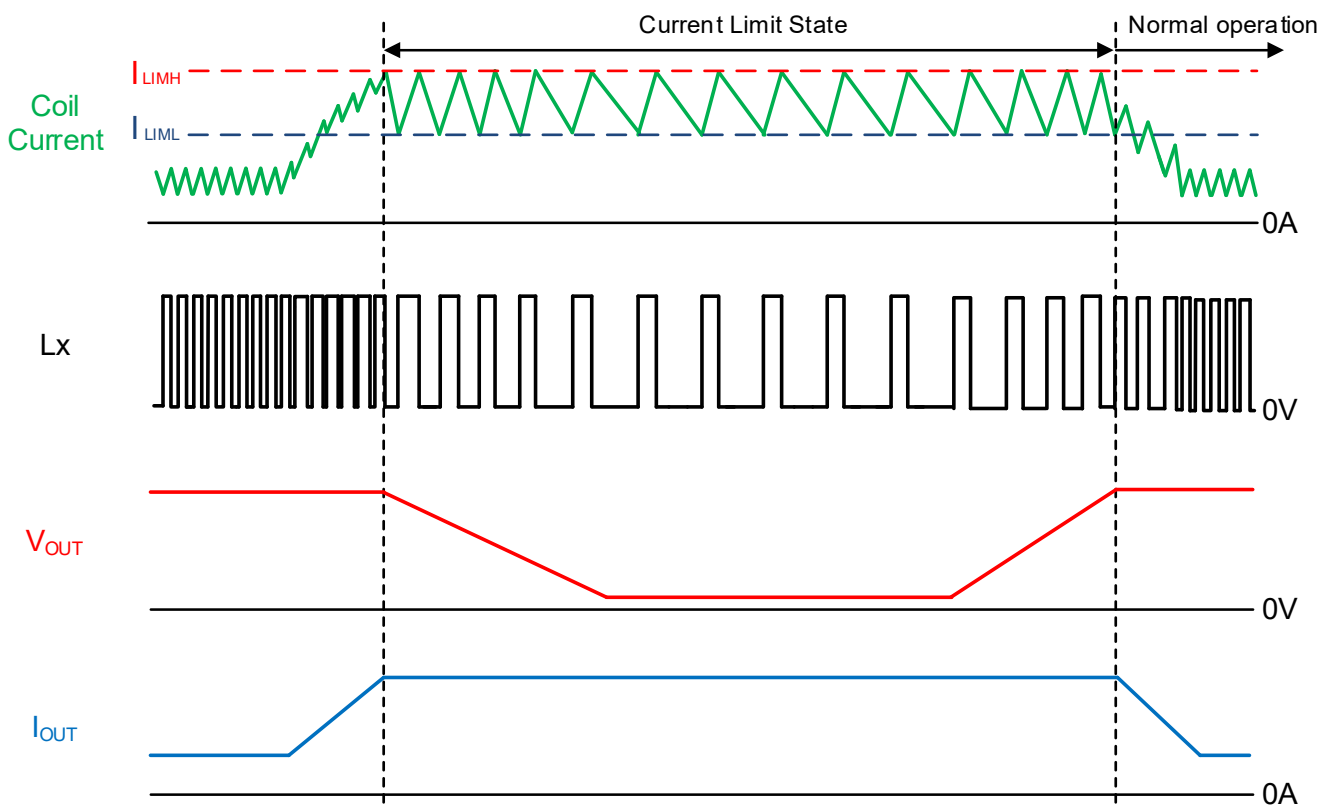

■ OPERATIONAL EXPLANATION (Continued)

<UVLO function>

When the V_{IN} voltage becomes V_{UVLOD} (TYP. 2.0V) or less, the UVLO function operates to forcibly turn off the Pch driver FET to prevent erroneous pulse output due to operation instability of the internal circuit.

When the V_{IN} voltage becomes V_{UVLOR} (TYP. 2.14V) or more, the UVLO function is canceled. After the UVLO function is canceled, the output voltage rises with the soft-start function, and then the normal operation is performed.

Moreover, during the UVLO operation, the internal circuit is operating because stopping by UVLO is not same to a stand-by mode and just switching operation is stopped.

< C_L Discharge function>

B type uses an Nch FET and resistor connected to the V_{OUT} pin to rapidly discharge the charge on the output capacitor. In order to prevent malfunction of application due to charge remaining on the output capacitor (EN="L") during stand-by.

It also operates in the UVLO detection state.

The output voltage during discharging can be calculated by the following equation.

$$V = V_{OUT(T)} \times e^{-t/\tau}$$
$$t = \tau \ln (V_{OUT(T)} / V)$$

V	: Output voltage during discharge
$V_{OUT(T)}$: Output voltage
t	: Discharge time
C_L	: Effective capacitance of Output capacitor
R_{DCHG}	: C_L auto-discharge resistance
τ	: $C_L \times R_{DCHG}$

NOTE ON USE

- 1) For the phenomenon of temporal and transitional voltage decrease or voltage increase, the IC may be damaged or deteriorated if IC is used beyond the absolute MAX. specifications. Also, if used under out of the recommended operating range, the IC may not operate normally or may cause deterioration.
- 2) Spike noise and ripple voltage arise in a switching regulator as with a DC/DC converter. These are greatly influenced by external component selection, such as the coil inductance, capacitance values, and board layout of external components. Once the design has been completed, verification with actual components should be done.
- 3) The DC/DC converter characteristics depend greatly on the externally connected components as well as on the characteristics of this IC, so refer to the specifications and standard circuit examples of each component when carefully considering which components to select. Especially for C_L capacitor, it is recommended to use an appropriate ceramic capacitor according to the DC bias usage conditions (ambient temperature, input / output voltage) so that the effective capacitance value is equal to or higher than the recommended component.
- 4) Due to propagation delay inside the product, the on time generated by the on time generation circuit is not the same as the on time that is the ratio of the input voltage to the output voltage.
- 5) The actual coil current may at times exceed the current limit value (I_{LIMH}) due to propagation delays in the current limiting circuit.
- 6) When a coil with poor DC superimposition characteristics is used, it may not be possible to draw a current of $I_{out}=600mA$ at high temperatures. In this case, either change the coil to one with a large inductance value or use a coil with better DC superimposition characteristics.
- 7) The XC9291 series may experience a drop in output voltage in heavy-load areas.
In addition, near the switching of 100% duty cycle mode in the heavy-load area, the phenomenon that the output voltage drops may occur periodically, which may increase the ripple voltage.

<Condition>

XC9291x18E ($V_{OUT(T)}=1.8V$, $f_{osc}=6MHz$)

$V_{IN}=2.5V$, $I_{OUT}=300mA$, $T_a=105^\circ C$

L : $0.47\mu H$

C_{IN} : $4.7\mu F$ (GRM035R60J475ME15)

C_L : $4.7\mu F$ (GRM035R60J475ME15)

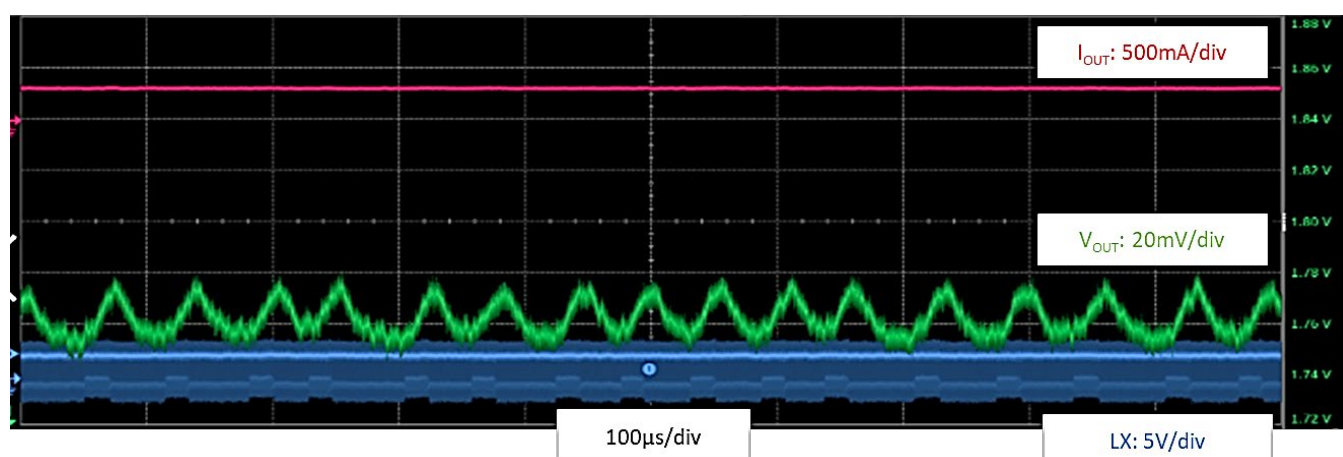

NOTE ON USE

8) At high temperatures, the leakage current of the Pch driver FET increases. Due to this leakage current, the output voltage may rise under "light load conditions of the XC9291 series (PWM/PFM automatic switching control)" and "standby state of the A type (without C_L discharge function)".

9) For the XC9290 series (PWM control), the output voltage may drop during load transient fluctuations (100mA/ μ s or more) from an output current of 300mA or more to a light load when the input/output potential difference is 1V or less.

<Condition>

XC9290x33D ($V_{OUT(T)}=3.3V$, $f_{osc}=4MHz$)

$V_{IN}=3.6V$, $I_{OUT}=370mA \rightarrow 1mA$ ($t_f=1\mu s$), $T_a=25^\circ C$

L : 2.2 μ H

C_{IN} : 4.7 μ F (GRM035R60J475ME15)

C_L : 4.7 μ F (GRM035R60J475ME15)

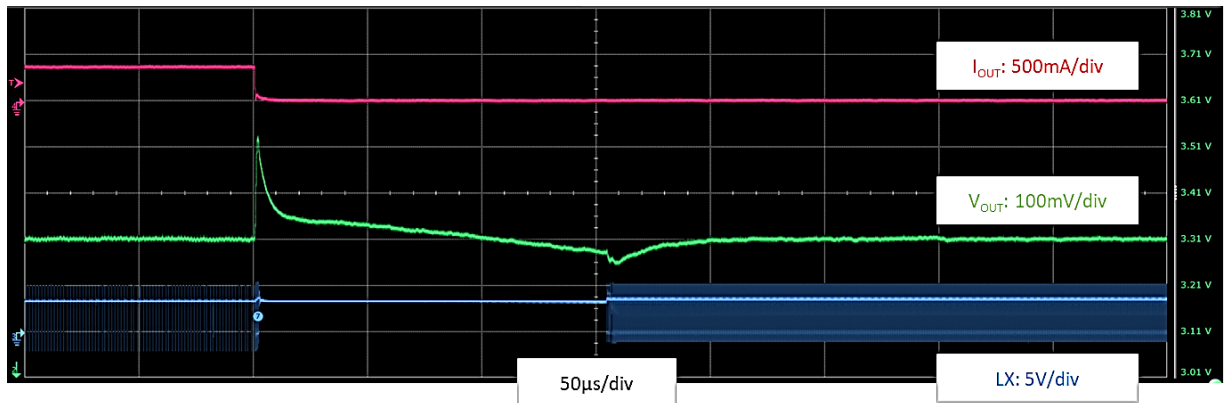

10) Torex places an importance on improving our products and their reliability. We request that users incorporate fail safe designs and post aging protection treatment when using Torex products in their systems.

■ NOTE ON USE (Continued)

11) Note on mounting (WLP)

1. Mount pad design should be optimized for user's conditions.
2. Sn-AG-Cu is used for the package terminals. If eutectic solder is used, mounting reliability is decreased. Please do not use eutectic solder paste.
3. When underfill agent is used to increase interfacial bonding strength, please take enough evaluation for selection. Some underfill materials and applied conditions may decrease bonding reliability.
4. The IC has exposed surface of silicon material in the top marking face and sides so that it is weak against mechanical damages. Please take care of handling to avoid cracks and breaks.
5. The IC has exposed surface of silicon material in the top marking face and sides. Please use the IC with keeping the circuit open (avoiding short-circuit from the out).
6. Semi-transparent resin is coated on the circuit face of the package. Please be noted that the usage under strong lights may affects device performance.

12) Instructions of pattern layouts

Especially noted in the pattern layout are as follows.

Please refer to the reference pattern layout on the next page.

1. Wire the large current line using thick, short connecting traces.
This makes it possible to reduce the wire impedance, which is expected to reduce noise and improve heat dissipation.
If the wire impedance of the large current line is large, it may cause noise or the IC to not operate normally.
2. Place the input capacitance C_{IN} , output capacitance C_L , inductor L and IC which the large current flows on the same surface. If they are placed on both sides, a large current will flow through Via, which has high impedance, it may cause noise and the IC may not operate normally.
3. Please mount each external component as close to the IC as possible.
Especially place the input capacitance C_{IN} near the IC and connect it with as low impedance as possible.
If the input capacity C_{IN} and IC are too far apart, it may cause noise or the IC may not operate normally.

NOTE ON USE (Continued)

<Reference pattern layout>

WLP-5-08

Layer 1

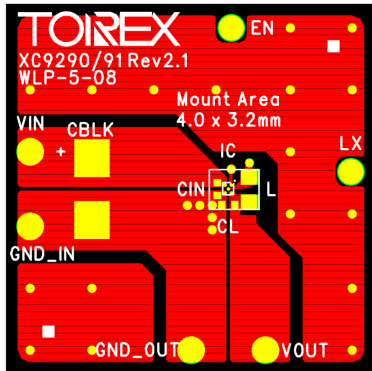

Layer 2

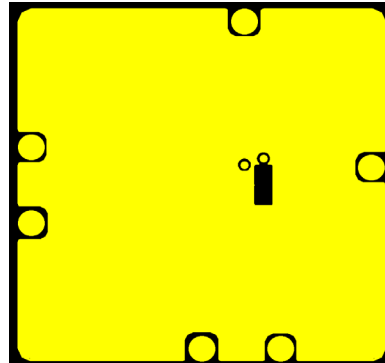

Layer 3

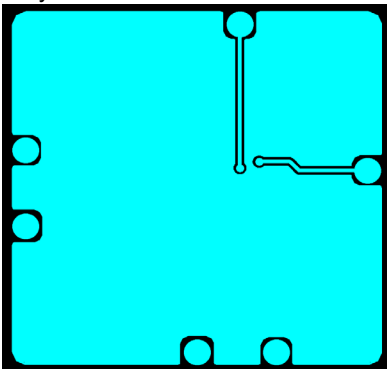

Layer 4

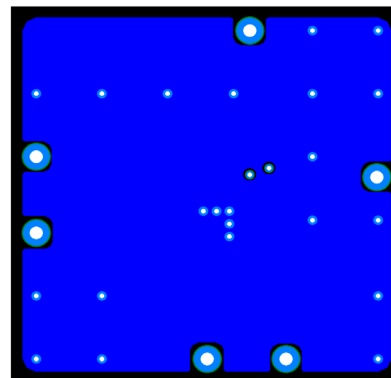

LGA-6B01

Layer 1

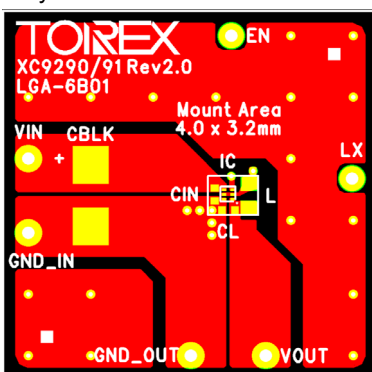

Layer 2

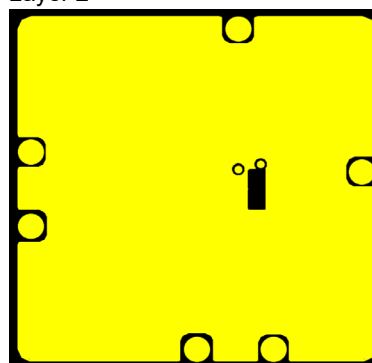

Layer 3

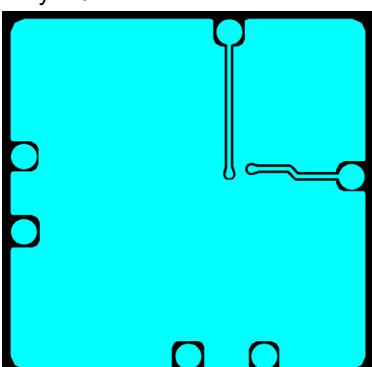

Layer 4

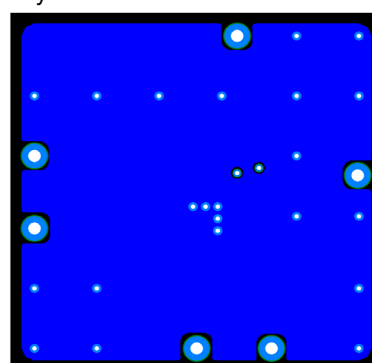

TYPICAL PERFORMANCE CHARACTERISTICS

(1) Efficiency vs. Output Current

$V_{OUT(T)}=0.8V, f_{osc}=6MHz$

$L = 0.47\mu H(DFE18SANR47MG0L)$
 $C_{IN} = 4.7\mu F(GRM035R60J475ME15)$
 $C_L = 4.7\mu F(GRM035R60J475ME15)$

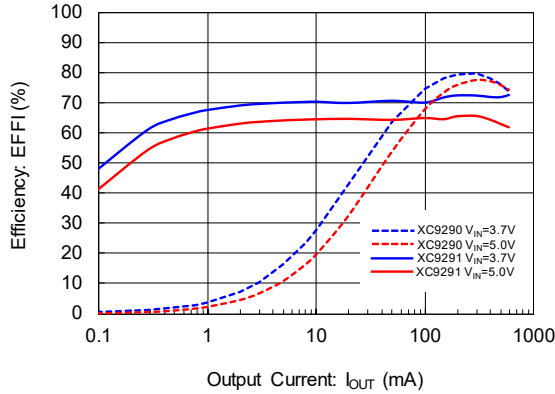

$V_{OUT(T)}=0.8V, f_{osc}=4MHz$

$L = 1.0\mu H(DFE18SAN1R0MG0L)$
 $C_{IN} = 4.7\mu F(GRM035R60J475ME15)$
 $C_L = 4.7\mu F(GRM035R60J475ME15)$

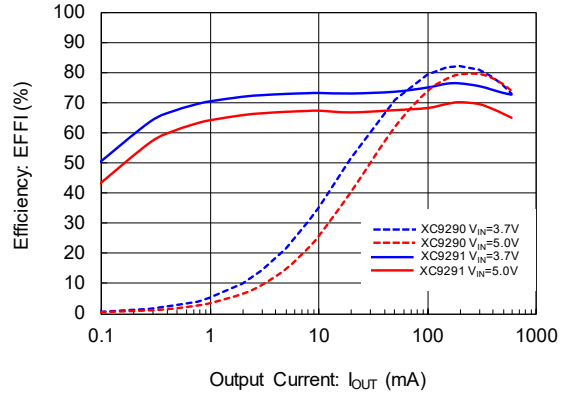

$V_{OUT(T)}=1.0V, f_{osc}=6MHz$

$L = 0.47\mu H(DFE18SANR47MG0L)$
 $C_{IN} = 4.7\mu F(GRM035R60J475ME15)$
 $C_L = 4.7\mu F(GRM035R60J475ME15)$

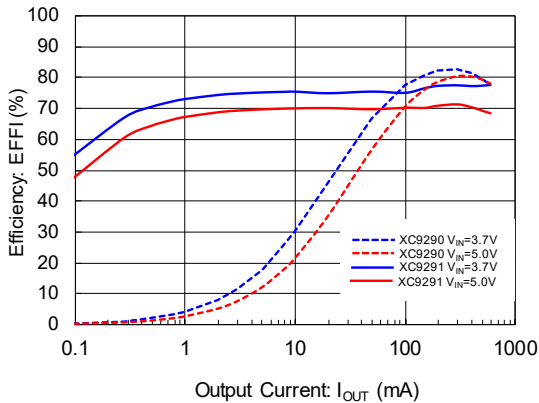

$V_{OUT(T)}=1.0V, f_{osc}=4MHz$

$L = 1.0\mu H(DFE18SAN1R0MG0L)$
 $C_{IN} = 4.7\mu F(GRM035R60J475ME15)$
 $C_L = 4.7\mu F(GRM035R60J475ME15)$

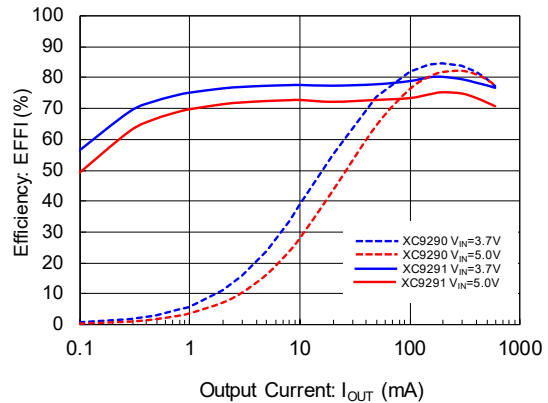

$V_{OUT(T)}=1.8V, f_{osc}=6MHz$

$L = 0.47\mu H(DFE18SANR47MG0L)$
 $C_{IN} = 4.7\mu F(GRM035R60J475ME15)$
 $C_L = 4.7\mu F(GRM035R60J475ME15)$

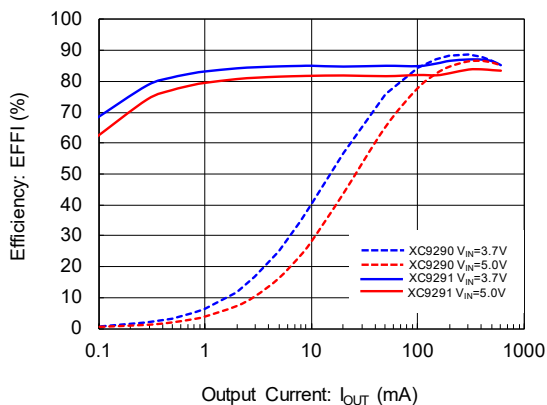

$V_{OUT(T)}=1.8V, f_{osc}=4MHz$

$L = 1.0\mu H(DFE18SAN1R0MG0L)$
 $C_{IN} = 4.7\mu F(GRM035R60J475ME15)$
 $C_L = 4.7\mu F(GRM035R60J475ME15)$

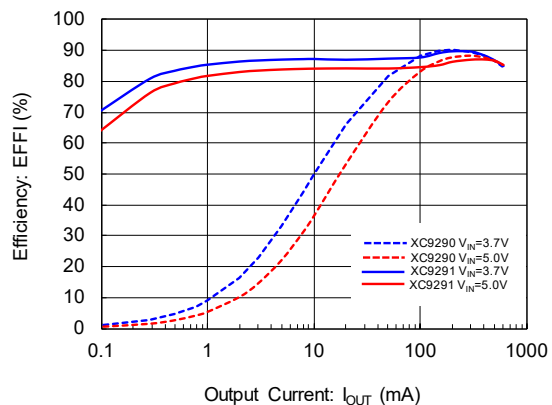

TYPICAL PERFORMANCE CHARACTERISTICS

(1) Efficiency vs. Output Current (Continued)

$V_{OUT(T)}=3.3V$, $f_{OSC}=6MHz$

$L = 0.47\mu H(DFE18SANR47MG0L)$
 $C_{IN} = 4.7\mu F(GRM035R60J475ME15)$
 $C_L = 4.7\mu F(GRM035R60J475ME15)$

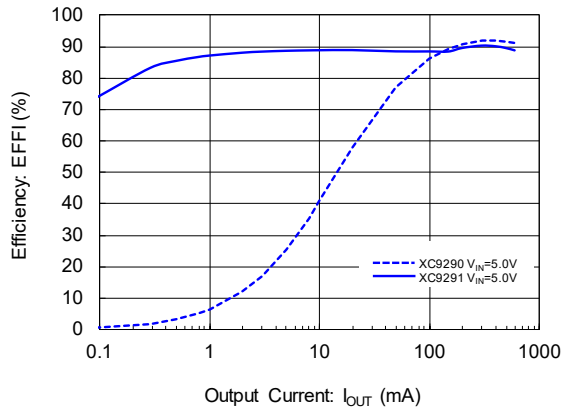

$V_{OUT(T)}=3.3V$, $f_{OSC}=4MHz$

$L = 1.0\mu H(DFE18SAN1R0MG0L)$
 $C_{IN} = 4.7\mu F(GRM035R60J475ME15)$
 $C_L = 4.7\mu F(GRM035R60J475ME15)$

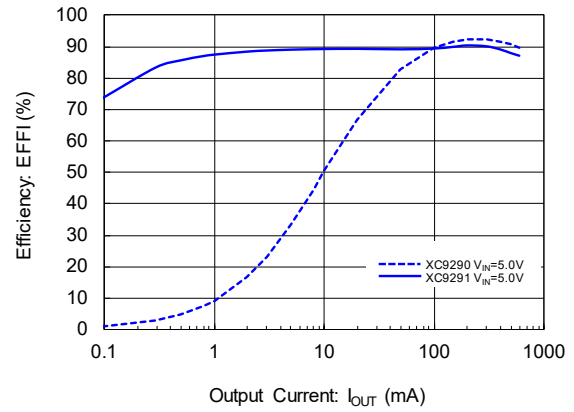

TYPICAL PERFORMANCE CHARACTERISTICS

(2) Output Voltage vs. Output Current

XC9290B12E($V_{OUT(T)}=1.2V$, $f_{OSC}=6MHz$)

$L = 0.47\mu H$ (DFE18SANR47MG0L)
 $C_{IN} = 4.7\mu F$ (GRM035R60J475ME15)
 $C_L = 4.7\mu F$ (GRM035R60J475ME15)

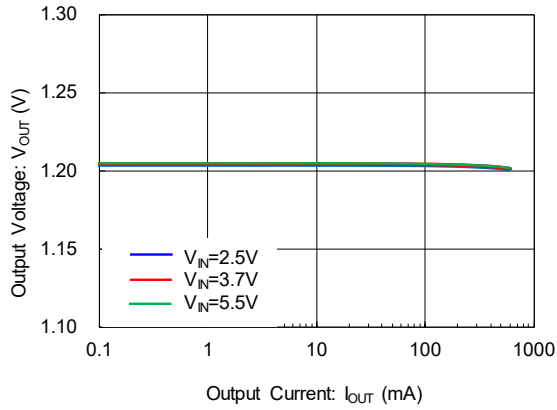

XC9290B12D($V_{OUT(T)}=1.2V$, $f_{OSC}=4MHz$)

$L = 1.0\mu H$ (DFE18SAN1R0MG0L)
 $C_{IN} = 4.7\mu F$ (GRM035R60J475ME15)
 $C_L = 4.7\mu F$ (GRM035R60J475ME15)

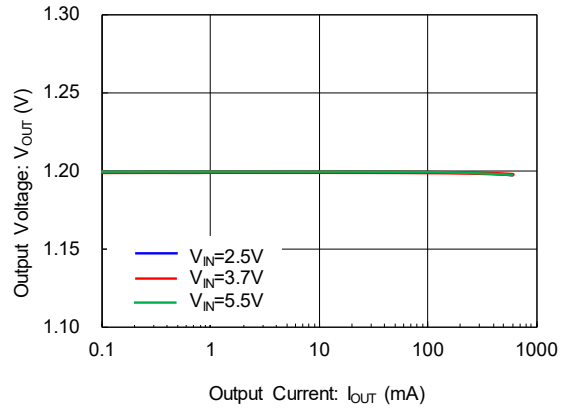

XC9291B12E($V_{OUT(T)}=1.2V$, $f_{OSC}=6MHz$)

$L = 0.47\mu H$ (DFE18SANR47MG0L)
 $C_{IN} = 4.7\mu F$ (GRM035R60J475ME15)
 $C_L = 4.7\mu F$ (GRM035R60J475ME15)

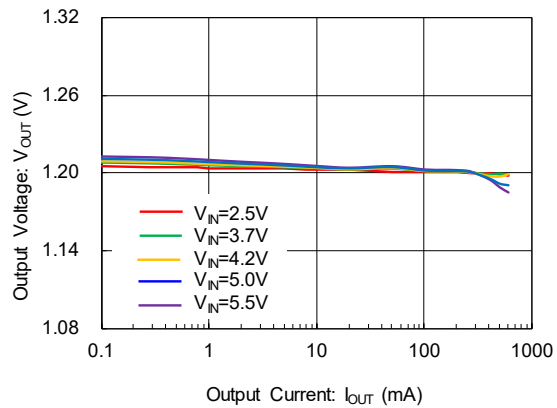

XC9291B12D($V_{OUT(T)}=1.2V$, $f_{OSC}=4MHz$)

$L = 1.0\mu H$ (DFE18SAN1R0MG0L)
 $C_{IN} = 4.7\mu F$ (GRM035R60J475ME15)
 $C_L = 4.7\mu F$ (GRM035R60J475ME15)

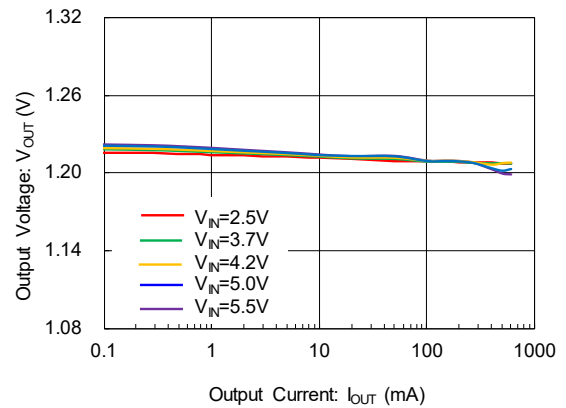

XC9290B18E($V_{OUT(T)}=1.8V$, $f_{OSC}=6MHz$)

$L = 0.47\mu H$ (DFE18SANR47MG0L)
 $C_{IN} = 4.7\mu F$ (GRM035R60J475ME15)
 $C_L = 4.7\mu F$ (GRM035R60J475ME15)

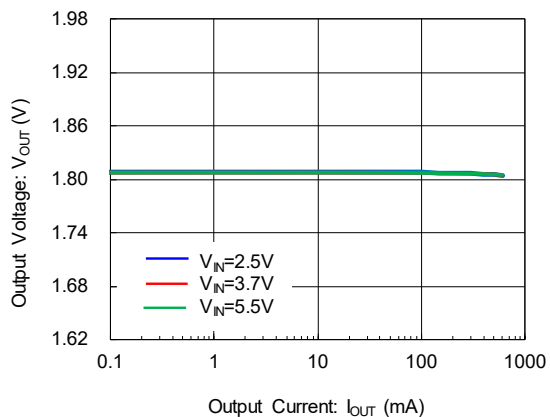

XC9290B18D($V_{OUT(T)}=1.8V$, $f_{OSC}=4MHz$)

$L = 1.0\mu H$ (DFE18SAN1R0MG0L)
 $C_{IN} = 4.7\mu F$ (GRM035R60J475ME15)
 $C_L = 4.7\mu F$ (GRM035R60J475ME15)

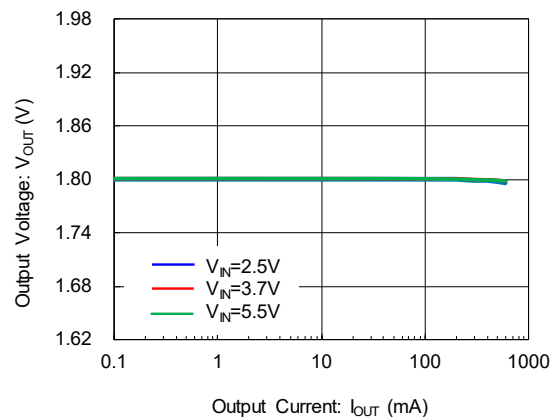

TYPICAL PERFORMANCE CHARACTERISTICS

(2) Output Voltage vs. Output Current (Continued)

XC9291B18E ($V_{OUT(T)}=1.8V$, $f_{OSC}=6MHz$)
 $L = 0.47\mu H$ (DFE18SANR47MG0L)
 $C_{IN} = 4.7\mu F$ (GRM035R60J475ME15)
 $C_L = 4.7\mu F$ (GRM035R60J475ME15)

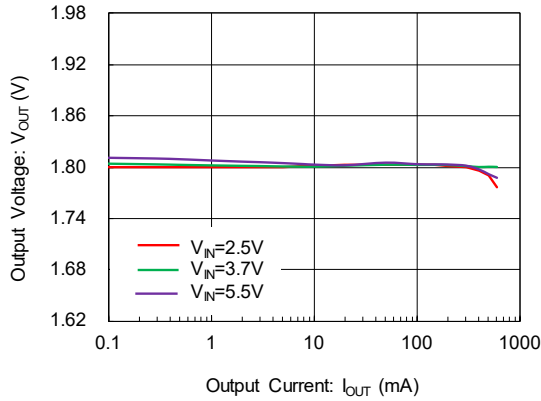

XC9291B18D ($V_{OUT(T)}=1.8V$, $f_{OSC}=4MHz$)
 $L = 1.0\mu H$ (DFE18SAN1R0MG0L)
 $C_{IN} = 4.7\mu F$ (GRM035R60J475ME15)
 $C_L = 4.7\mu F$ (GRM035R60J475ME15)

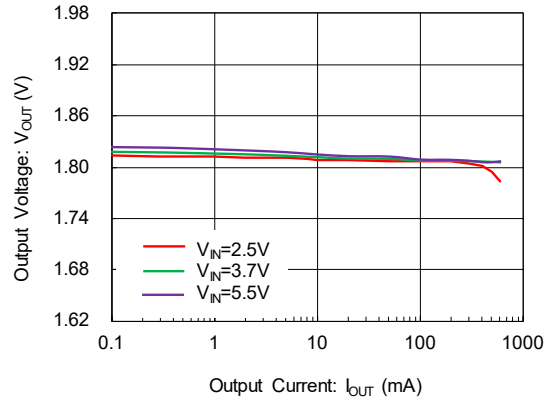

XC9290B33E ($V_{OUT(T)}=3.3V$, $f_{OSC}=6MHz$)
 $L = 0.47\mu H$ (DFE18SANR47MG0L)
 $C_{IN} = 4.7\mu F$ (GRM035R60J475ME15)
 $C_L = 4.7\mu F$ (GRM035R60J475ME15)

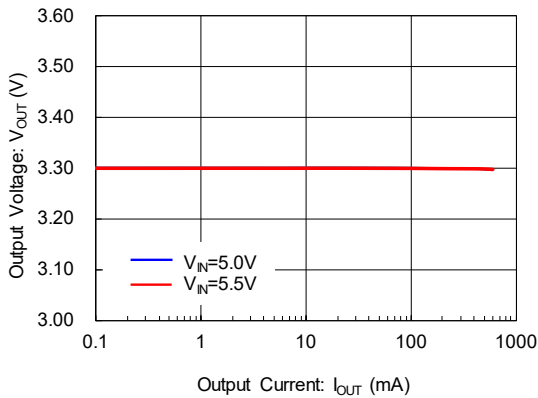

XC9290B33D ($V_{OUT(T)}=3.3V$, $f_{OSC}=4MHz$)
 $L = 1.0\mu H$ (DFE18SAN1R0MG0L)
 $C_{IN} = 4.7\mu F$ (GRM035R60J475ME15)
 $C_L = 4.7\mu F$ (GRM035R60J475ME15)

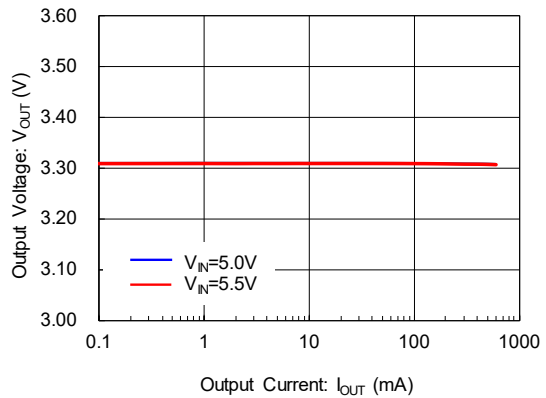

XC9291B33E ($V_{OUT(T)}=3.3V$, $f_{OSC}=6MHz$)
 $L = 0.47\mu H$ (DFE18SANR47MG0L)
 $C_{IN} = 4.7\mu F$ (GRM035R60J475ME15)
 $C_L = 4.7\mu F$ (GRM035R60J475ME15)

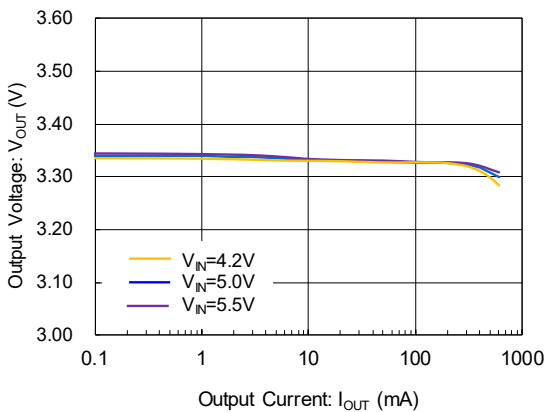

XC9291B33D ($V_{OUT(T)}=3.3V$, $f_{OSC}=4MHz$)
 $L = 1.0\mu H$ (DFE18SAN1R0MG0L)
 $C_{IN} = 4.7\mu F$ (GRM035R60J475ME15)
 $C_L = 4.7\mu F$ (GRM035R60J475ME15)

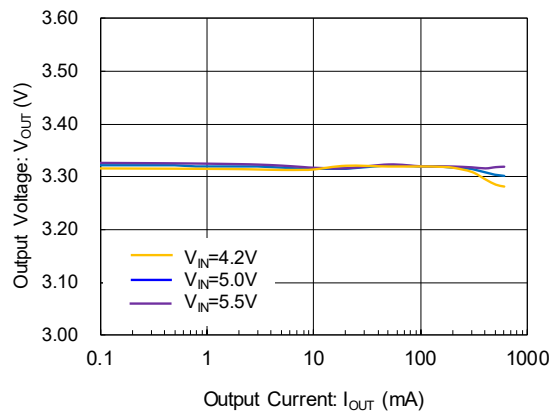

TYPICAL PERFORMANCE CHARACTERISTICS

(3) Ripple Voltage vs. Output Current

$V_{OUT(T)}=1.0V, f_{OSC}=6MHz$
 $L = 0.47\mu H(LSCNB1005EETR47MB)$
 $C_{IN} = 4.7\mu F(GRM035R60J475ME15)$
 $C_L = 4.7\mu F(C1005X5R0J475K)$

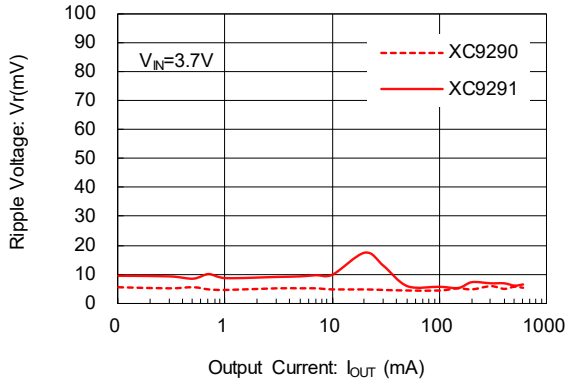

$V_{OUT(T)}=1.0V, f_{OSC}=4MHz$
 $L = 1.0\mu H(LSCNB1005EET1R0MB)$
 $C_{IN} = 4.7\mu F(GRM035R60J475ME15)$
 $C_L = 4.7\mu F(C1005X5R0J475K)$

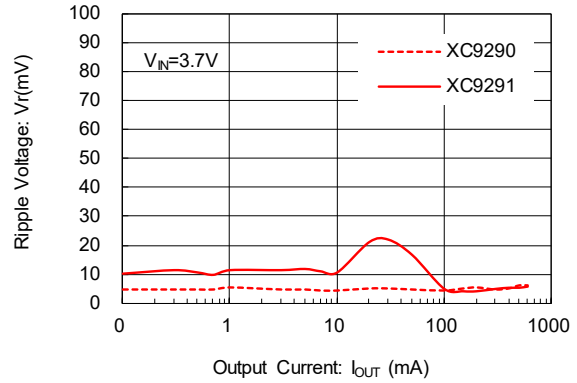

$V_{OUT(T)}=1.8V, f_{OSC}=6MHz$
 $L = 0.47\mu H(LSCNB1005EETR47MB)$
 $C_{IN} = 4.7\mu F(GRM035R60J475ME15)$
 $C_L = 4.7\mu F(C1005X5R0J475K)$

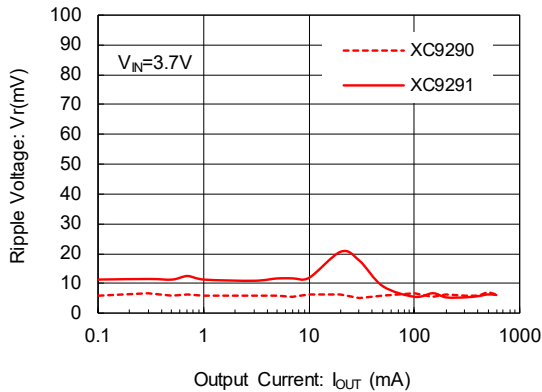

$V_{OUT(T)}=1.8V, f_{OSC}=4MHz$
 $L = 1.0\mu H(LSCNB1005EET1R0MB)$
 $C_{IN} = 4.7\mu F(GRM035R60J475ME15)$
 $C_L = 4.7\mu F(C1005X5R0J475M050BC)$

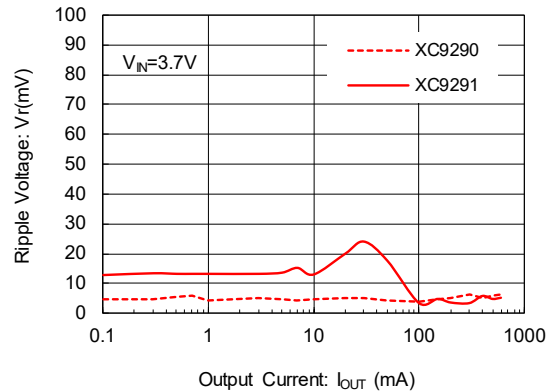

$V_{OUT(T)}=3.3V, f_{OSC}=6MHz$
 $L = 0.47\mu H(LSCNB1005EETR47MB)$
 $C_{IN} = 4.7\mu F(GRM035R60J475ME15)$
 $C_L = 4.7\mu F(C1005X5R0J475K)$

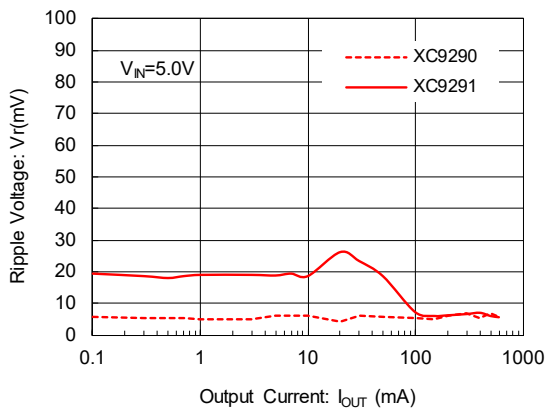

$V_{OUT(T)}=3.3V, f_{OSC}=4MHz$
 $L = 1.0\mu H(LSCNB1005EET1R0MB)$
 $C_{IN} = 4.7\mu F(GRM035R60J475ME15)$
 $C_L = 4.7\mu F(C1005X5R0J475K)$

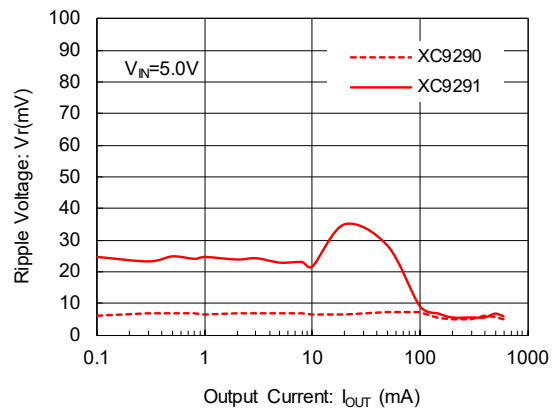

TYPICAL PERFORMANCE CHARACTERISTICS

(4) Output Voltage vs. Ambient Temperature

$$V_{OUT(T)}=1.8V$$

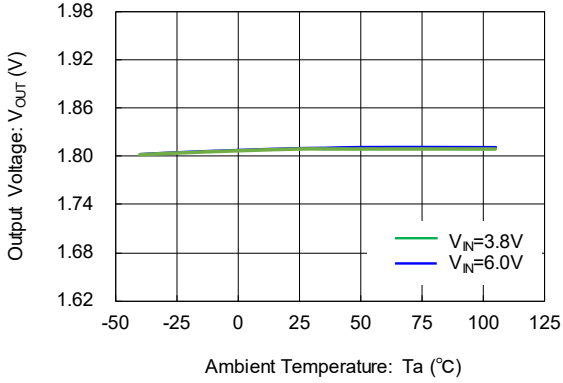

(5) UVLO Voltage vs. Ambient Temperature

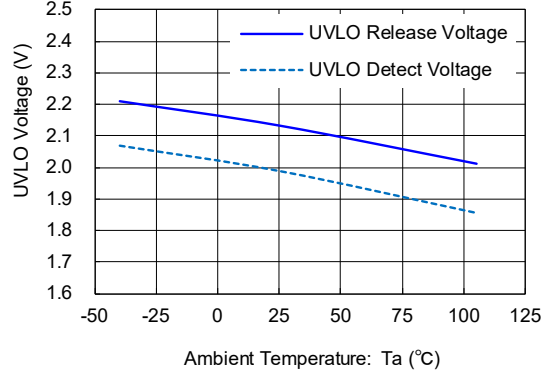

(6) Quiescent Current vs. Ambient Temperature

XC9290

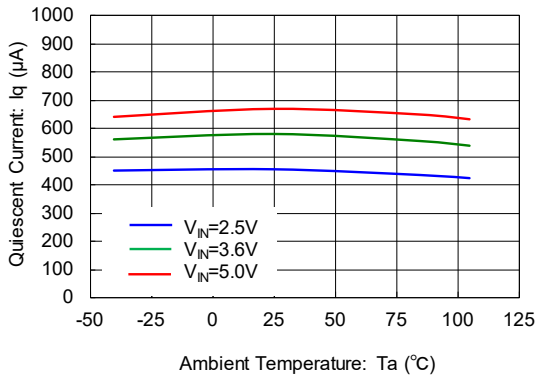

XC9291

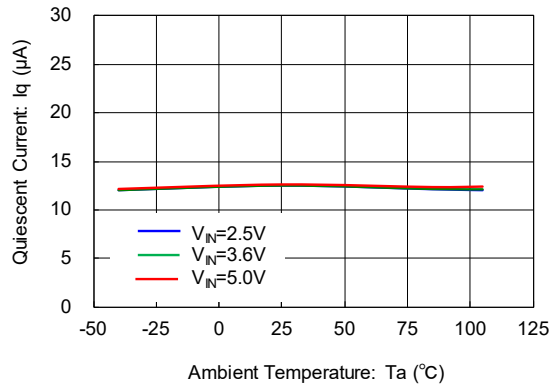

(7) Stand-by Current vs. Ambient Temperature

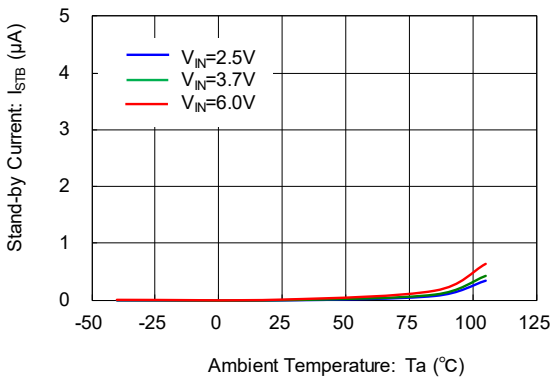

TYPICAL PERFORMANCE CHARACTERISTICS

(8) Oscillation Frequency vs. Output Current

XC9290B08E ($V_{OUT(T)}=0.8V$, $f_{OSC}=6MHz$)

$L = 0.47\mu H$ (DFE18SANR47MG0L)
 $C_{IN} = 4.7\mu F$ (GRM035R60J475ME15)
 $C_L = 4.7\mu F$ (GRM035R60J475ME15)

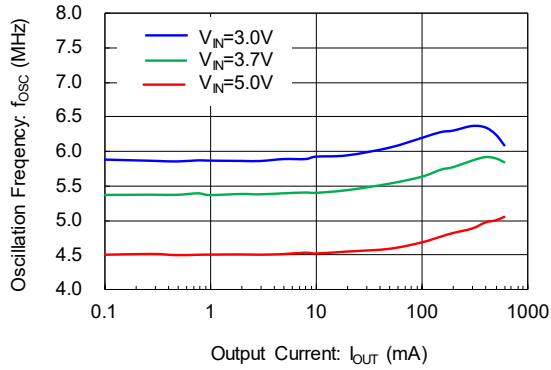

XC9290B18E ($V_{OUT(T)}=1.8V$, $f_{OSC}=6MHz$)

$L = 0.47\mu H$ (DFE18SANR47MG0L)
 $C_{IN} = 4.7\mu F$ (GRM035R60J475ME15)
 $C_L = 4.7\mu F$ (GRM035R60J475ME15)

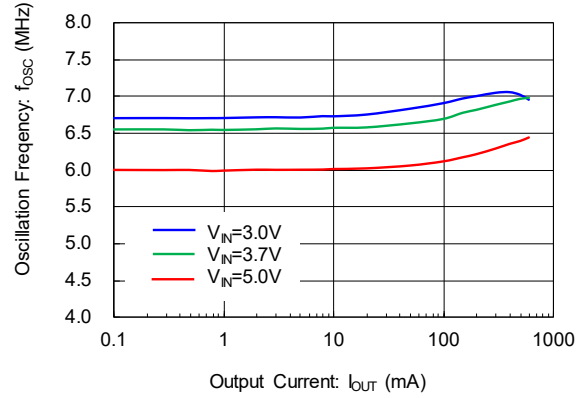

XC9290B33E ($V_{OUT(T)}=3.3V$, $f_{OSC}=6MHz$)

$L = 0.47\mu H$ (DFE18SANR47MG0L)
 $C_{IN} = 4.7\mu F$ (GRM035R60J475ME15)
 $C_L = 4.7\mu F$ (GRM035R60J475ME15)

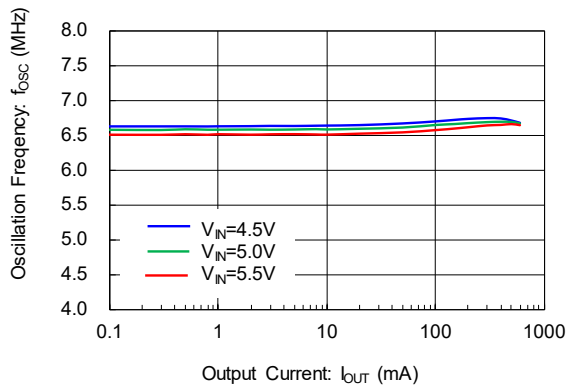

TYPICAL PERFORMANCE CHARACTERISTICS

(8) Oscillation Frequency vs. Output Current (Continued)

XC9290B08D ($V_{OUT(T)}=0.8V$, $f_{OSC}=4MHz$)

$L = 1.0\mu H$ (DFE18SAN1R0MG0L)
 $C_{IN} = 4.7\mu F$ (GRM035R60J475ME15)
 $C_L = 4.7\mu F$ (GRM035R60J475ME15)

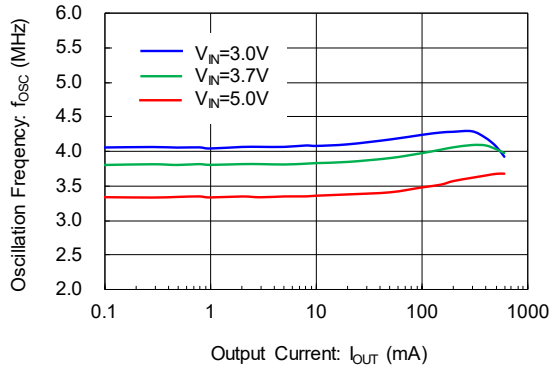

XC9290B18D ($V_{OUT(T)}=1.8V$, $f_{OSC}=4MHz$)

$L = 1.0\mu H$ (DFE18SAN1R0MG0L)
 $C_{IN} = 4.7\mu F$ (GRM035R60J475ME15)
 $C_L = 4.7\mu F$ (GRM035R60J475ME15)

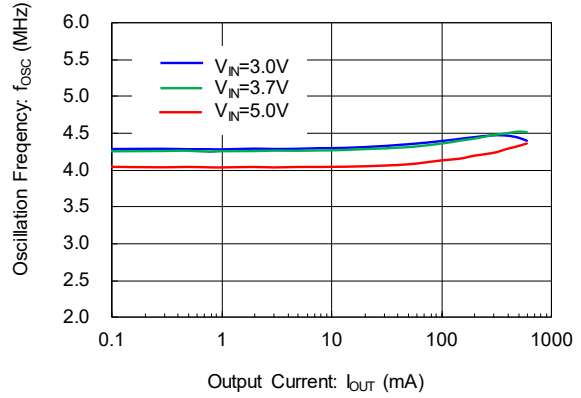

XC9290B33D ($V_{OUT(T)}=3.3V$, $f_{OSC}=4MHz$)

$L = 1.0\mu H$ (DFE18SAN1R0MG0L)
 $C_{IN} = 4.7\mu F$ (GRM035R60J475ME15)
 $C_L = 4.7\mu F$ (GRM035R60J475ME15)

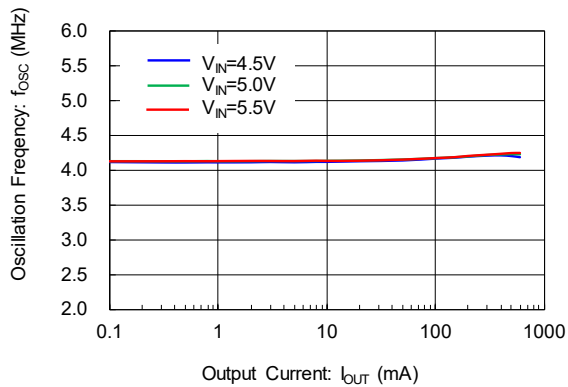

TYPICAL PERFORMANCE CHARACTERISTICS

(9) Lx SW "H" ON Resistance vs. Ambient Temperature

(10) Lx SW "L" ON Resistance vs. Ambient Temperature

Package : WLP-5-08

Package : WLP-5-08

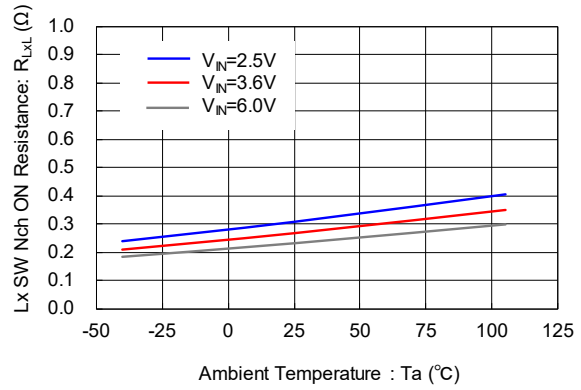
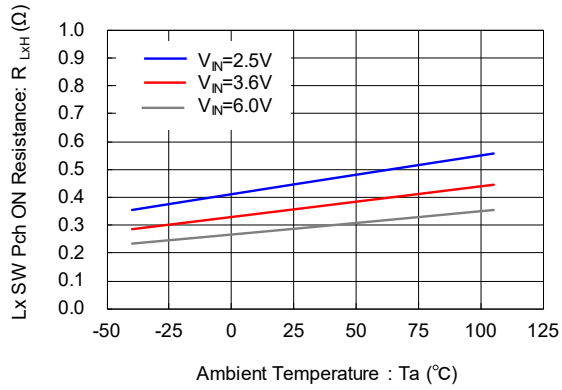

(11) Lx SW "H" Leakage Current vs. Ambient Temperature

(12) Lx SW "L" Leakage Current vs. Ambient Temperature

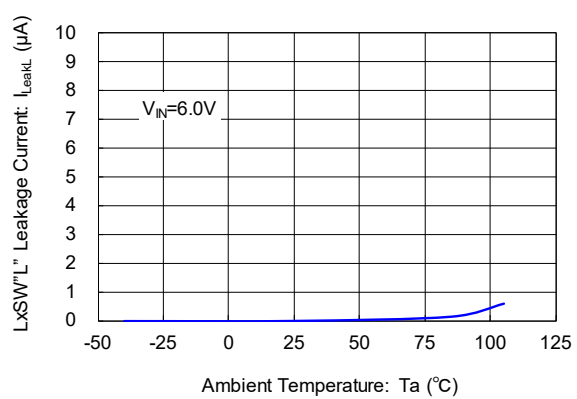
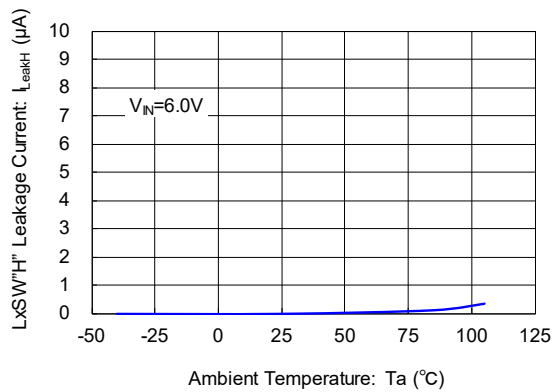

(13) EN "H" Voltage vs. Ambient Temperature

(14) EN "L" Voltage vs. Ambient Temperature

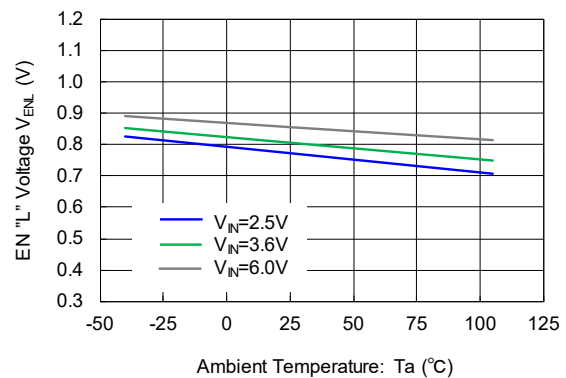
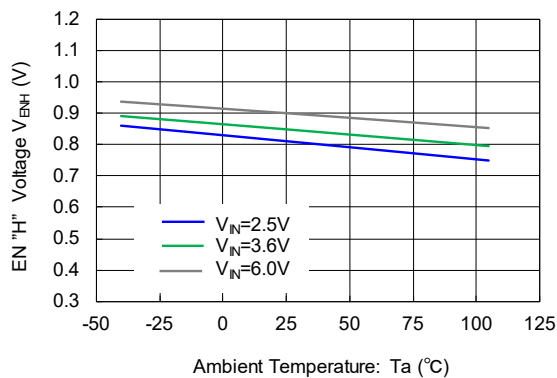

TYPICAL PERFORMANCE CHARACTERISTICS

(15) Current Limit vs. Ambient Temperature

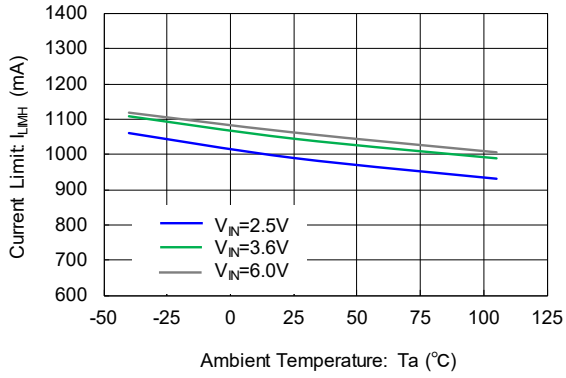

(16) Soft-Start Time vs. Ambient Temperature

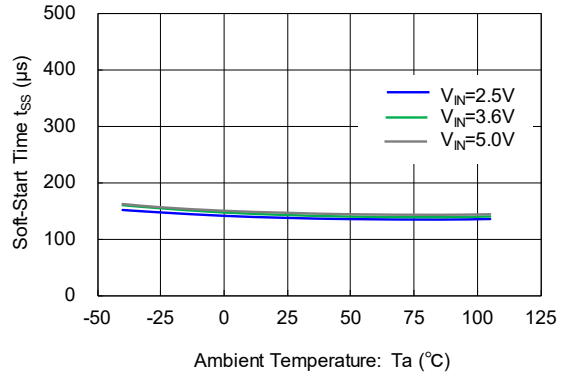

(17) C_L Discharge Resistance vs. Ambient Temperature

XC9290B/XC9291B ($V_{OUT}=1.0V$)

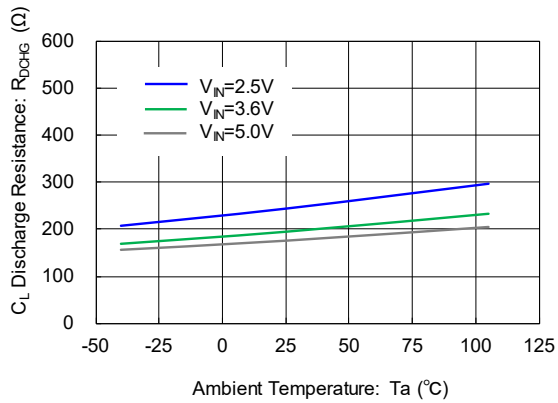

TYPICAL PERFORMANCE CHARACTERISTICS

(18) Load Transient Responses

XC9290x10E ($V_{OUT(T)} = 1.0V$, $f_{OSC} = 6MHz$)
 $V_{IN} = 5.0V$
 $I_{OUT} = 1mA \leftrightarrow 300mA$ ($t_r, t_f = 5\mu s$)
 $L = 0.47\mu H$ (LSCNB1005EETR47MB)
 $C_{IN} = 4.7\mu F$ (GRM035R60J475ME15)
 $C_L = 4.7\mu F$ (C1005X5R0J475K)

XC9291x10E ($V_{OUT(T)} = 1.0V$, $f_{OSC} = 6MHz$)
 $V_{IN} = 5.0V$
 $I_{OUT} = 1mA \leftrightarrow 300mA$ ($t_r, t_f = 5\mu s$)
 $L = 0.47\mu H$ (LSCNB1005EETR47MB)
 $C_{IN} = 4.7\mu F$ (GRM035R60J475ME15)
 $C_L = 4.7\mu F$ (C1005X5R0J475K)

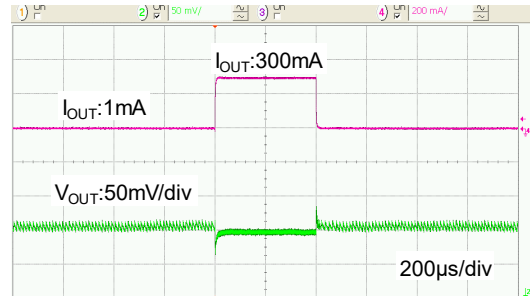
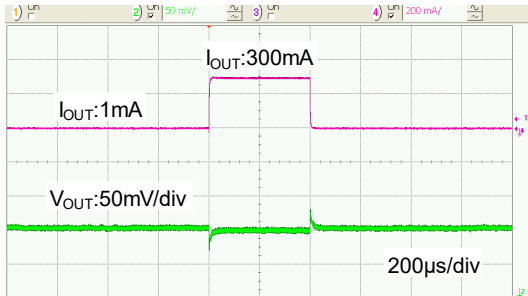

XC9290x18E ($V_{OUT(T)} = 1.8V$, $f_{OSC} = 6MHz$)
 $V_{IN} = 5.0V$
 $I_{OUT} = 1mA \leftrightarrow 300mA$ ($t_r, t_f = 5\mu s$)
 $L = 0.47\mu H$ (LSCNB1005EETR47MB)
 $C_{IN} = 4.7\mu F$ (GRM035R60J475ME15)
 $C_L = 4.7\mu F$ (C1005X5R0J475K)

XC9291x18E ($V_{OUT(T)} = 1.8V$, $f_{OSC} = 6MHz$)
 $V_{IN} = 5.0V$
 $I_{OUT} = 1mA \leftrightarrow 300mA$ ($t_r, t_f = 5\mu s$)
 $L = 0.47\mu H$ (LSCNB1005EETR47MB)
 $C_{IN} = 4.7\mu F$ (GRM035R60J475ME15)
 $C_L = 4.7\mu F$ (C1005X5R0J475K)

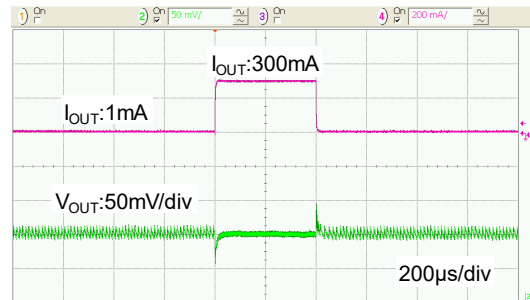
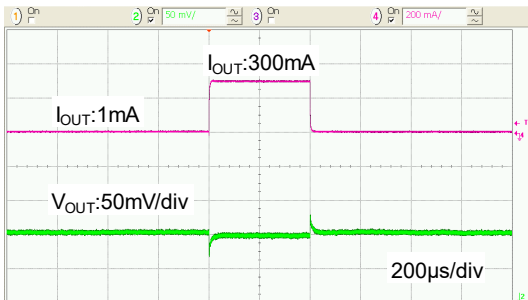

XC9290x33E ($V_{OUT(T)} = 3.3V$, $f_{OSC} = 6MHz$)
 $V_{IN} = 5.0V$
 $I_{OUT} = 1mA \leftrightarrow 300mA$ ($t_r, t_f = 5\mu s$)
 $L = 0.47\mu H$ (LSCNB1005EETR47MB)
 $C_{IN} = 4.7\mu F$ (GRM035R60J475ME15)
 $C_L = 4.7\mu F$ (C1005X5R0J475K)

XC9291x33E ($V_{OUT(T)} = 3.3V$, $f_{OSC} = 6MHz$)
 $V_{IN} = 5.0V$
 $I_{OUT} = 1mA \leftrightarrow 300mA$ ($t_r, t_f = 5\mu s$)
 $L = 0.47\mu H$ (LSCNB1005EETR47MB)
 $C_{IN} = 4.7\mu F$ (GRM035R60J475ME15)
 $C_L = 4.7\mu F$ (C1005X5R0J475K)

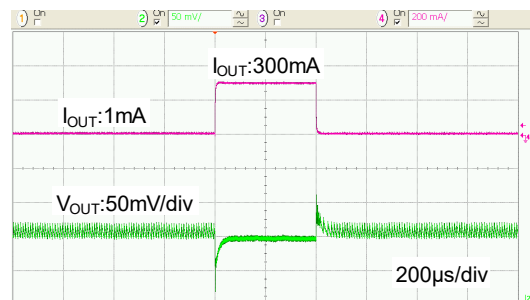
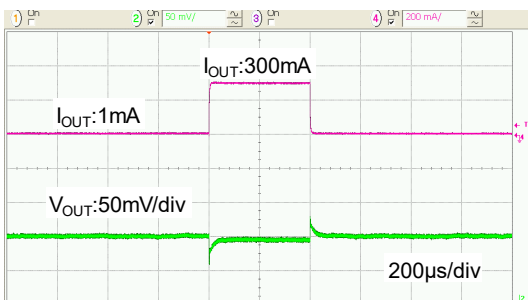

TYPICAL PERFORMANCE CHARACTERISTICS

(18) Load Transient Responses(Continued)

XC9290x10D ($V_{OUT(T)} = 1.0V$, $f_{OSC} = 4MHz$)
 $V_{IN} = 5.0V$
 $I_{OUT} = 1mA \leftrightarrow 300mA$ ($t_r, t_f = 5\mu s$)
 $L = 1.0\mu H$ (LSCNB1005EET1R0MB)
 $C_{IN} = 4.7\mu F$ (GRM035R60J475ME15)
 $C_L = 4.7\mu F$ (C1005X5R0J475K)

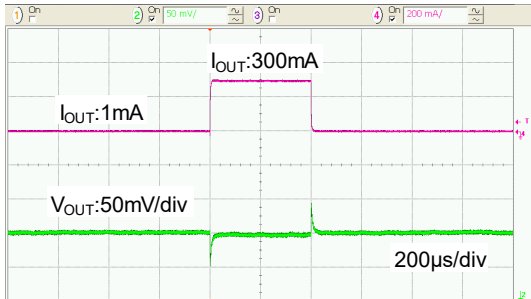

XC9291x10D ($V_{OUT(T)} = 1.0V$, $f_{OSC} = 4MHz$)
 $V_{IN} = 5.0V$
 $I_{OUT} = 1mA \leftrightarrow 300mA$ ($t_r, t_f = 5\mu s$)
 $L = 1.0\mu H$ (LSCNB1005EET1R0MB)
 $C_{IN} = 4.7\mu F$ (GRM035R60J475ME15)
 $C_L = 4.7\mu F$ (C1005X5R0J475K)

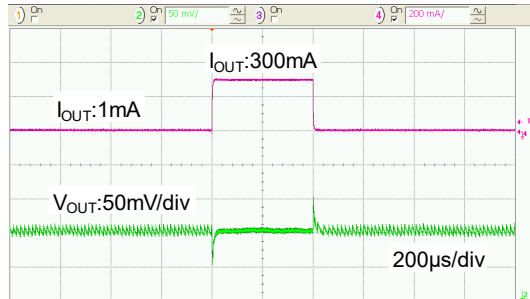

XC9290x18D ($V_{OUT(T)} = 1.8V$, $f_{OSC} = 4MHz$)
 $V_{IN} = 5.0V$
 $I_{OUT} = 1mA \leftrightarrow 300mA$ ($t_r, t_f = 5\mu s$)
 $L = 1.0\mu H$ (LSCNB1005EET1R0MB)
 $C_{IN} = 4.7\mu F$ (GRM035R60J475ME15)
 $C_L = 4.7\mu F$ (C1005X5R0J475K)

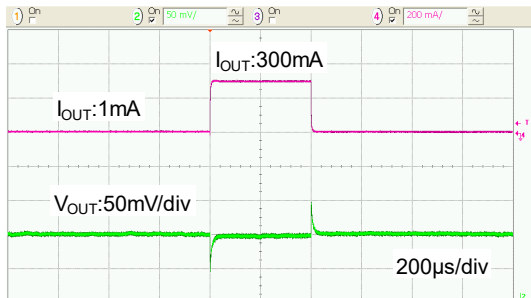

XC9291x18D ($V_{OUT(T)} = 1.8V$, $f_{OSC} = 4MHz$)
 $V_{IN} = 5.0V$
 $I_{OUT} = 1mA \leftrightarrow 300mA$ ($t_r, t_f = 5\mu s$)
 $L = 1.0\mu H$ (LSCNB1005EET1R0MB)
 $C_{IN} = 4.7\mu F$ (GRM035R60J475ME15)
 $C_L = 4.7\mu F$ (C1005X5R0J475K)

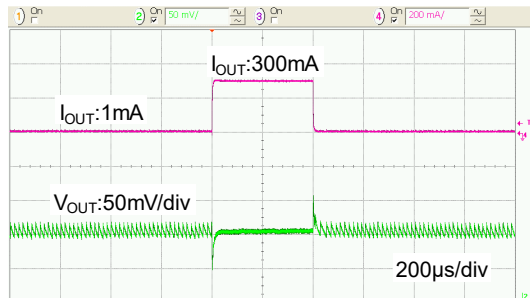

XC9290x33D ($V_{OUT(T)} = 3.3V$, $f_{OSC} = 4MHz$)
 $V_{IN} = 5.0V$
 $I_{OUT} = 1mA \leftrightarrow 300mA$ ($t_r, t_f = 5\mu s$)
 $L = 1.0\mu H$ (LSCNB1005EET1R0MB)
 $C_{IN} = 4.7\mu F$ (GRM035R60J475ME15)
 $C_L = 4.7\mu F$ (C1005X5R0J475K)

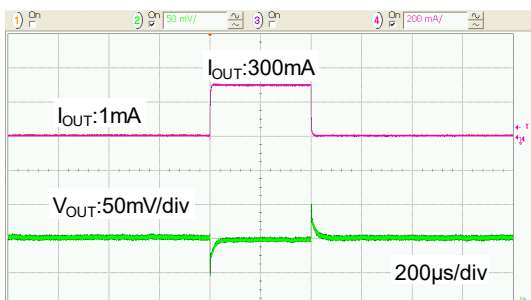

XC9291x33D ($V_{OUT(T)} = 3.3V$, $f_{OSC} = 4MHz$)
 $V_{IN} = 5.0V$
 $I_{OUT} = 1mA \leftrightarrow 300mA$ ($t_r, t_f = 5\mu s$)
 $L = 1.0\mu H$ (LSCNB1005EET1R0MB)
 $C_{IN} = 4.7\mu F$ (GRM035R60J475ME15)
 $C_L = 4.7\mu F$ (C1005X5R0J475K)

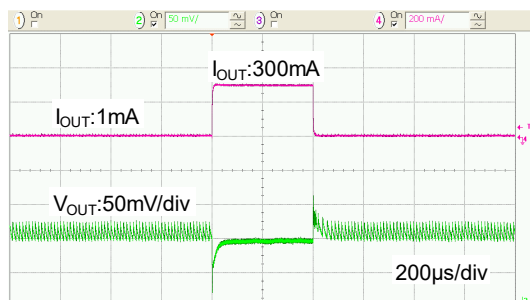

TYPICAL PERFORMANCE CHARACTERISTICS

(19) Start-up

XC9290x18E ($V_{OUT(T)} = 1.8V$, $f_{OSC} = 6MHz$)
 $V_{IN} = 3.6V$
 $V_{EN} = 0.0V \Rightarrow 5.0V$
 $L = 0.47\mu H$ (LSCNB1005EETR47MB)
 $C_{IN} = 4.7\mu F$ (GRM035R60J475ME15)
 $C_L = 4.7\mu F$ (GRM035R60J475ME15)
 Load = 1.8k Ω

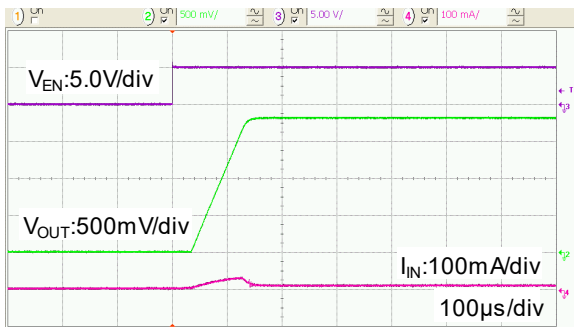

XC9291x18E ($V_{OUT(T)} = 1.8V$, $f_{OSC} = 6MHz$)
 $V_{IN} = 3.6V$
 $V_{EN} = 0.0V \Rightarrow 5.0V$
 $L = 0.47\mu H$ (LSCNB1005EETR47MB)
 $C_{IN} = 4.7\mu F$ (GRM035R60J475ME15)
 $C_L = 4.7\mu F$ (GRM035R60J475ME15)
 Load = 1.8k Ω

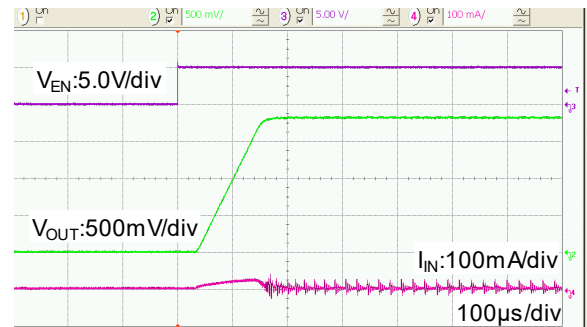

(20-1) Shutdown (Without C_L discharge function)

XC9291A18E ($V_{OUT(T)} = 1.8V$, $f_{OSC} = 6MHz$)
 $V_{IN} = 3.6V$
 $V_{EN} = 5.0V \Rightarrow 0.0V$
 $L = 0.47\mu H$ (LSCNB1005EETR47MB)
 $C_{IN} = 4.7\mu F$ (GRM035R60J475ME15)
 $C_L = 4.7\mu F$ (GRM035R60J475ME15)
 Load = 1.8k Ω

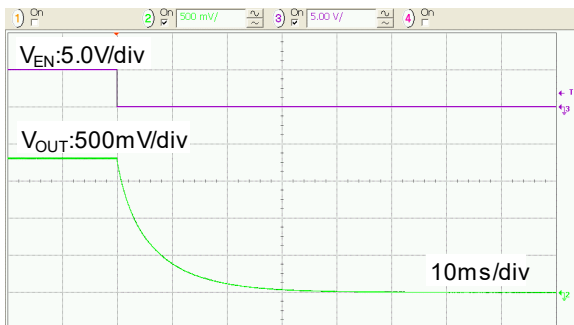

(20-2) Shutdown (With C_L discharge function)

XC9291B18E ($V_{OUT(T)} = 1.8V$, $f_{OSC} = 6MHz$)
 $V_{IN} = 3.6V$
 $V_{EN} = 5.0V \Rightarrow 0.0V$
 $L = 0.47\mu H$ (LSCNB1005EETR47MB)
 $C_{IN} = 4.7\mu F$ (GRM035R60J475ME15)
 $C_L = 4.7\mu F$ (GRM035R60J475ME15)
 Load = 1.8k Ω

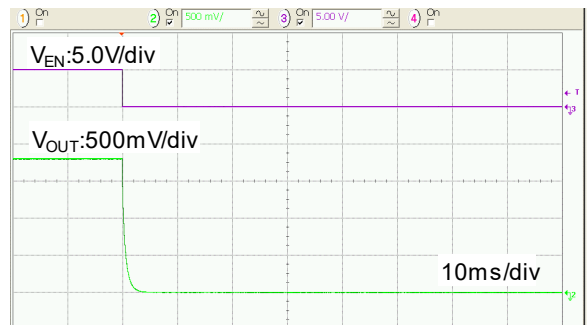

■ PACKAGING INFORMATION

For the latest package information go to, www.torexsemi.com/technical-support/packages

PACKAGE	OUTLINE / LAND PATTERN	THERMAL CHARACTERISTICS
LGA-6B01	LGA-6B01 PKG	LGA-6B01 Power Dissipation
WLP-5-08	WLP-5-08 PKG	WLP-5-08 Power Dissipation

MARKING RULE

① represents products series

MARK	PRODUCT SERIES
F	XC9290*****_G
H	XC9291*****_G

LGA-6B01

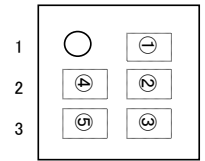

② represents type, Oscillation Frequency, and the second decimal place of the output voltage

MARK	Oscillation Frequency	PRODUCT SERIES
A	6.0MHz	XC929*A*0E**-G ~ XC929*A*9E**-G
B		XC929*B*0E**-G ~ XC929*B*9E**-G
C		XC929*A*AE**-G ~ XC929*A*ME**-G
D		XC929*B*AE**-G ~ XC929*B*ME**-G
E	4.0MHz	XC929*A*0D**-G ~ XC929*A*9D**-G
F		XC929*B*0D**-G ~ XC929*B*9D**-G
H		XC929*A*AD**-G ~ XC929*A*MD**-G
K		XC929*B*AD**-G ~ XC929*B*MD**-G

WLP-5-08

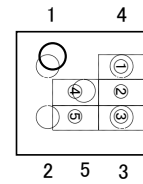

③ represents output voltage

MARK	OUTPUT VOLTAGE (V)		PRODUCT SERIES	MARK	OUTPUT VOLTAGE (V)		PRODUCT SERIES
0	0.7	0.75	XC929**07/0K***-G	F	2.2	2.25	XC929**22/2C***-G
1	0.8	0.85	XC929**08/0L***-G	H	2.3	2.35	XC929**23/2D***-G
2	0.9	0.95	XC929**09/0M***-G	K	2.4	2.45	XC929**24/2E***-G
3	1.0	1.05	XC929**10/1A***-G	L	2.5	2.55	XC929**25/2F***-G
4	1.1	1.15	XC929**11/1B***-G	M	2.6	2.65	XC929**26/2H***-G
5	1.2	1.25	XC929**12/1C***-G	N	2.7	2.75	XC929**27/2K***-G
6	1.3	1.35	XC929**13/1D***-G	P	2.8	2.85	XC929**28/2L***-G
7	1.4	1.45	XC929**14/1E***-G	R	2.9	2.95	XC929**29/2M***-G
8	1.5	1.55	XC929**15/1F***-G	S	3.0	3.05	XC929**30/3A***-G
9	1.6	1.65	XC929**16/1H***-G	T	3.1	3.15	XC929**31/3B***-G
A	1.7	1.75	XC929**17/1K***-G	U	3.2	3.25	XC929**32/3C***-G
B	1.8	1.85	XC929**18/1L***-G	V	3.3	3.35	XC929**33/3D***-G
C	1.9	1.95	XC929**19/1M***-G	X	3.4	3.45	XC929**34/3E***-G
D	2.0	2.05	XC929**20/2A***-G	Y	3.5	3.55	XC929**35/3F***-G
E	2.1	2.15	XC929**21/2B***-G	Z	3.6	-	XC929**36E**-G

④⑤ represents production lot number

01~09, 0A~0Z, 11~9Z, A1~A9, AA~AZ, B1~ZZ in order. (G, I, J, O, Q, W excluded)

* No character inversion used.

1. The product and product specifications contained herein are subject to change without notice to improve performance characteristics. Consult us, or our representatives before use, to confirm that the information in this datasheet is up to date.
2. The information in this datasheet is intended to illustrate the operation and characteristics of our products. We neither make warranties or representations with respect to the accuracy or completeness of the information contained in this datasheet nor grant any license to any intellectual property rights of ours or any third party concerning with the information in this datasheet.
3. Applicable export control laws and regulations should be complied and the procedures required by such laws and regulations should also be followed, when the product or any information contained in this datasheet is exported.
4. The product is neither intended nor warranted for use in equipment of systems which require extremely high levels of quality and/or reliability and/or a malfunction or failure which may cause loss of human life, bodily injury, serious property damage including but not limited to devices or equipment used in 1) nuclear facilities, 2) aerospace industry, 3) medical facilities, 4) automobile industry and other transportation industry and 5) safety devices and safety equipment to control combustions and explosions. Do not use the product for the above use unless agreed by us in writing in advance.
5. Although we make continuous efforts to improve the quality and reliability of our products; nevertheless Semiconductors are likely to fail with a certain probability. So in order to prevent personal injury and/or property damage resulting from such failure, customers are required to incorporate adequate safety measures in their designs, such as system fail safes, redundancy and fire prevention features.
6. Our products are not designed to be Radiation-resistant.
7. Please use the product listed in this datasheet within the specified ranges.
8. We assume no responsibility for damage or loss due to abnormal use.
9. All rights reserved. No part of this datasheet may be copied or reproduced unless agreed by Torex Semiconductor Ltd in writing in advance.

TOREX SEMICONDUCTOR LTD.