

OSRAM GW PUSRA1.HW

Datasheet

Published by **ams-OSRAM AG**

Tobelbader Strasse 30, 8141 Premstaetten, Austria

Phone +43 3136 500-0

ams-osram.com

© All rights reserved



OSCONIQ® P 3737 (2W)

GW PUSRA1.HW

High-power LED with our ams OSRAM's latest chip technology, delivering industry leading performance, superior robustness and long lifetime. With the introduction of a new color (Red 640 nm) the family offers five colors for ease of design and high flexibility for all your horticulture spectrum needs. The OSCONIQ® P 3737 family offers Hyper Red (660 nm), Red (640nm), Deep Blue (450 nm), Far Red (730 nm) and Horti White which can cater to both narrow spectrum and full spectrum solutions to meet all crop needs for both greenhouses and vertical farms.



Applications

- Agriculture & Horticulture
- Entertainment
- Indoor Lighting
- Outdoor & Industrial Lighting

Features

- Package: SMD epoxy package with silicone lens
- Typ. Radiation: 120° (Lambertian emitter)
- ESD: 8 kV acc. to ANSI/ESDA/JEDEC JS-001 (HBM, Class 3B)
- Radiant Flux (@ 700mA): typ. 1218 mW @ 25°C; typ. 1158 mW @ 85°C
- Radiant Efficiency (@ 700mA): typ. 59.6% @ 25°C; typ. 58.6% @ 85°C
- Photon Flux (@ 700mA): typ. 5.36 $\mu\text{mol/s}$ @ 25°C; typ. 5.08 $\mu\text{mol/s}$ @ 85°C
- Photon Flux Efficacy (@ 700mA): typ. 2.62 $\mu\text{mol/J}$ @ 25°C; typ. 2.57 $\mu\text{mol/J}$ @ 85°C

Ordering Information

| Type | Photon Flux ¹⁾ $I_F = 700 \text{ mA}$ Φ_P | Ordering Code |
|------------------------|---|---------------|
| GW PUSRA1.HW-SHSK-M1-1 | 4.60 ... 5.25 $\mu\text{mol/s}$ | Q65113A7876 |
| GW PUSRA1.HW-SHSK-M2-1 | 4.60 ... 5.25 $\mu\text{mol/s}$ | Q65113A7875 |
| GW PUSRA1.HW-SJSL-M3-1 | 4.80 ... 5.50 $\mu\text{mol/s}$ | Q65113A7880 |

Maximum Ratings

| Parameter | Symbol | Values |
|--|-----------|------------------------------------|
| Operating Temperature | T_{op} | min. -40 °C max. 125 °C |
| Storage Temperature | T_{stg} | min. -40 °C max. 125 °C |
| Junction Temperature | T_j | max. 135 °C |
| Forward current | I_F | min. 100 mA max. 1400 mA |
| Surge Current $t \leq 10 \mu s$; $D = 0.005$; $T_j = 85 \text{ °C}$ | I_{FS} | max. 2000 mA |
| Reverse voltage ²⁾ | V_R | Not designed for reverse operation |
| ESD withstand voltage acc. to ANSI/ESDA/JEDEC JS-001 (HBM, Class 3B) | V_{ESD} | 8 kV |

Characteristics

$I_F = 700 \text{ mA}$; $T_J = 85 \text{ °C}$

| Parameter | Symbol | | Values |
|--|--------------------------|----------------------|--|
| Viewing angle at 50% I_V | 2ϕ | typ. | 120 ° |
| Forward Voltage ³⁾ $I_F = 700 \text{ mA}$ | V_F | min. typ. max. | 2.75 V 2.82 V 2.95 V |
| Reverse current ²⁾ | I_R | | Not designed for reverse operation |
| Electrical thermal resistance junction/solderpoint with efficiency $\eta_e = 58.6 \%$ | $R_{thJS \text{ elec.}}$ | typ. | 1.7 K / W |

Brightness Groups

| Group | Photon Flux ¹⁾ | Photon Flux ¹⁾ | PF/W | Total Radiant Flux | |
|-------|--|--|------------------------|--------------------|------------------|
| | $I_F = 700 \text{ mA}$ min. Φ_P | $I_F = 700 \text{ mA}$ max. Φ_P | | typ. | min. Φ_E |
| SH | 4.60 $\mu\text{mol/s}$ | 4.80 $\mu\text{mol/s}$ | 2.40 $\mu\text{mol/J}$ | 1,043 mW | 1,088 mW |
| SJ | 4.80 $\mu\text{mol/s}$ | 5.00 $\mu\text{mol/s}$ | 2.50 $\mu\text{mol/J}$ | 1,088 mW | 1,134 mW |
| SK | 5.00 $\mu\text{mol/s}$ | 5.25 $\mu\text{mol/s}$ | 2.61 $\mu\text{mol/J}$ | 1,134 mW | 1,190 mW |
| SL | 5.25 $\mu\text{mol/s}$ | 5.50 $\mu\text{mol/s}$ | 2.74 $\mu\text{mol/J}$ | 1,190 mW | 1,248 mW |

Note: [*] Photon Flux includes wavelengths between 280 and 800 nm.

Note: [**] Radiant Flux values are for reference only.

Forward Voltage Groups

| Group | Forward Voltage ³⁾ | |
|-------|---|---|
| | $I_F = 700 \text{ mA}$ min. V_F | $I_F = 700 \text{ mA}$ max. V_F |
| 1W | 2.75 V | 2.80 V |
| 1Y | 2.80 V | 2.85 V |
| 1Z | 2.85 V | 2.90 V |
| 2A | 2.90 V | 2.95 V |

Chromaticity Coordinate Groups ⁴⁾

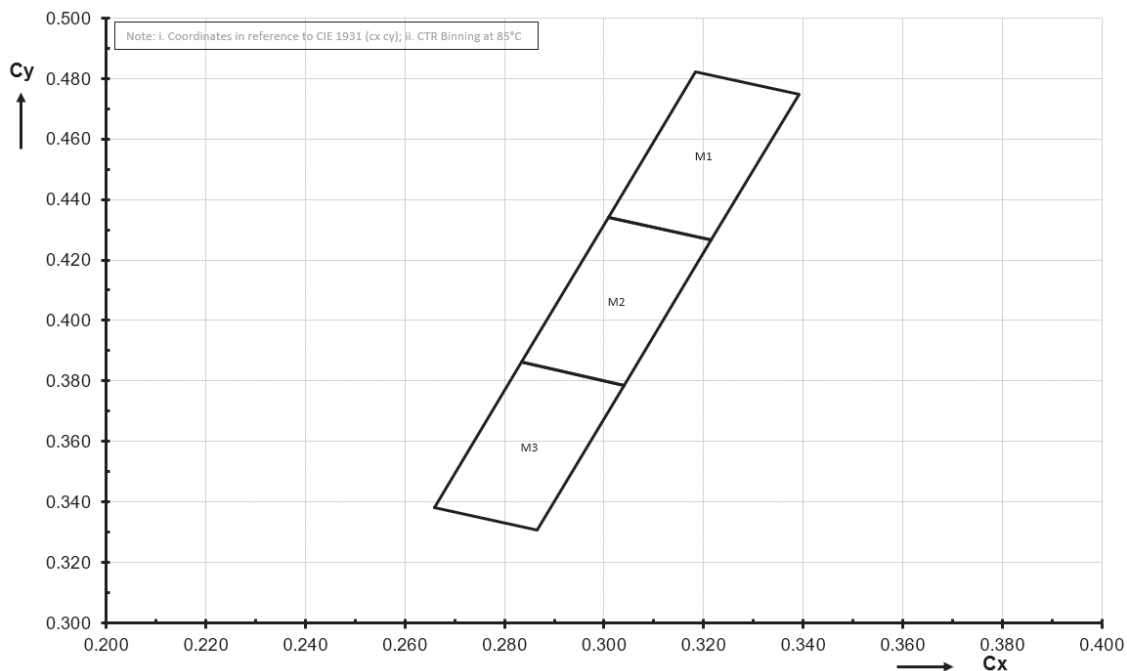

Chromaticity Coordinate Groups

| Group | Cx | Cy | Group | Cx | Cy | Group | Cx | Cy |
|-------|--------|--------|-------|--------|--------|-------|--------|--------|
| M1 | 0.3184 | 0.4822 | M2 | 0.3009 | 0.4342 | M3 | 0.2834 | 0.3861 |
| | 0.3391 | 0.4747 | | 0.3216 | 0.4266 | | 0.3041 | 0.3786 |
| | 0.3216 | 0.4266 | | 0.3041 | 0.3786 | | 0.2866 | 0.3306 |
| | 0.3009 | 0.4342 | | 0.2834 | 0.3861 | | 0.2659 | 0.3381 |

Group Name on Label

Example: SH-M1-1W

| Brightness | Color Chromaticity | Forward Voltage |
|------------|--------------------|-----------------|
| SH | M1 | 1W |

Relative Spectral Emission ⁵⁾

$I_{rel} = f(\lambda)$; $I_F = 700 \text{ mA}$; $T_J = 85 \text{ }^\circ\text{C}$

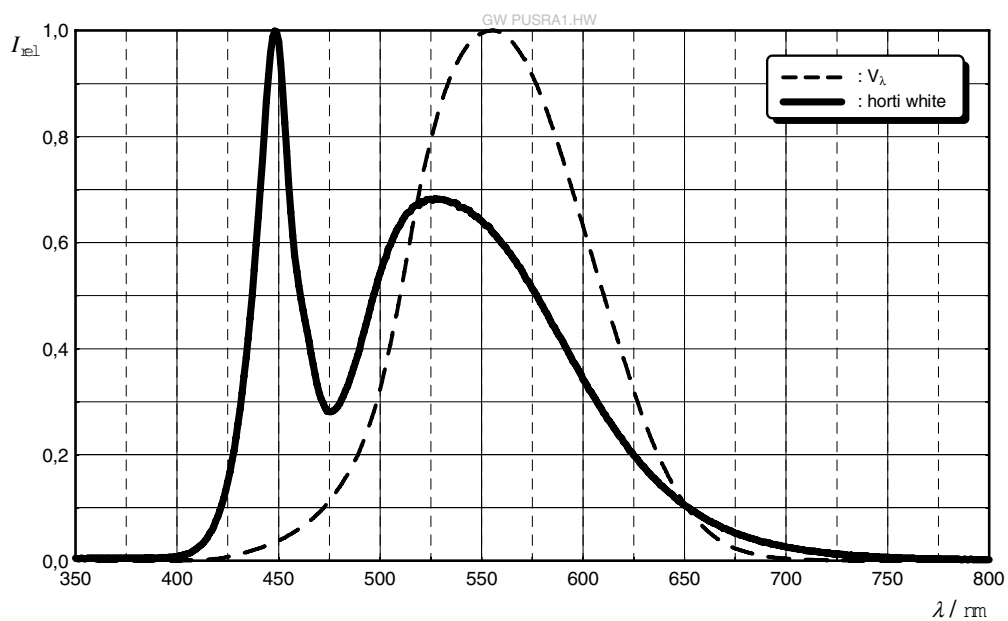

Radiation Characteristics ⁵⁾

$I_{rel} = f(\varphi)$; $T_J = 85 \text{ }^\circ\text{C}$

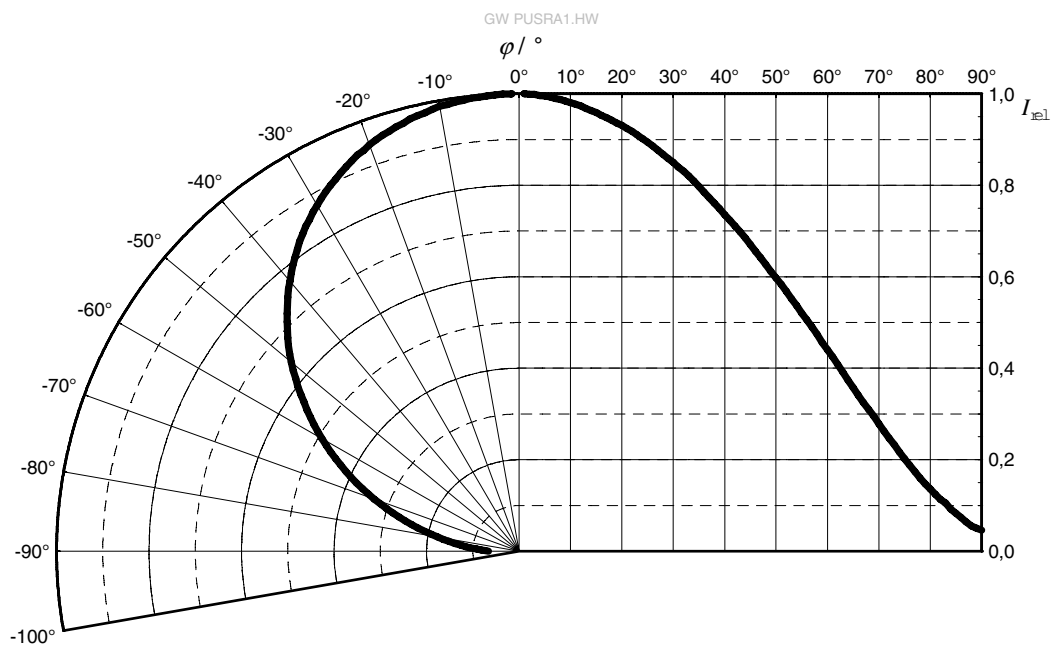

Forward current ⁵⁾

$I_F = f(V_F); T_J = 85\text{ °C}$

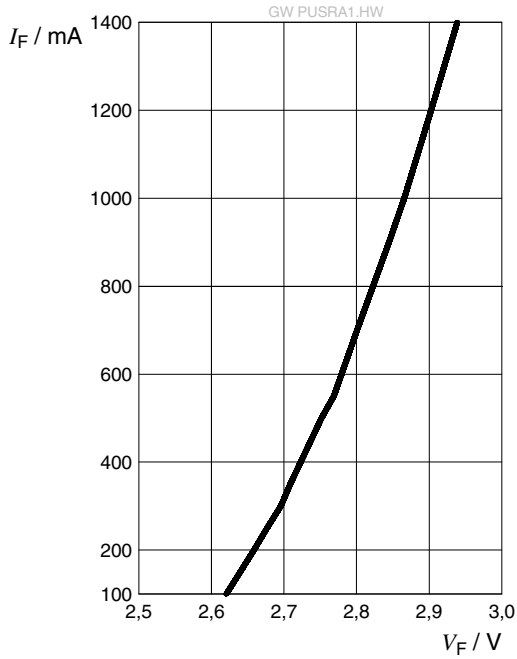

Relative Photon Flux ^{5), 6)}

$\Phi_p / \Phi_p(700\text{ mA}) = f(I_F); T_J = 85\text{ °C}$

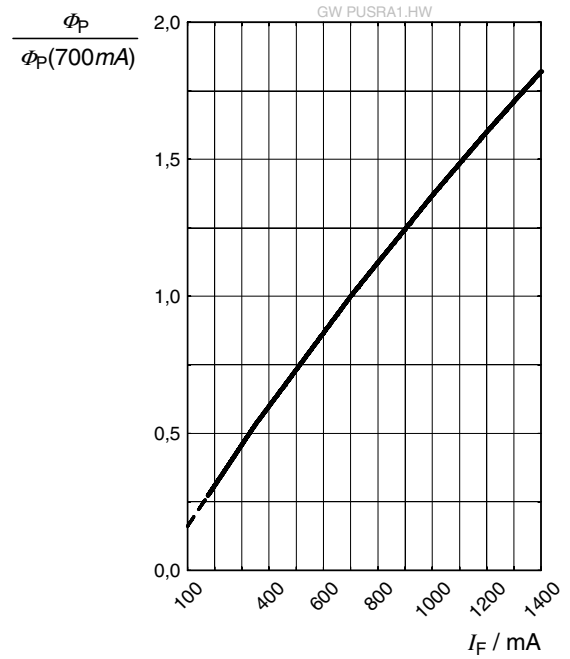

Chromaticity Coordinate Shift ⁵⁾

$\Delta Cx, \Delta Cy = f(I_F); T_J = 85\text{ °C}$

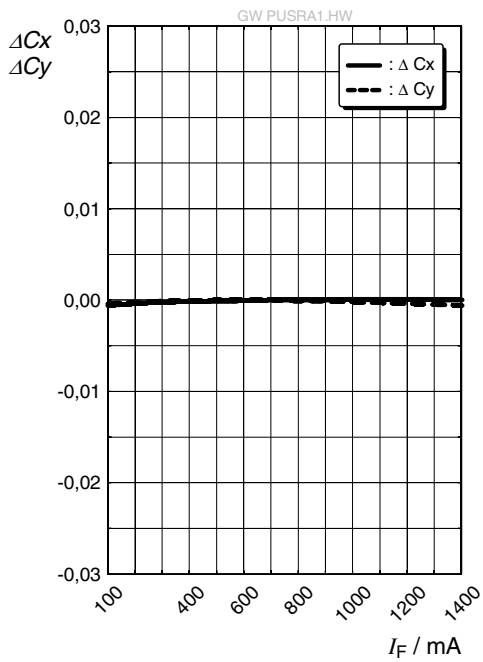

Forward Voltage ⁵⁾

$\Delta V_F = V_F - V_F(85^\circ\text{C}) = f(T_j); I_F = 700\text{ mA}$

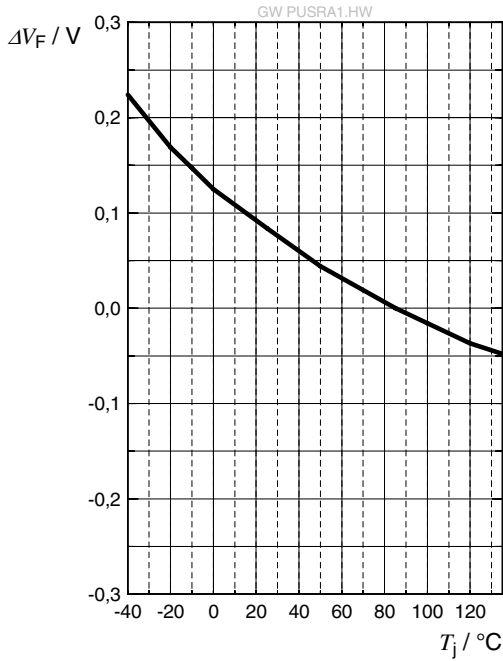

Relative Photon Flux ⁵⁾

$\Phi_p / \Phi_p(85^\circ\text{C}) = f(T_j); I_F = 700\text{ mA}$

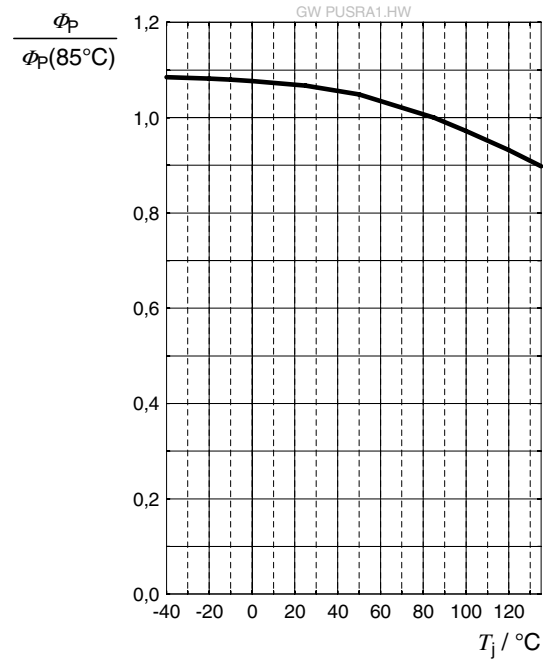

Chromaticity Coordinate Shift ⁵⁾

$\Delta Cx, \Delta Cy = f(T_j); I_F = 700\text{ mA}$

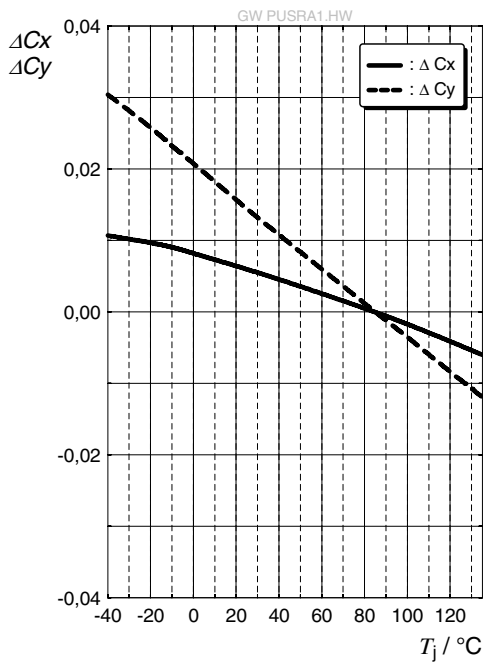

Max. Permissible Forward Current ⁷⁾

$$I_F = f(T)$$

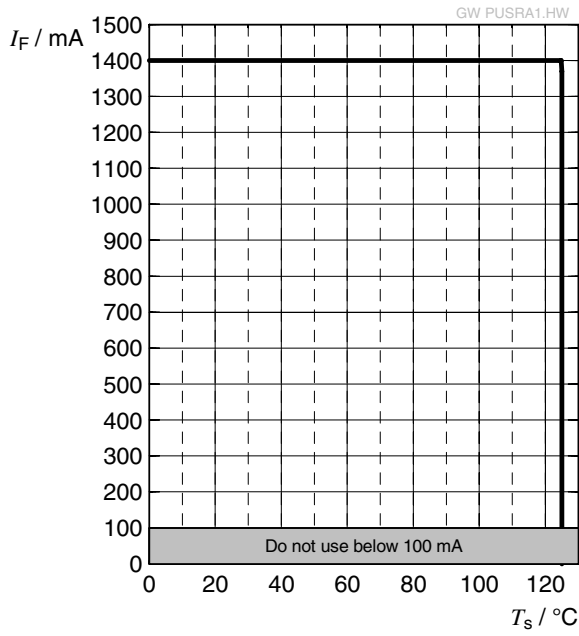

Dimensional Drawing ⁸⁾

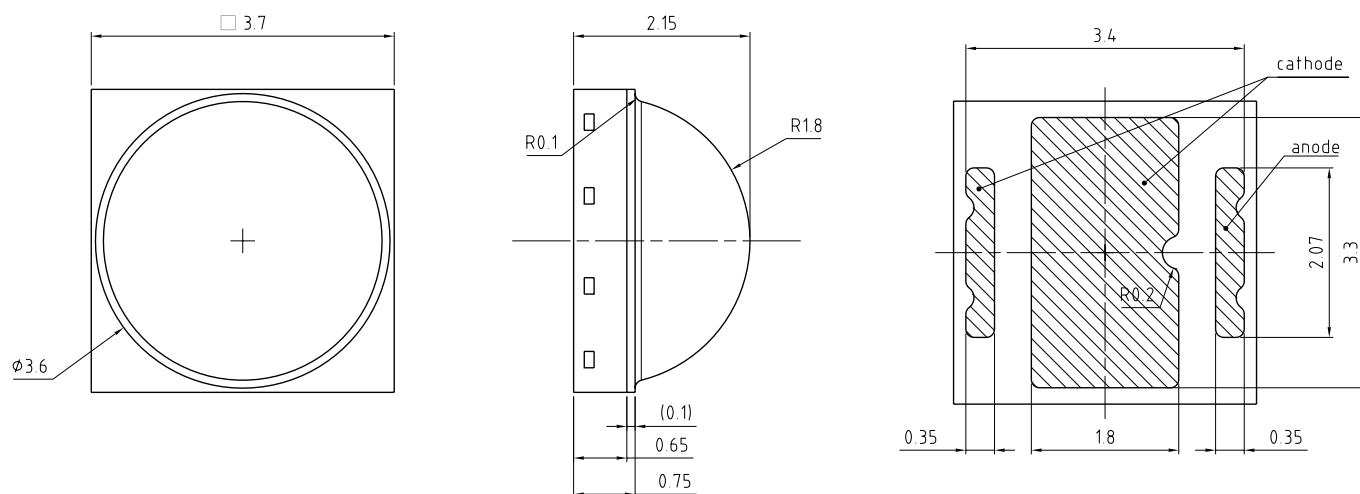

General tolerance ± 0.1

Lead finish Au 

C67062-A0172-A1-08

Further Information:

Approximate Weight: 43.0 mg

ESD advice: The device is protected by ESD device which is connected in parallel to the Chip.

Recommended Solder Pad ⁸⁾

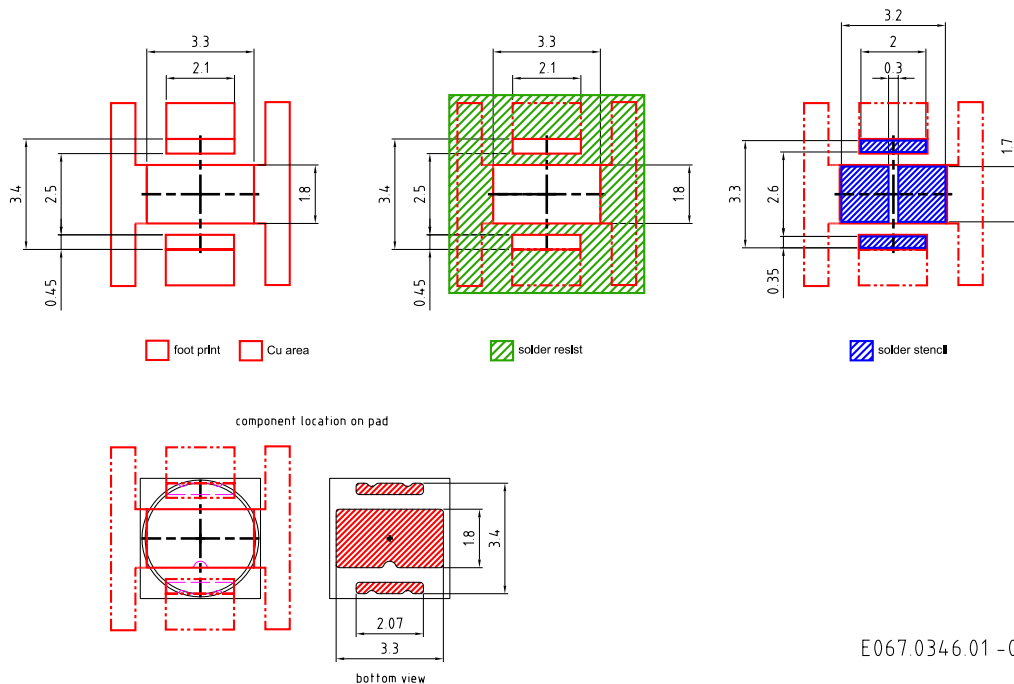

E067.0346.01 -05

For superior solder joint connectivity results we recommend soldering under standard nitrogen atmosphere. Package not suitable for ultra sonic cleaning.

Reflow Soldering Profile

Product complies to MSL Level 2 acc. to JEDEC J-STD-020E



| Profile Feature | Symbol | Pb-Free (SnAgCu) Assembly | | | Unit |
|--|--------|---------------------------|----------------|---------|------|
| | | Minimum | Recommendation | Maximum | |
| Ramp-up rate to preheat ^{*)} 25 °C to 150 °C | | | 2 | 3 | K/s |
| Time t_s T_{Smin} to T_{Smax} | t_s | 60 | 100 | 120 | s |
| Ramp-up rate to peak ^{*)} T_{Smax} to T_p | | | 2 | 3 | K/s |
| Liquidus temperature | T_L | | 217 | | °C |
| Time above liquidus temperature | t_L | | 80 | 100 | s |
| Peak temperature | T_p | | 245 | 260 | °C |
| Time within 5 °C of the specified peak temperature $T_p - 5$ K | t_p | 10 | 20 | 30 | s |
| Ramp-down rate* T_p to 100 °C | | | 3 | 6 | K/s |
| Time 25 °C to T_p | | | | 480 | s |

All temperatures refer to the center of the package, measured on the top of the component
 *) slope calculation DT/Dt : Dt max. 5 s; fulfillment for the whole T-range

Taping ⁸⁾

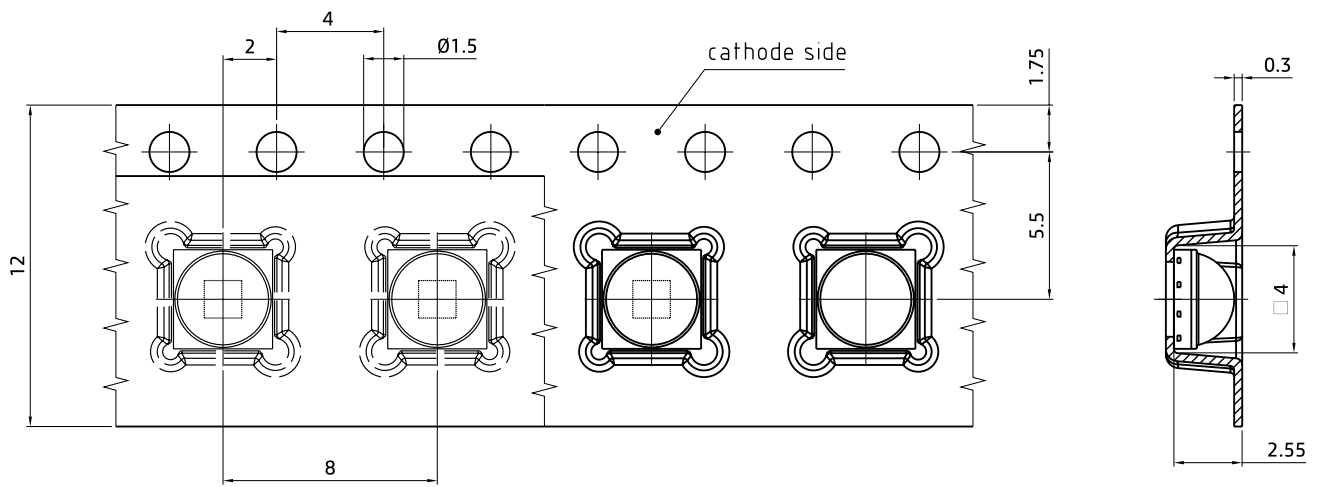

C67062-A0172-B11 -03

Tape and Reel ⁹⁾

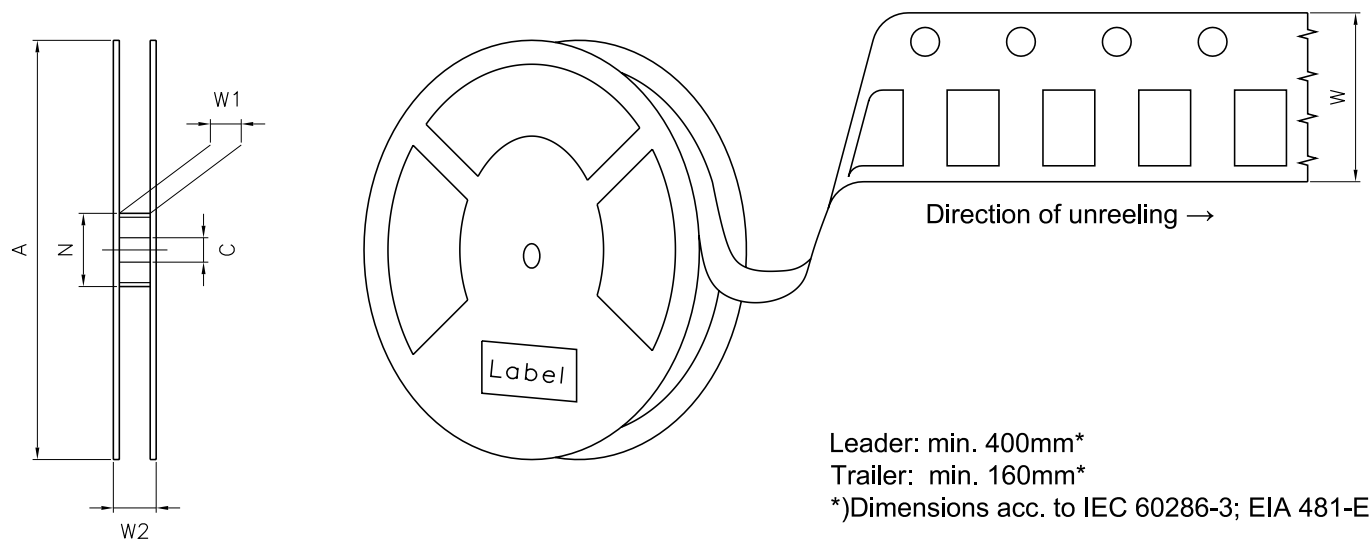

Reel Dimensions

| A | W | N _{min} | W ₁ | W _{2max} | Pieces per PU |
|--------|---------------------|------------------|----------------|-------------------|---------------|
| 330 mm | 12 + 0.3 / - 0.1 mm | 60 mm | 12.4 + 2 mm | 18.4 mm | 3000 |

Barcode-Product-Label (BPL)

OSRAM LX XXXX BIN1: XX-XX-X-XXX-X

RoHS Compliant

(6P) BATCH NO: 1234567890

(1T) LOT NO: 1234567890 (9D) D/C: 1234

(X) PROD NO: 123456789 (Q) QTY: 9999 (G) GROUP: XX-XX-X-X

ML Temp ST
X XXX °C X

Pack: RXX
DEMY XXX
X_X123_1234.1234 X

OHA04563

Dry Packing Process and Materials



OHA00539

Moisture-sensitive product is packed in a dry bag containing desiccant and a humidity card according JEDEC-STD-033.

Notes

The evaluation of eye safety occurs according to the standard IEC 62471:2006 (photo biological safety of lamps and lamp systems). Within the risk grouping system of this IEC standard, the device specified in this data sheet fall into the class **moderate risk (exposure time 0.25 s)**. Under real circumstances (for exposure time, conditions of the eye pupils, observation distance), it is assumed that no endangerment to the eye exists from these devices. As a matter of principle, however, it should be mentioned that intense light sources have a high secondary exposure potential due to their blinding effect. When looking at bright light sources (e.g. headlights), temporary reduction in visual acuity and afterimages can occur, leading to irritation, annoyance, visual impairment, and even accidents, depending on the situation.

Subcomponents of this device contain, in addition to other substances, metal filled materials including silver. Metal filled materials can be affected by environments that contain traces of aggressive substances. Therefore, we recommend that customers minimize device exposure to aggressive substances during storage, production, and use. Devices that showed visible discoloration when tested using the described tests above did show no performance deviations within failure limits during the stated test duration. Respective failure limits are described in the IEC60810.

This device is designed for specific/recommended applications only. Please consult OSRAM Opto Semiconductors Sales Staff in advance for detailed information on other non-recommended applications (e.g. automotive).

Change management for this component is aligned with the requirements of the lighting market.

For further application related information please visit <https://ams-osram.com/support/application-notes>

Disclaimer

Attention please!

The information describes the type of component and shall not be considered as assured characteristics. Terms of delivery and rights to change design reserved. Due to technical requirements components may contain dangerous substances.

For information on the types in question please contact our Sales Organization.

If printed or downloaded, please find the latest version on our website.

Packing

Please use the recycling operators known to you. We can also help you – get in touch with your nearest sales office. By agreement we will take packing material back, if it is sorted. You must bear the costs of transport. For packing material that is returned to us unsorted or which we are not obliged to accept, we shall have to invoice you for any costs incurred.

Product and functional safety devices/applications or medical devices/applications

Our components are not developed, constructed or tested for the application as safety relevant component or for the application in medical devices.

Our products are not qualified at module and system level for such application.

In case buyer – or customer supplied by buyer – considers using our components in product safety devices/ applications or medical devices/applications, buyer and/or customer has to inform our local sales partner immediately and we and buyer and /or customer will analyze and coordinate the customer-specific request between us and buyer and/or customer.

Glossary

- 1) **Brightness:** Brightness values are measured during a current pulse of typically 10 ms, with a tolerance of +/- 7%.
- 2) **Reverse Operation:** Not designed for reverse operation. Continuous reverse operation can cause migration and damage of the device.
- 3) **Forward Voltage:** The Forward voltage is measured during a current pulse duration of typically 1 ms with a tolerance of $\pm 0.05V$.
- 4) **Chromaticity coordinate groups:** Chromaticity coordinate groups are measured during a current pulse duration of typically 10ms with a tolerance of ± 0.005 .
- 5) **Typical Values:** Due to the special conditions of the manufacturing processes of semiconductor devices, the typical data or calculated correlations of technical parameters can only reflect statistical figures. These do not necessarily correspond to the actual parameters of each single product, which could differ from the typical data and calculated correlations or the typical characteristic line. If requested, e.g. because of technical improvements, these typ. data will be changed without any further notice.
- 6) **Characteristic curve:** In the range where the line of the graph is broken, you must expect higher differences between single devices within one packing unit.
- 7) **Thermal Resistance:** $R_{th\ max}$ is based on statistic values (6σ) used for Derating.
- 8) **Tolerance of Measure:** Unless otherwise noted in drawing, tolerances are specified with ± 0.1 and dimensions are specified in mm.
- 9) **Tape and Reel:** All dimensions and tolerances are specified acc. IEC 60286-3 and specified in mm.

Revision History

| Version | Date | Change |
|---------|------------|-----------------|
| 1.0 | 2024-04-08 | Initial Version |



EU RoHS and China RoHS compliant product

此产品符合欧盟 RoHS 指令的要求；
按照中国的相关法规和标准，
不含有毒有害物质或元素。

Published by ams-OSRAM AG

Tobelbader Strasse 30, 8141 Premstaetten, Austria

Phone +43 3136 500-0

ams-osram.com

© All rights reserved

am 

OSRAM