

# TAR5SB15 to TAR5SB50

## Point Regulators (Low-Dropout Regulator)

The TAR5SBxx Series is comprised of general-purpose bipolar single-power-supply devices incorporating a control pin which can be used to turn them ON/OFF.

Overtemperature and overcurrent protection circuits are built-in to the devices' output circuit.

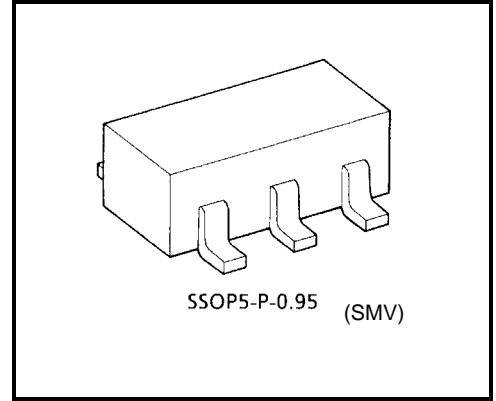

Weight: 0.014 g (typ.)

### 1. Features

- Low stand-by current
- Overtemperature/overcurrent protection
- Operation voltage range is wide.
- Maximum output current is high.
- Difference between input voltage and output voltage is low.
- Small package: SMV (SOT-25) (SC-74A)
- Ceramic capacitors can be used.

### 2. Pin Assignments (top view)

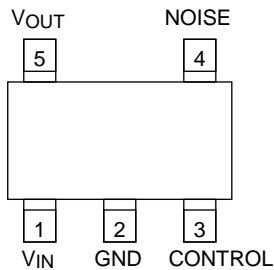

Overtemperature protection and overcurrent protection functions are not necessary guarantee of operating ratings below the absolute maximum ratings.

Do not use devices under conditions in which their absolute maximum ratings will be exceeded.

Start of commercial production  
2002-09

### 3. List of Products Number and Marking

Products No.	Marking	Products No.	Marking
TAR5SB15	1B5	TAR5SB33	3B3
TAR5SB16	1B6	TAR5SB34	3B4
TAR5SB17	1B7	TAR5SB35	3B5
TAR5SB18	1B8	TAR5SB36	3B6
TAR5SB19	1B9	TAR5SB37	3B7
TAR5SB20	2B0	TAR5SB38	3B8
TAR5SB21	2B1	TAR5SB39	3B9
TAR5SB22	2B2	TAR5SB40	4B0
TAR5SB23	2B3	TAR5SB41	4B1
TAR5SB24	2B4	TAR5SB42	4B2
TAR5SB25	2B5	TAR5SB43	4B3
TAR5SB26	2B6	TAR5SB44	4B4
TAR5SB27	2B7	TAR5SB45	4B5
TAR5SB28	2B8	TAR5SB46	4B6
TAR5SB29	2B9	TAR5SB47	4B7
TAR5SB30	3B0	TAR5SB48	4B8
TAR5SB31	3B1	TAR5SB49	4B9
TAR5SB32	3B2	TAR5SB50	5B0

### Marking on the Product

Example: TAR5SB30 (3.0 V output)

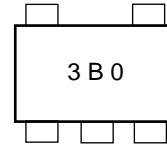

### 4. Absolute Maximum Ratings (Note) (Ta = 25°C)

Characteristics	Symbol	Rating	Unit
Supply voltage	V <sub>IN</sub>	15	V
Output current	I <sub>OUT</sub>	200	mA
Power dissipation	P <sub>D</sub>	200 (Note 1)	mW
		380 (Note 2)	
Operation temperature range	T <sub>opr</sub>	-40 to 85	°C
Storage temperature range	T <sub>stg</sub>	-55 to 150	°C

Note: Using continuously under heavy loads (e.g. the application of high temperature/current/voltage and the significant change in temperature, etc.) may cause this product to decrease in the reliability significantly even if the operating conditions (i.e. operating temperature/current/voltage, etc.) are within the absolute maximum ratings and the operating ranges.

Please design the appropriate reliability upon reviewing the Toshiba Semiconductor Reliability Handbook (“Handling Precautions”/“Derating Concept and Methods”) and individual reliability data (i.e. reliability test report and estimated failure rate, etc).

Note 1: Unit Rating

Note 2: Mounted on a glass epoxy circuit board of 30 × 30 mm. Pad dimension of 50 mm<sup>2</sup>

## TAR5SB15 to TAR5SB22

### 5. Electrical Characteristic (Unless otherwise specified, $V_{IN} = V_{OUT} + 1\text{ V}$ , $I_{OUT} = 50\text{ mA}$ , $C_{IN} = 1\text{ }\mu\text{F}$ , $C_{OUT} = 10\text{ }\mu\text{F}$ , $C_{NOISE} = 0.01\text{ }\mu\text{F}$ , $T_j = 25^\circ\text{C}$ )

Characteristics	Symbol	Test Condition	Min	Typ.	Max	Unit
Output voltage	$V_{OUT}$	Please refer to the Output Voltage Accuracy table.				
Line regulation	Reg·line	$V_{OUT} + 1\text{ V} \leq V_{IN} \leq 15\text{ V}$ , $I_{OUT} = 1\text{ mA}$	—	3	15	mV
Load regulation	Reg·load	$1\text{ mA} \leq I_{OUT} \leq 150\text{ mA}$	—	25	75	mV
Quiescent current	$I_{B1}$	$I_{OUT} = 0\text{ mA}$	—	170	—	$\mu\text{A}$
	$I_{B2}$	$I_{OUT} = 50\text{ mA}$	—	550	850	
Stand-by current	$I_B$ (OFF)	$V_{CT} = 0\text{ V}$	—	—	0.1	$\mu\text{A}$
Output noise voltage	$V_{NO}$	$V_{IN} = V_{OUT} + 1\text{ V}$ , $I_{OUT} = 10\text{ mA}$ , $10\text{ Hz} \leq f \leq 100\text{ kHz}$ , $C_{NOISE} = 0.01\text{ }\mu\text{F}$ , $T_a = 25^\circ\text{C}$	—	30	—	$\mu\text{V}_{rms}$
Temperature coefficient	$T_{CVO}$	$-40^\circ\text{C} \leq T_{opr} \leq 85^\circ\text{C}$	—	100	—	ppm/ $^\circ\text{C}$
Input voltage	$V_{IN}$	—	2.4	—	15	V
Ripple rejection	R.R.	$V_{IN} = V_{OUT} + 1\text{ V}$ , $I_{OUT} = 10\text{ mA}$ , $C_{NOISE} = 0.01\text{ }\mu\text{F}$ , $f = 1\text{ kHz}$ , $V_{Ripple} = 500\text{ mV}_{p-p}$ , $T_a = 25^\circ\text{C}$	—	70	—	dB
Control voltage (ON)	$V_{CT}$ (ON)	—	1.5	—	$V_{IN}$	V
Control voltage (OFF)	$V_{CT}$ (OFF)	—	—	—	0.4	V
Control current (ON)	$I_{CT}$ (ON)	$V_{CT} = 1.5\text{ V}$	—	3	10	$\mu\text{A}$
Control current (OFF)	$I_{CT}$ (OFF)	$V_{CT} = 0\text{ V}$	—	0	0.1	$\mu\text{A}$

## TAR5SB23 to TAR5SB50

### Electrical Characteristic (Unless otherwise specified, $V_{IN} = V_{OUT} + 1\text{ V}$ , $I_{OUT} = 50\text{ mA}$ , $C_{IN} = 1\text{ }\mu\text{F}$ , $C_{OUT} = 10\text{ }\mu\text{F}$ , $C_{NOISE} = 0.01\text{ }\mu\text{F}$ , $T_j = 25^\circ\text{C}$ )

Characteristics	Symbol	Test Condition	Min	Typ.	Max	Unit
Output voltage	$V_{OUT}$	Please refer to the Output Voltage Accuracy table.				
Line regulation	Reg·line	$V_{OUT} + 1\text{ V} \leq V_{IN} \leq 15\text{ V}$ , $I_{OUT} = 1\text{ mA}$	—	3	15	mV
Load regulation	Reg·load	$1\text{ mA} \leq I_{OUT} \leq 150\text{ mA}$	—	25	75	mV
Quiescent current	$I_{B1}$	$I_{OUT} = 0\text{ mA}$	—	170	—	$\mu\text{A}$
	$I_{B2}$	$I_{OUT} = 50\text{ mA}$	—	550	850	
Stand-by current	$I_B$ (OFF)	$V_{CT} = 0\text{ V}$	—	—	0.1	$\mu\text{A}$
Output noise voltage	$V_{NO}$	$V_{IN} = V_{OUT} + 1\text{ V}$ , $I_{OUT} = 10\text{ mA}$ , $10\text{ Hz} \leq f \leq 100\text{ kHz}$ , $C_{NOISE} = 0.01\text{ }\mu\text{F}$ , $T_a = 25^\circ\text{C}$	—	30	—	$\mu\text{V}_{rms}$
Dropout voltage	$V_{IN} - V_{OUT}$	$I_{OUT} = 50\text{ mA}$	—	130	200	mV
Temperature coefficient	$T_{CVO}$	$-40^\circ\text{C} \leq T_{opr} \leq 85^\circ\text{C}$	—	100	—	ppm/ $^\circ\text{C}$
Input voltage	$V_{IN}$	—	$V_{OUT} + 0.2\text{ V}$	—	15	V
Ripple rejection	R.R.	$V_{IN} = V_{OUT} + 1\text{ V}$ , $I_{OUT} = 10\text{ mA}$ , $C_{NOISE} = 0.01\text{ }\mu\text{F}$ , $f = 1\text{ kHz}$ , $V_{Ripple} = 500\text{ mV}_{p-p}$ , $T_a = 25^\circ\text{C}$	—	70	—	dB
Control voltage (ON)	$V_{CT}$ (ON)	—	1.5	—	$V_{IN}$	V
Control voltage (OFF)	$V_{CT}$ (OFF)	—	—	—	0.4	V
Control current (ON)	$I_{CT}$ (ON)	$V_{CT} = 1.5\text{ V}$	—	3	10	$\mu\text{A}$
Control current (OFF)	$I_{CT}$ (OFF)	$V_{CT} = 0\text{ V}$	—	0	0.1	$\mu\text{A}$

## 6. Output Voltage Accuracy

( $V_{IN} = V_{OUT} + 1\text{ V}$ ,  $I_{OUT} = 50\text{ mA}$ ,  $C_{IN} = 1\text{ }\mu\text{F}$ ,  $C_{OUT} = 10\text{ }\mu\text{F}$ ,  $C_{NOISE} = 0.01\text{ }\mu\text{F}$ ,  $T_j = 25^\circ\text{C}$ )

Product No.	Symbol	Min	Typ.	Max	Unit
TAR5SB15	V <sub>OUT</sub>	1.44	1.5	1.56	V
TAR5SB16		1.54	1.6	1.66	
TAR5SB17		1.64	1.7	1.76	
TAR5SB18		1.74	1.8	1.86	
TAR5SB19		1.84	1.9	1.96	
TAR5SB20		1.94	2.0	2.06	
TAR5SB21		2.04	2.1	2.16	
TAR5SB22		2.14	2.2	2.26	
TAR5SB23		2.24	2.3	2.36	
TAR5SB24		2.34	2.4	2.46	
TAR5SB25		2.43	2.5	2.57	
TAR5SB26		2.53	2.6	2.67	
TAR5SB27		2.63	2.7	2.77	
TAR5SB28		2.73	2.8	2.87	
TAR5SB29		2.83	2.9	2.97	
TAR5SB30		2.92	3.0	3.08	
TAR5SB31		3.02	3.1	3.18	
TAR5SB32		3.12	3.2	3.28	
TAR5SB33		3.21	3.3	3.39	
TAR5SB34		3.31	3.4	3.49	
TAR5SB35		3.41	3.5	3.59	
TAR5SB36		3.51	3.6	3.69	
TAR5SB37		3.6	3.7	3.8	
TAR5SB38		3.7	3.8	3.9	
TAR5SB39		3.8	3.9	4.0	
TAR5SB40		3.9	4.0	4.1	
TAR5SB41		3.99	4.1	4.21	
TAR5SB42		4.09	4.2	4.31	
TAR5SB43		4.19	4.3	4.41	
TAR5SB44		4.29	4.4	4.51	
TAR5SB45	4.38	4.5	4.62		
TAR5SB46	4.48	4.6	4.72		
TAR5SB47	4.58	4.7	4.82		
TAR5SB48	4.68	4.8	4.92		
TAR5SB49	4.77	4.9	5.03		
TAR5SB50	4.87	5.0	5.13		

## 7. Application Note

### 1. Recommended Application Circuit

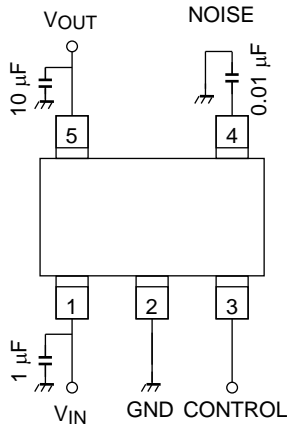

Control Level	Operation
HIGH	ON
LOW	OFF

The figure above shows the recommended configuration for using a point regulator. Insert a capacitor for stable input/output operation.

If the control function is not to be used, Toshiba recommend that the control pin (pin 1) be connected to the  $V_{CC}$  pin.

### 2. Power Dissipation

The power dissipation for board-mounted TAR5SBxx Series devices (rated at 380 mW) is measured using a board whose size and pattern are as shown below. When incorporating a device belonging to this series into your design, derate the power dissipation as far as possible by reducing the levels of parameters such as input voltage, output current and ambient temperature. Toshiba recommend that these devices should typically be derated to 70% to 80% of their absolute maximum power dissipation value.

### Thermal Resistance Evaluation Board

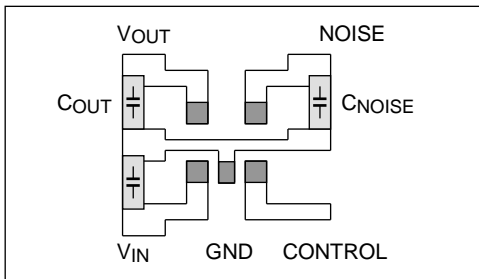

Circuit board material: glass epoxy,  
 Circuit board dimension: 30 mm × 30 mm,  
 Copper foil pad area: 50 mm<sup>2</sup> (t = 0.8 mm)

### 3. Ripple Rejection

The devices of the TAR5SBxx Series feature a circuit with an excellent ripple rejection characteristic. Because the circuit also features an excellent output fluctuation characteristic for sudden supply voltage drops, the circuit is ideal for use in the RF blocks incorporated in all mobile telephones.

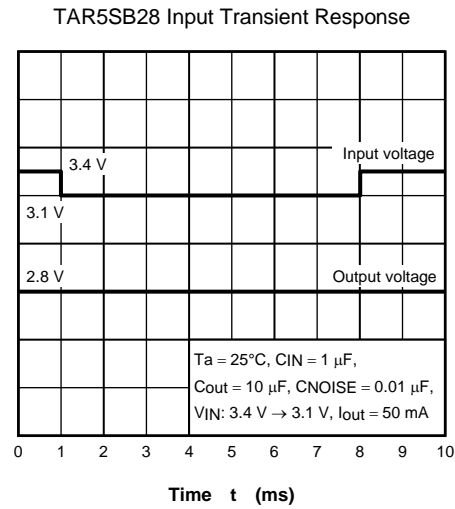
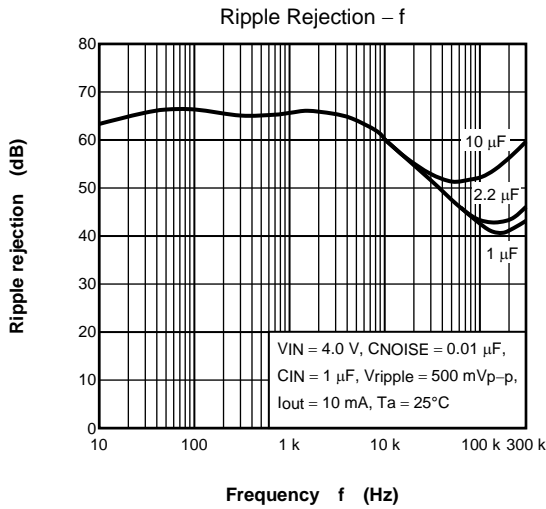

### 4. NOISE Pin

TAR5SBxx Series devices incorporate a NOISE pin to reduce output noise voltage. Inserting a capacitor between the NOISE pin and GND reduces output noise. To ensure stable operation, insert a capacitor of 0.0047  $\mu\text{F}$  or more between the NOISE pin and GND.

The output voltage rise time varies according to the capacitance of the capacitor connected to the NOISE pin.

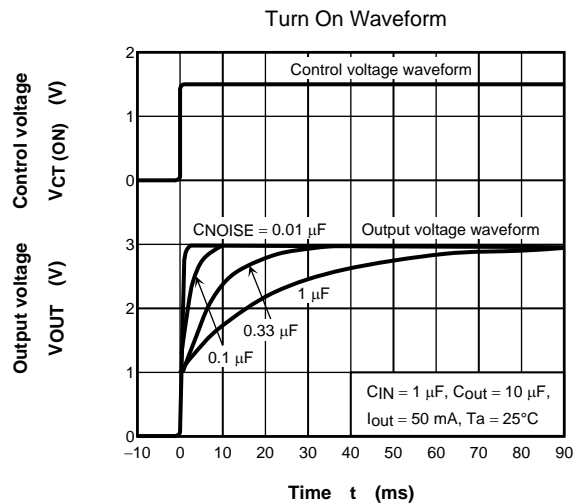
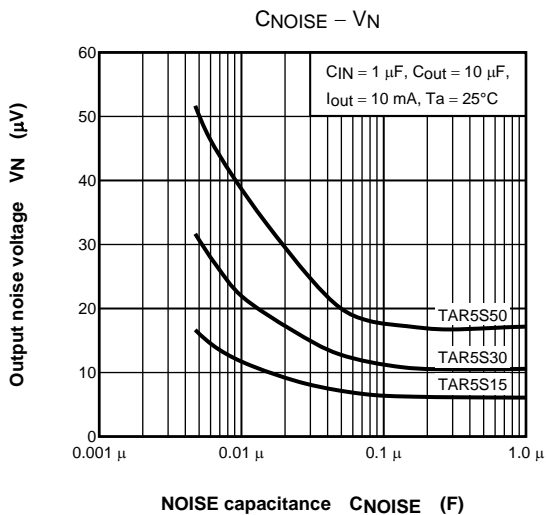

## 5. Example of Characteristics when Ceramic Capacitor is Used

Shown below is the stable operation area, where the output voltage does not oscillate, evaluated using a Toshiba evaluation circuit. The equivalent series resistance (ESR) of the output capacitor and output current determines this area. TAR5SBxx Series devices operate stably even when a ceramic capacitor is used as the output capacitor.

If a ceramic capacitor is used as the output capacitor and the ripple frequency is 30 kHz or more, the ripple rejection differs from that when a tantalum capacitor is used. This is shown below.

Toshiba recommend that users check that devices operate stably under the intended conditions of use.

### Examples of safe operating area characteristics

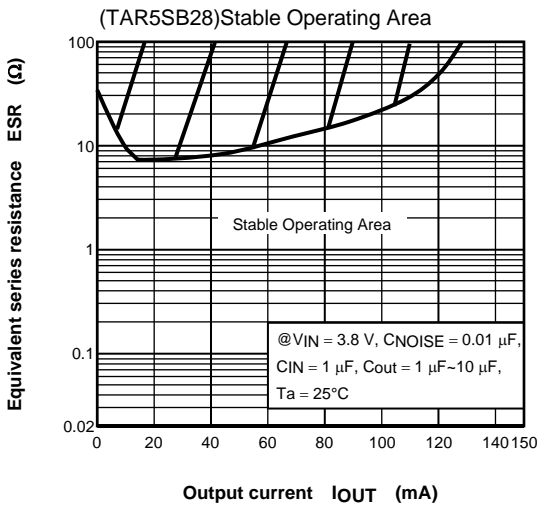
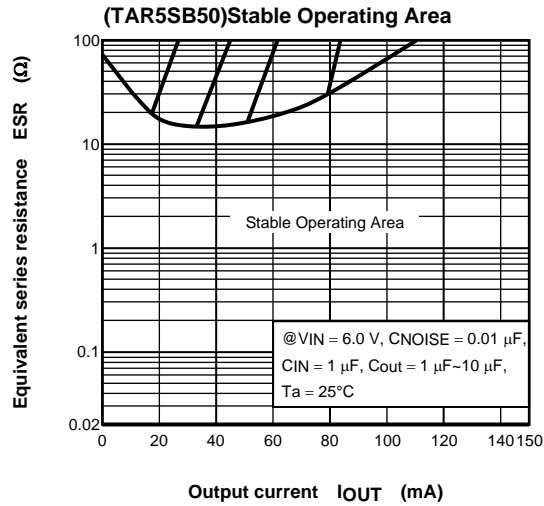
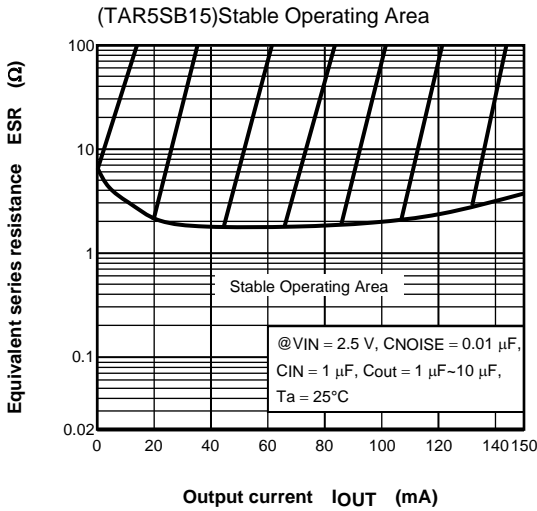

### Evaluation Circuit for Stable Operating Area

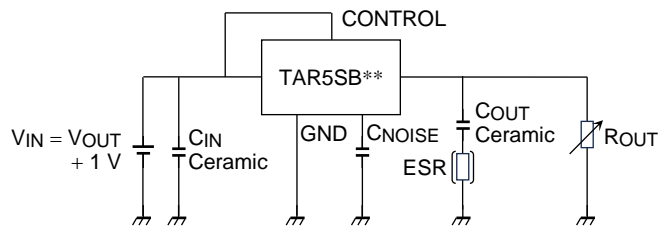

Capacitors used for evaluation  
 Made by Murata CIN: GRM40B105K  
 COUT: GRM40B105K/GRM40B106K

### Ripple Rejection Characteristic (f = 10 kHz to 300 kHz)

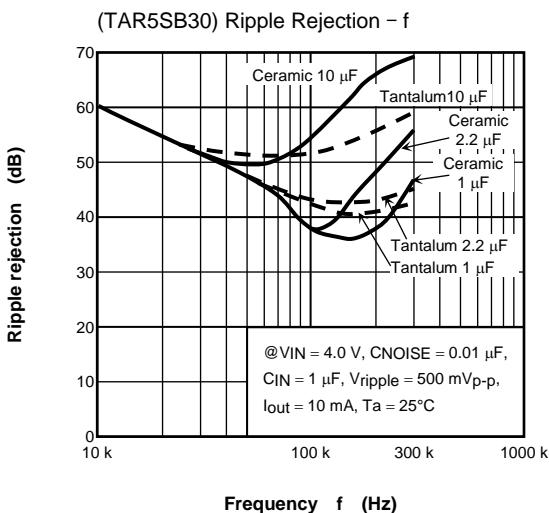

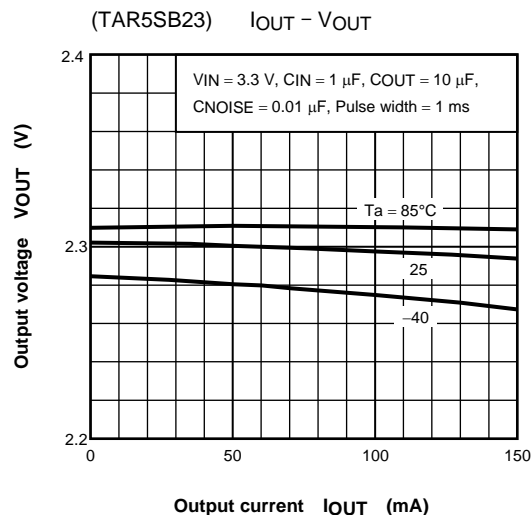
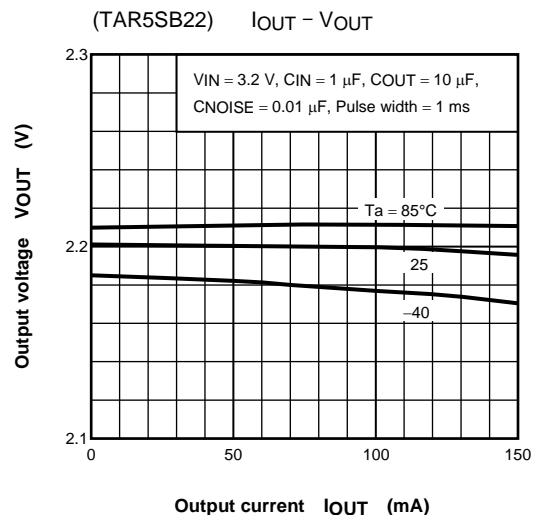
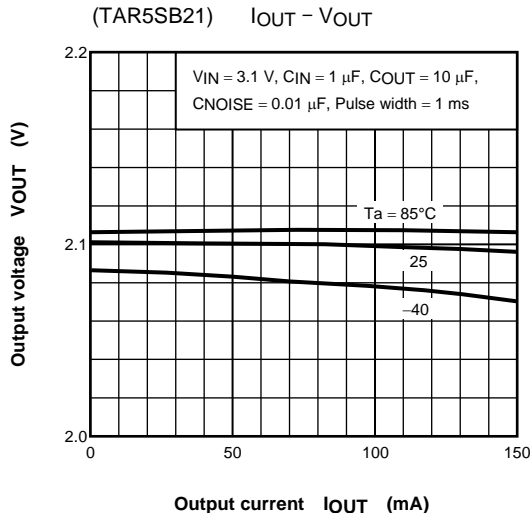
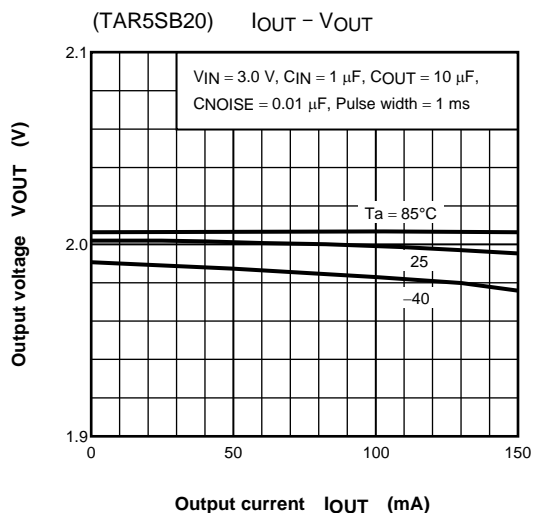
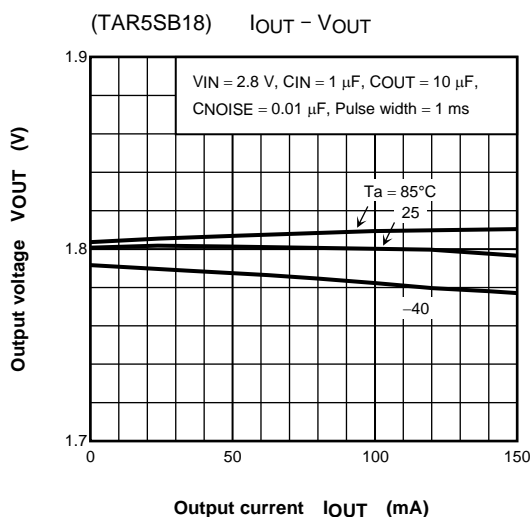
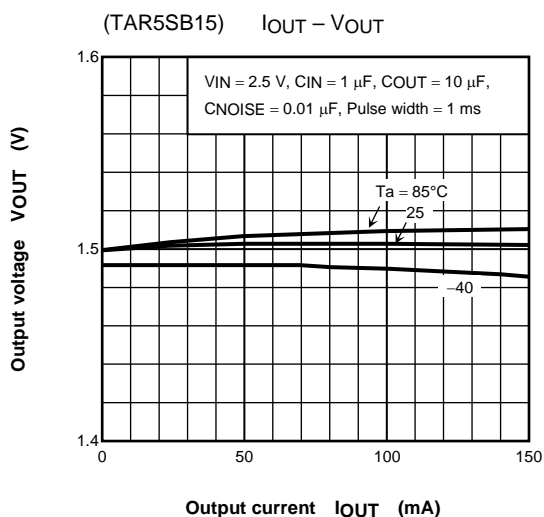



(TAR5SB25) I<sub>OUT</sub> - V<sub>OUT</sub>

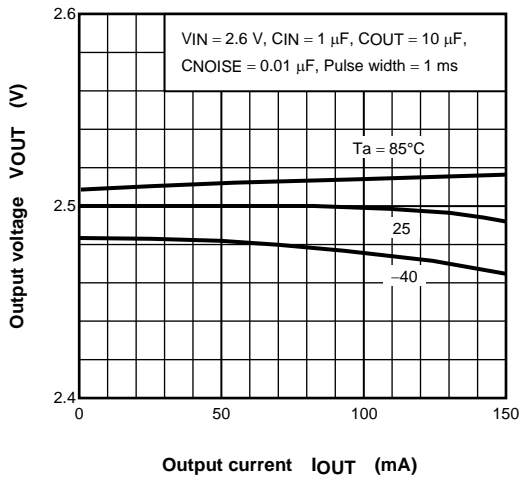

(TAR5SB27) I<sub>OUT</sub> - V<sub>OUT</sub>

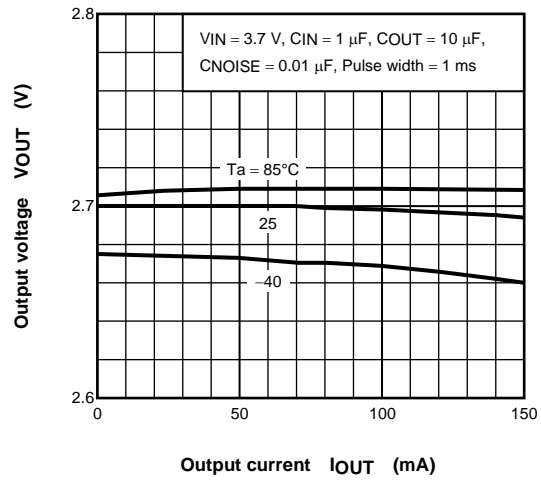

(TAR5SB28) I<sub>OUT</sub> - V<sub>OUT</sub>

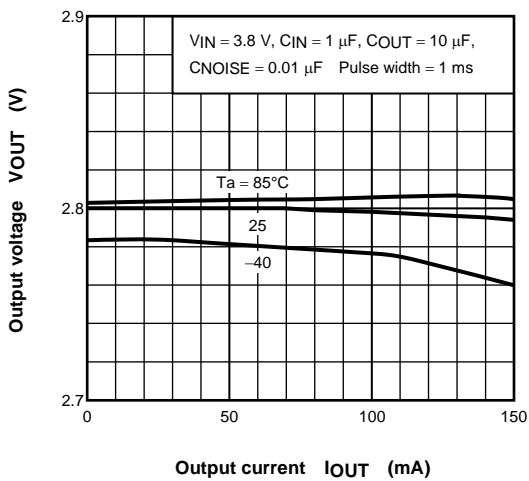

(TAR5SB29) I<sub>OUT</sub> - V<sub>OUT</sub>

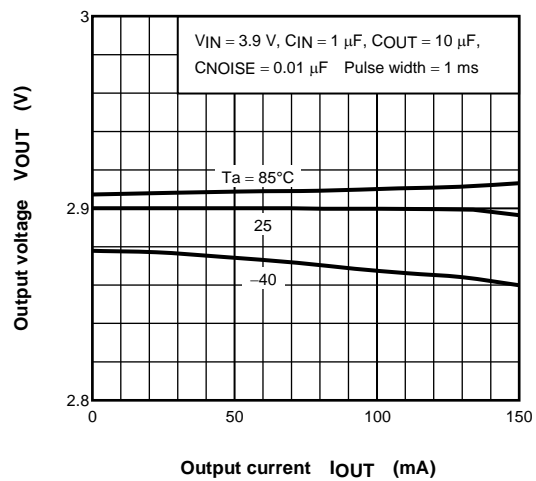

(TAR5SB30) I<sub>OUT</sub> - V<sub>OUT</sub>

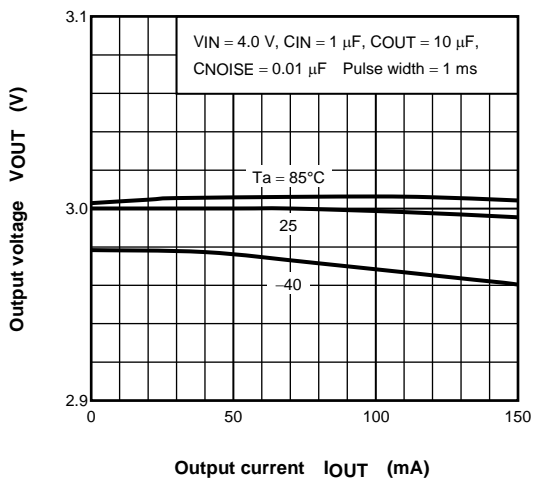

(TAR5SB31) I<sub>OUT</sub> - V<sub>OUT</sub>

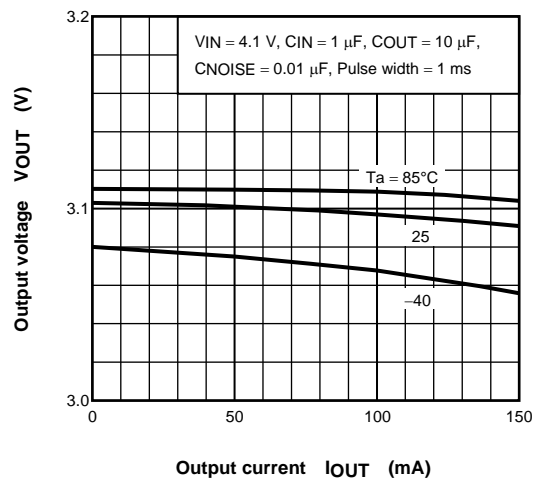

(TAR5SB32) I<sub>OUT</sub> - V<sub>OUT</sub>

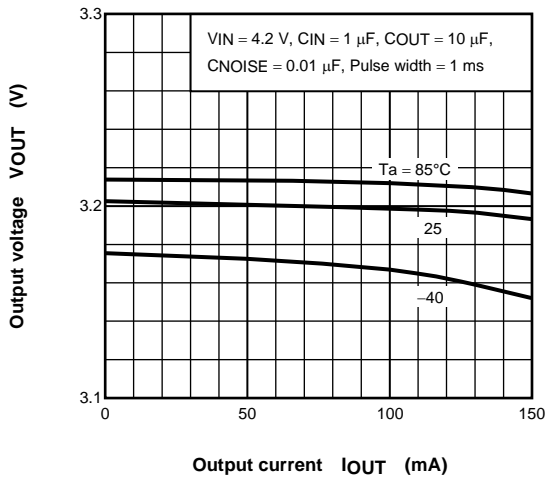

(TAR5SB33) I<sub>OUT</sub> - V<sub>OUT</sub>

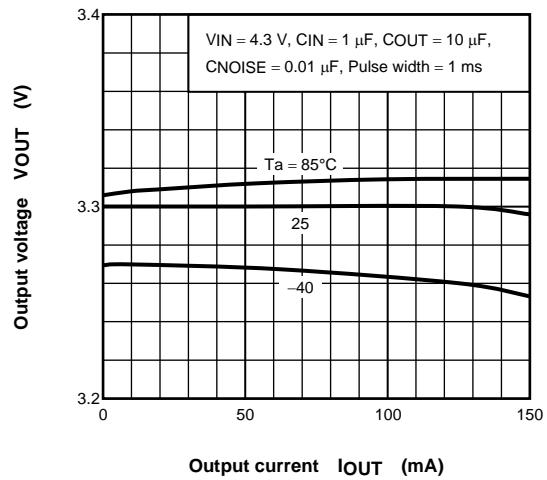

(TAR5SB35) I<sub>OUT</sub> - V<sub>OUT</sub>

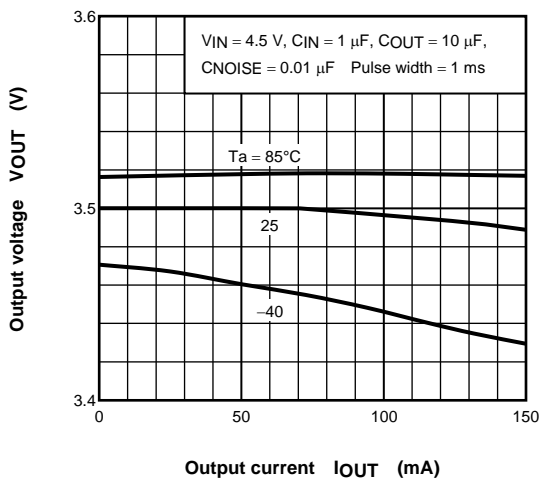

(TAR5SB45) I<sub>OUT</sub> - V<sub>OUT</sub>

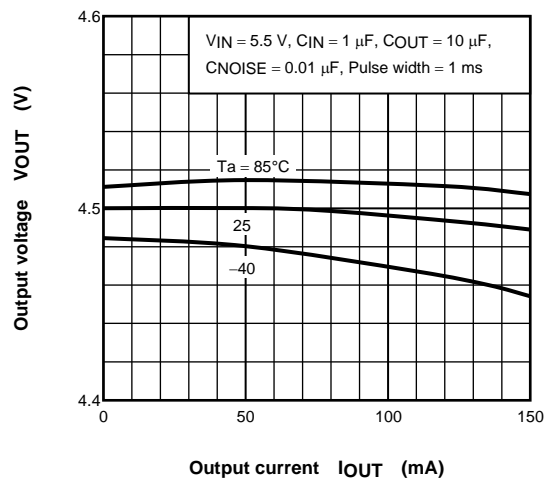

(TAR5SB48) I<sub>OUT</sub> - V<sub>OUT</sub>

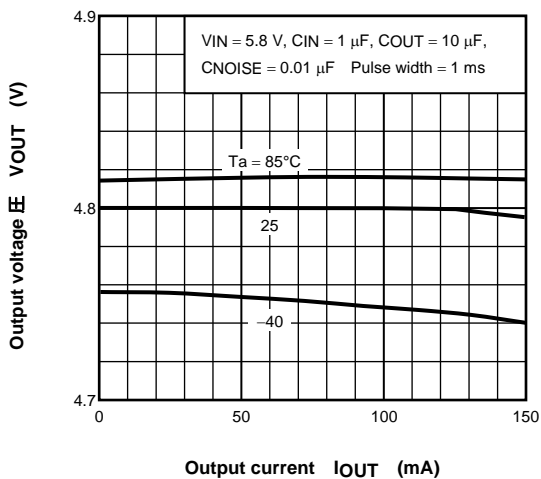

(TAR5SB50) I<sub>OUT</sub> - V<sub>OUT</sub>

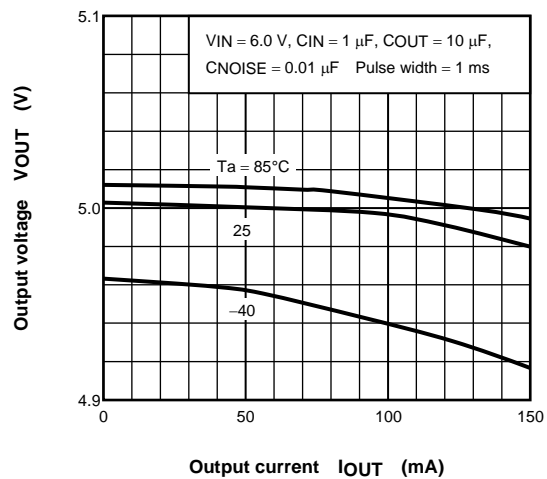

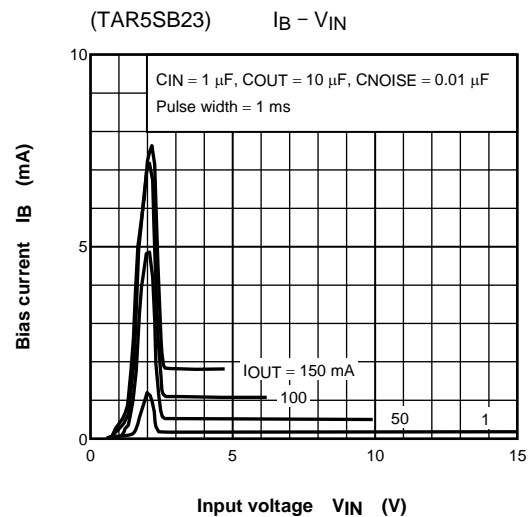
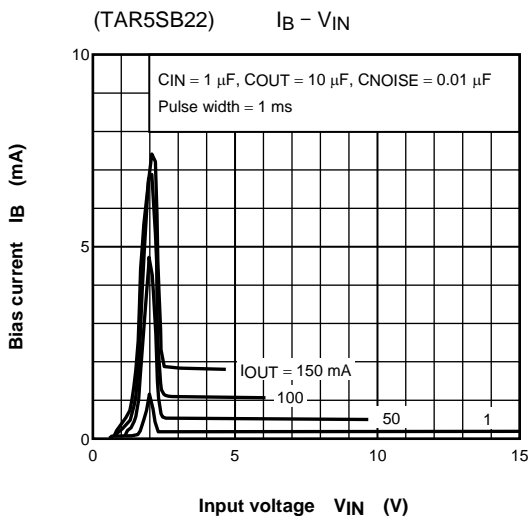
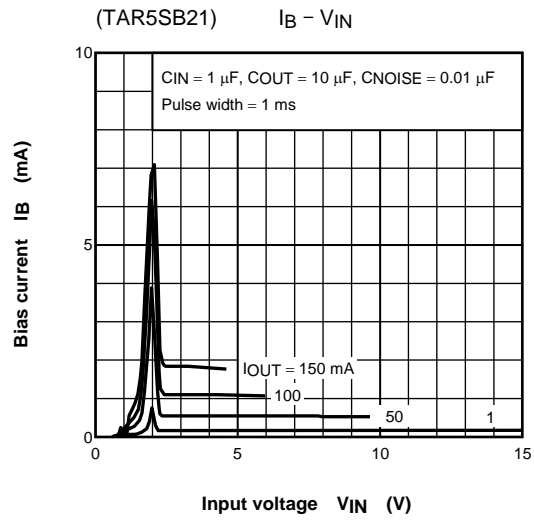
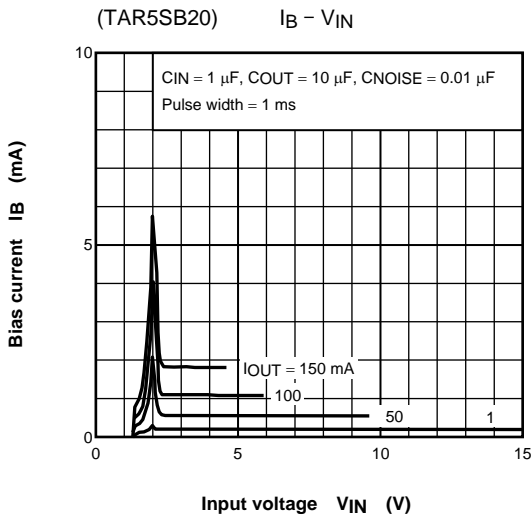
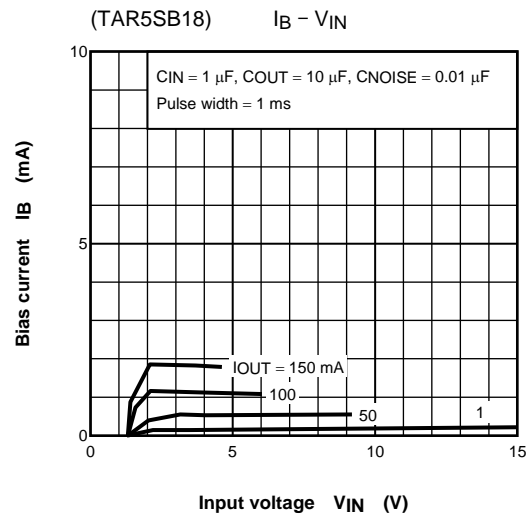
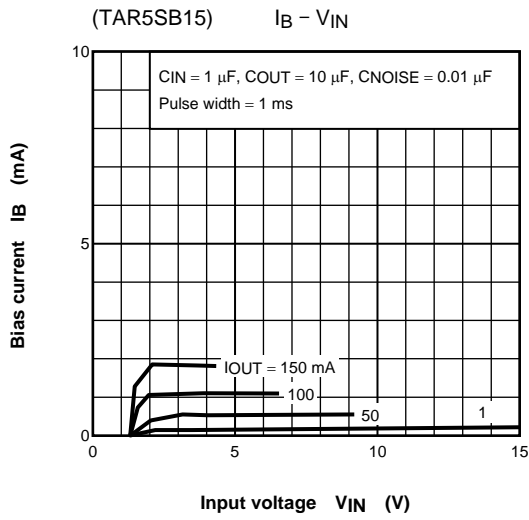

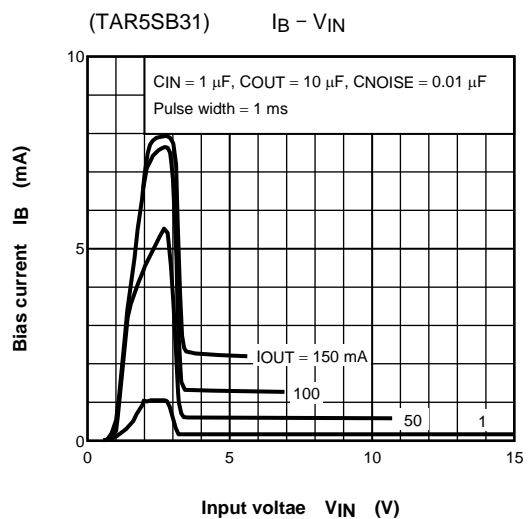
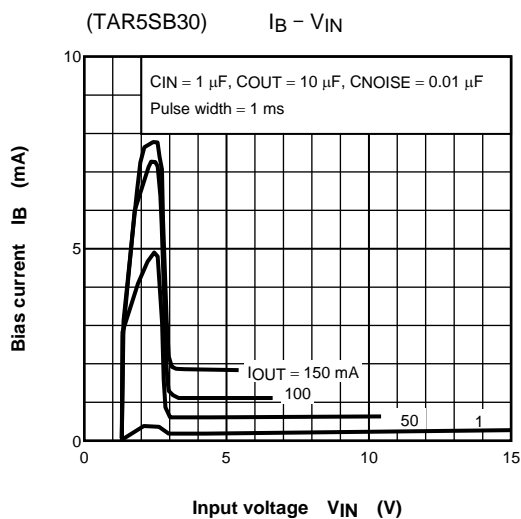
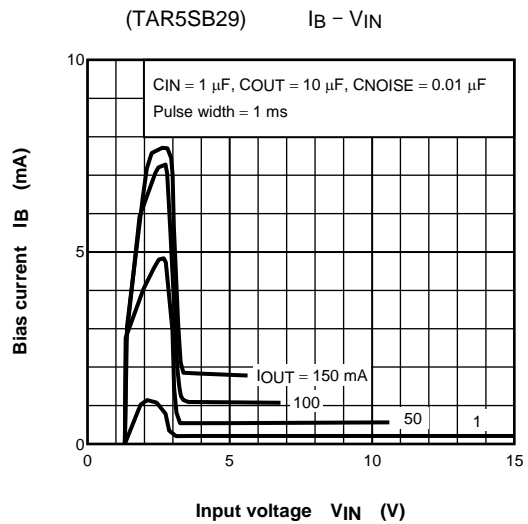
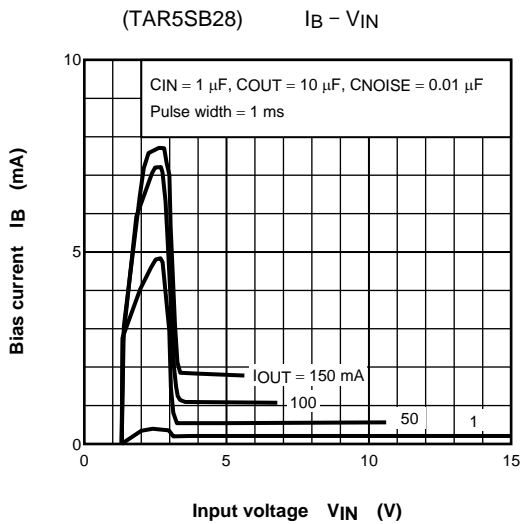
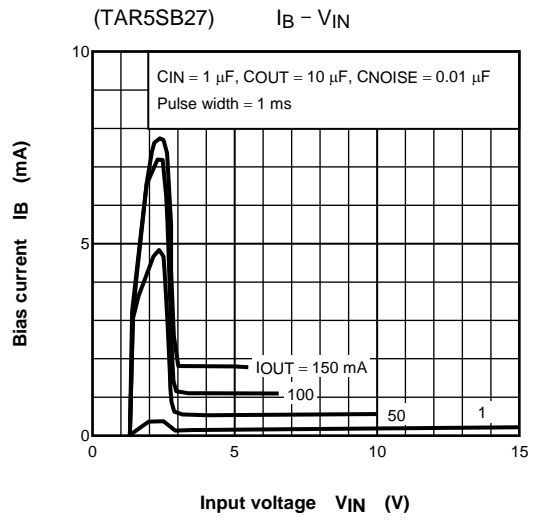
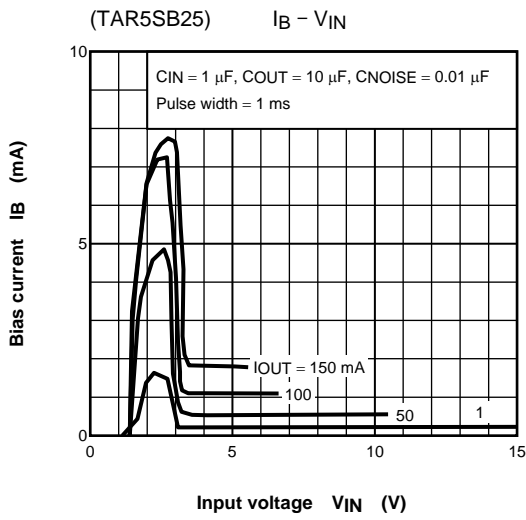

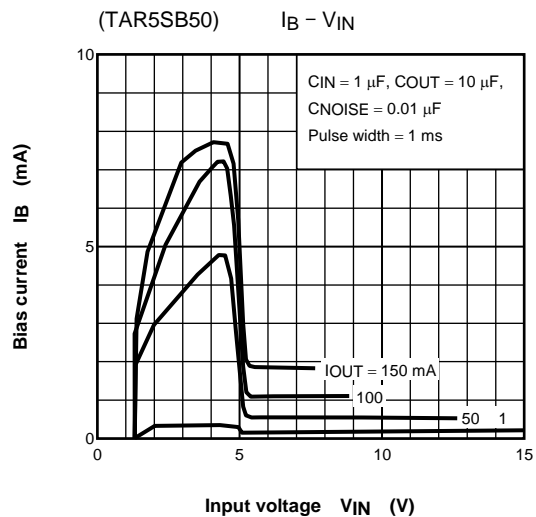
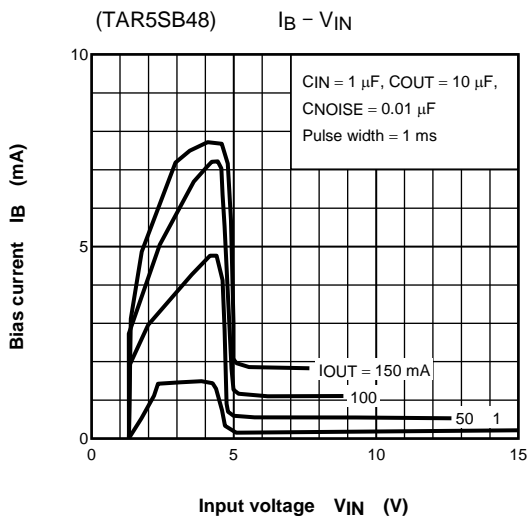
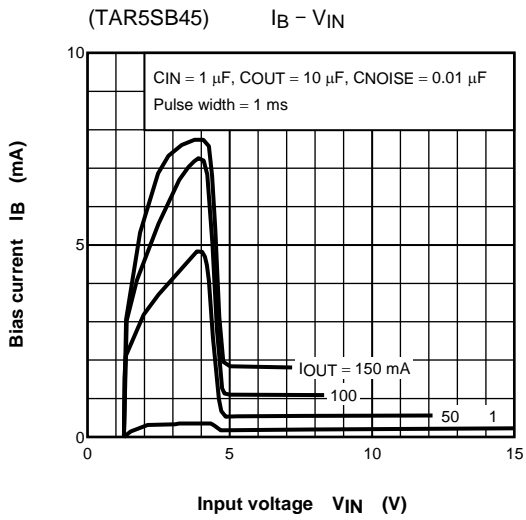
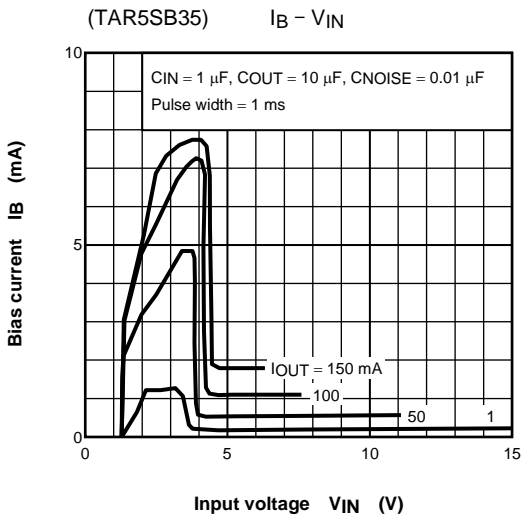
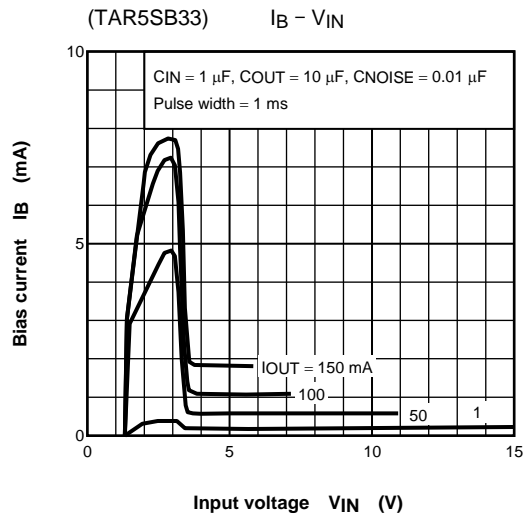
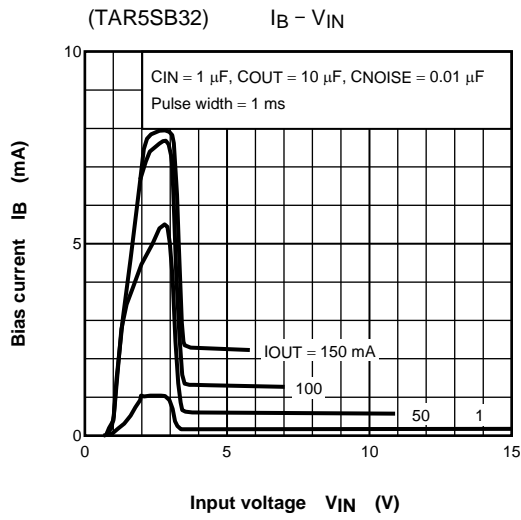

(TAR5SB15)  $V_{OUT} - V_{IN}$

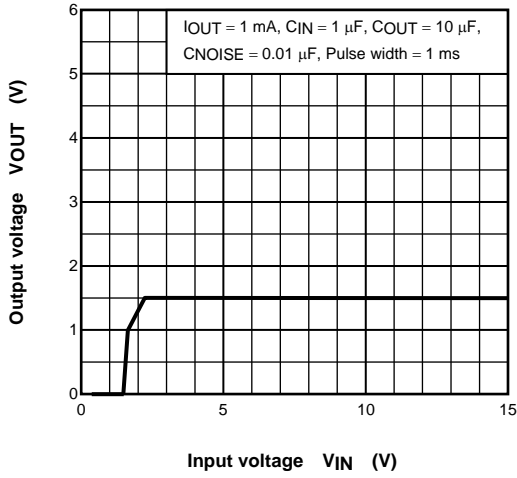

(TAR5SB18)  $V_{OUT} - V_{IN}$

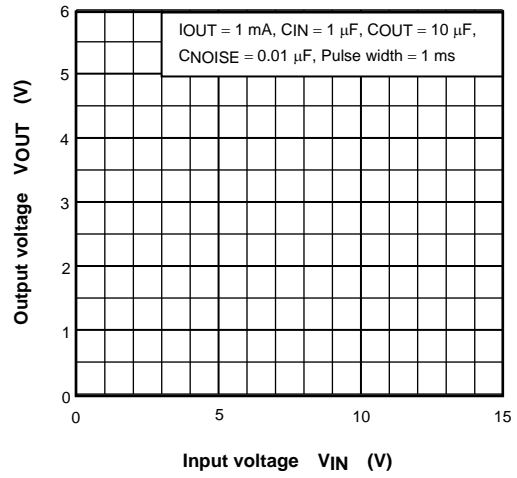

(TAR5SB20)  $V_{OUT} - V_{IN}$

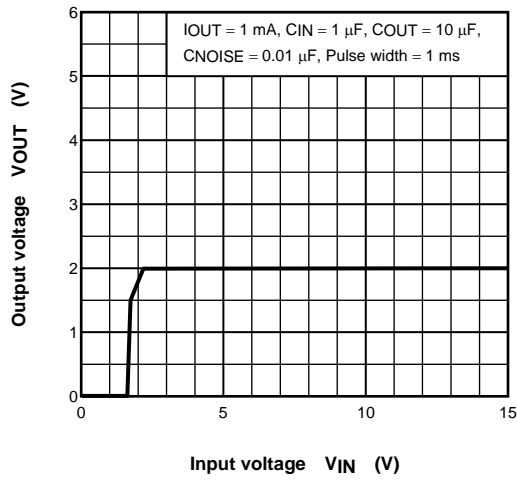

(TAR5SB21)  $V_{OUT} - V_{IN}$

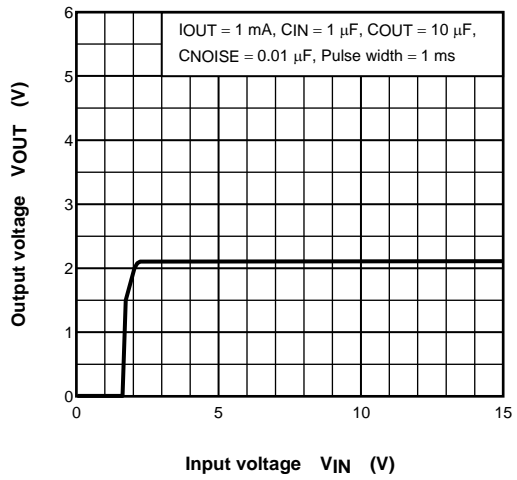

(TAR5SB22)  $V_{OUT} - V_{IN}$

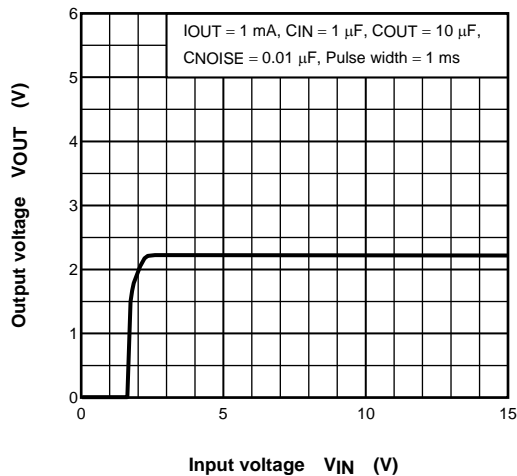

(TAR5SB23)  $V_{OUT} - V_{IN}$

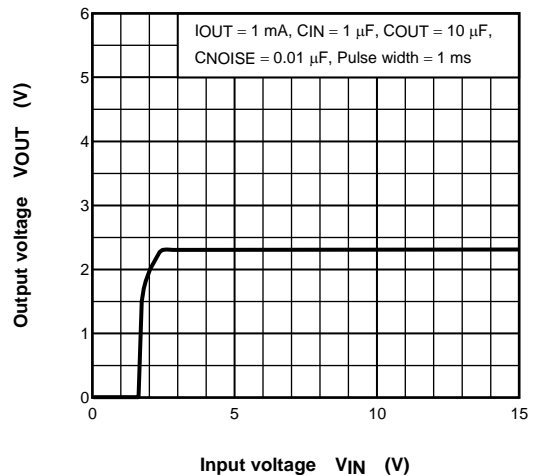

(TAR5SB25)  $V_{OUT} - V_{IN}$

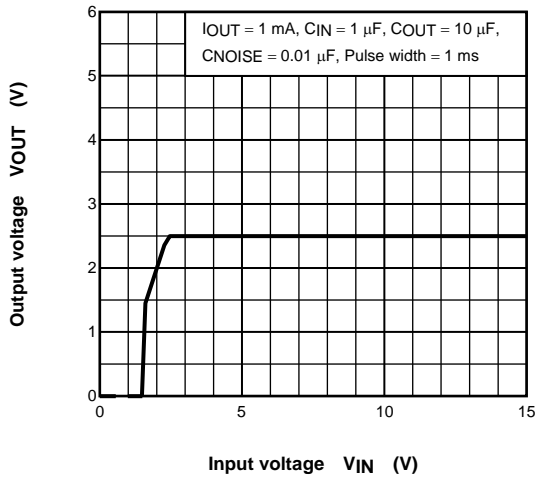

(TAR5SB27)  $V_{OUT} - V_{IN}$

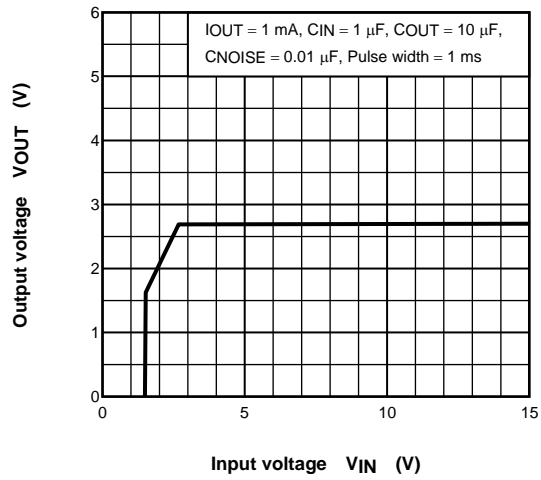

(TAR5SB28)  $V_{OUT} - V_{IN}$

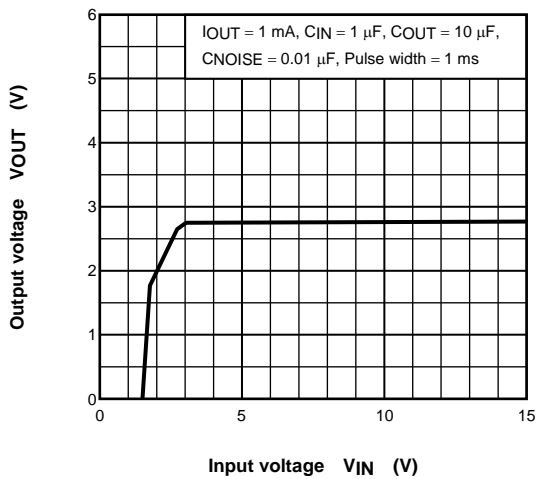

(TAR5SB29)  $V_{OUT} - V_{IN}$

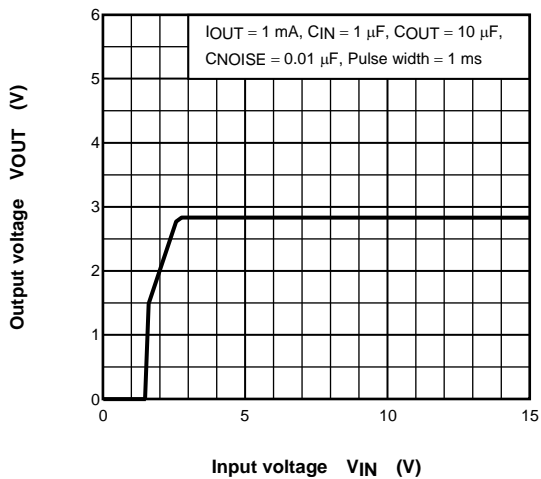

(TAR5SB30)  $V_{OUT} - V_{IN}$

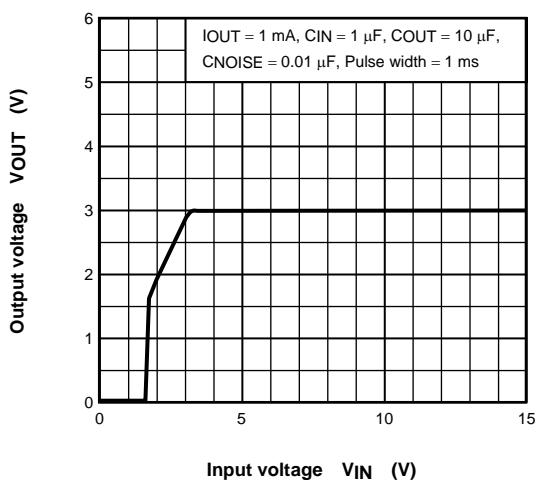

(TAR5SB31)  $V_{OUT} - V_{IN}$

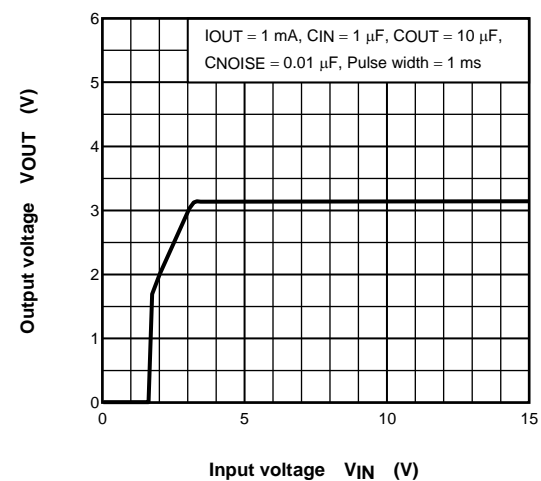

(TAR5SB32)  $V_{OUT} - V_{IN}$

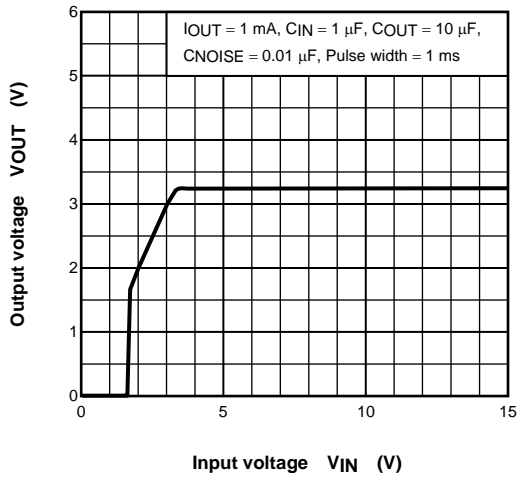

(TAR5SB33)  $V_{OUT} - V_{IN}$

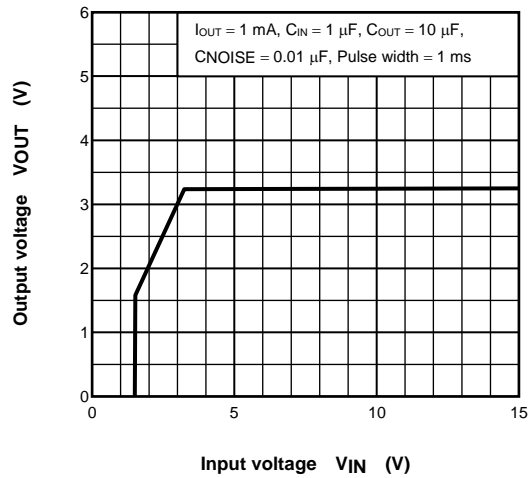

(TAR5SB35)  $V_{OUT} - V_{IN}$

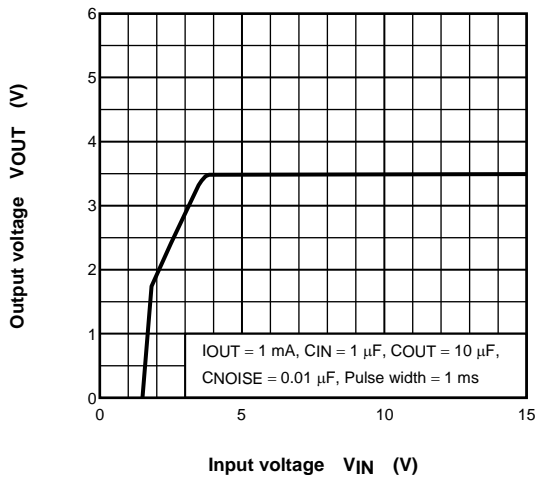

(TAR5SB45)  $V_{OUT} - V_{IN}$

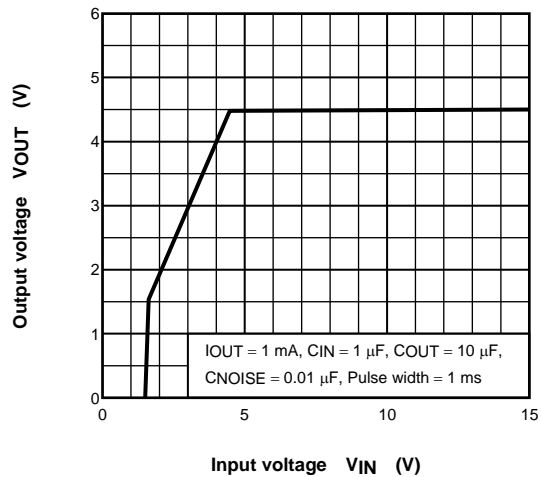

(TAR5SB48)  $V_{OUT} - V_{IN}$

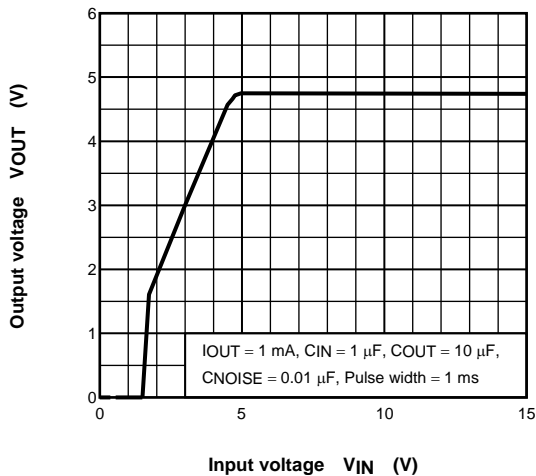

(TAR5SB50)  $V_{OUT} - V_{IN}$

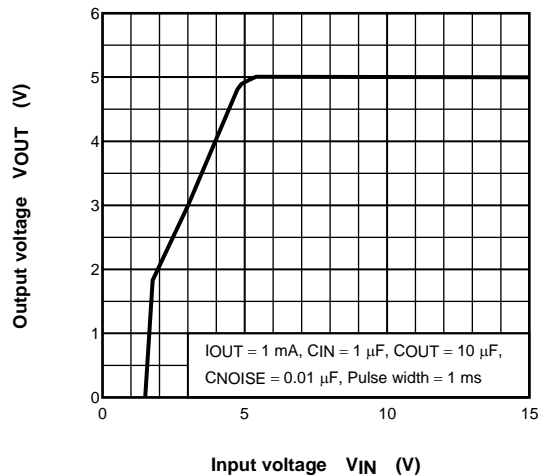



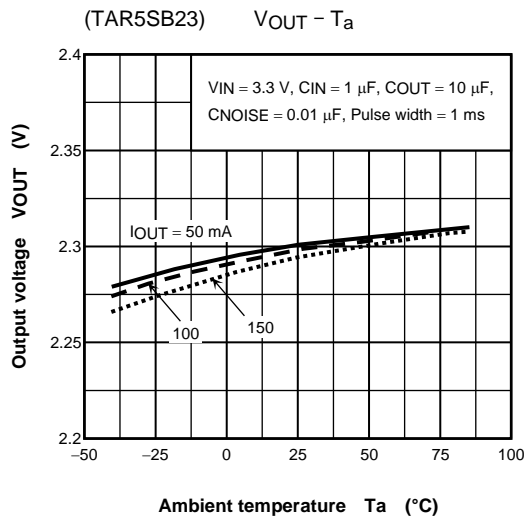
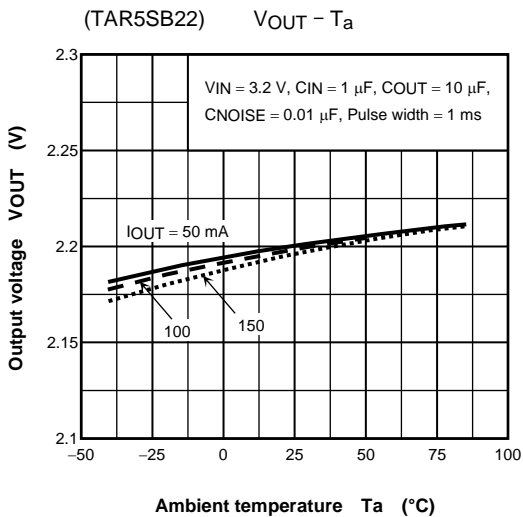
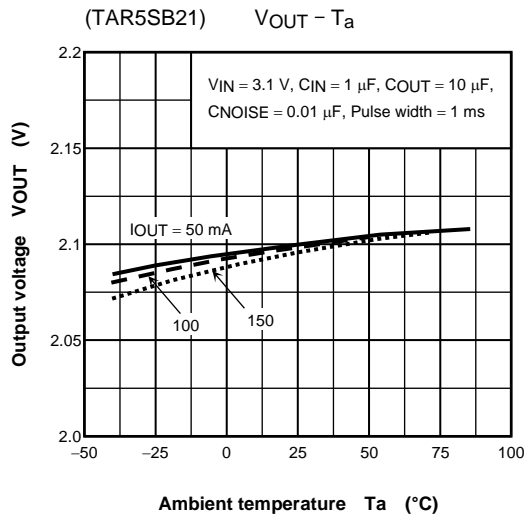
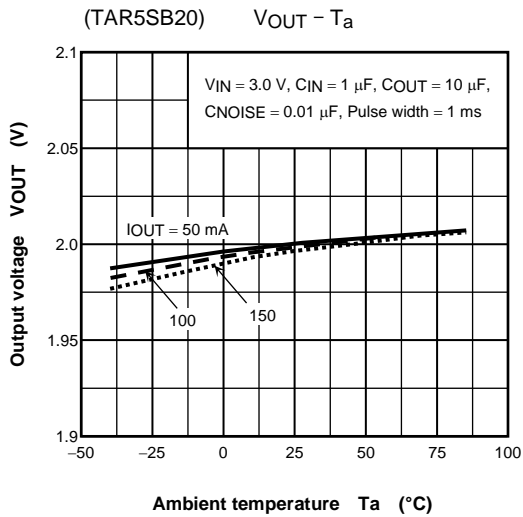
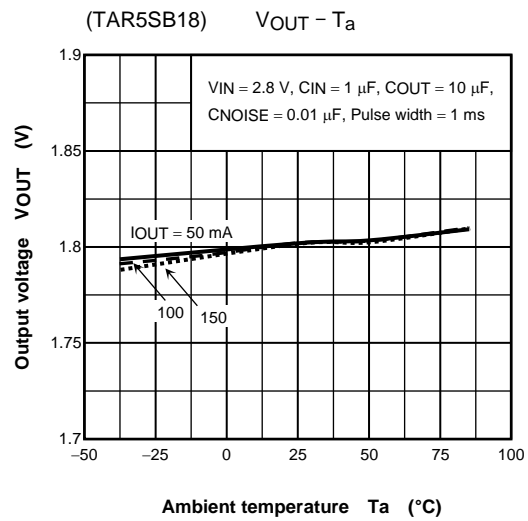
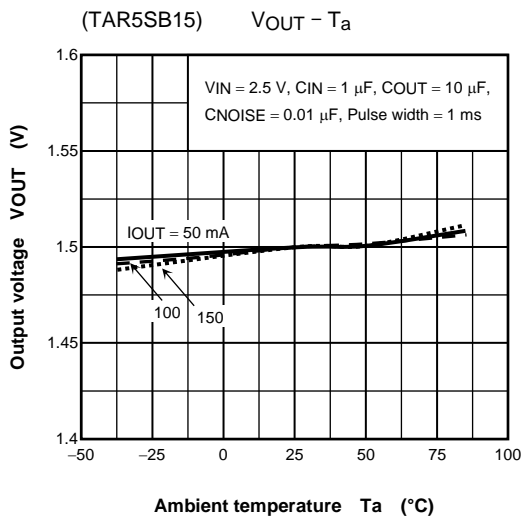

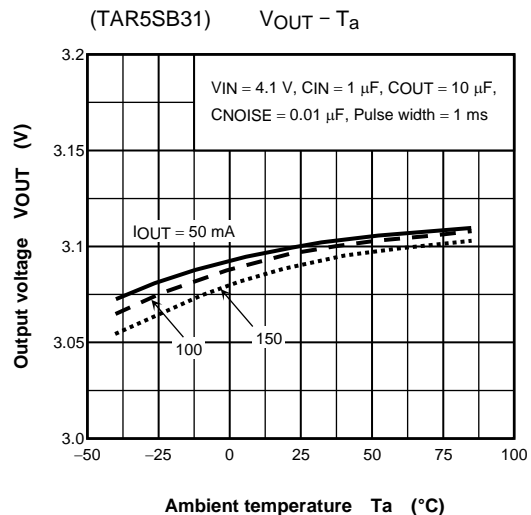
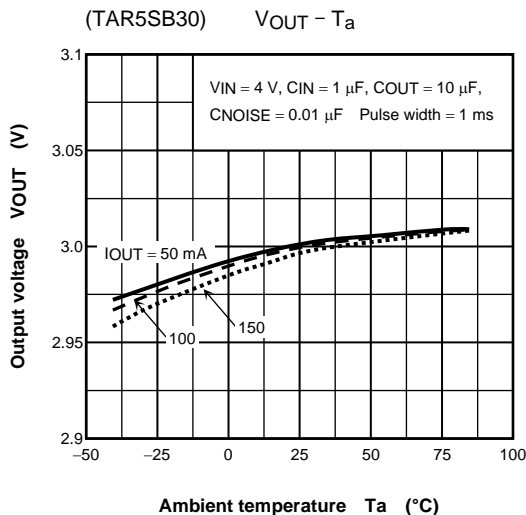
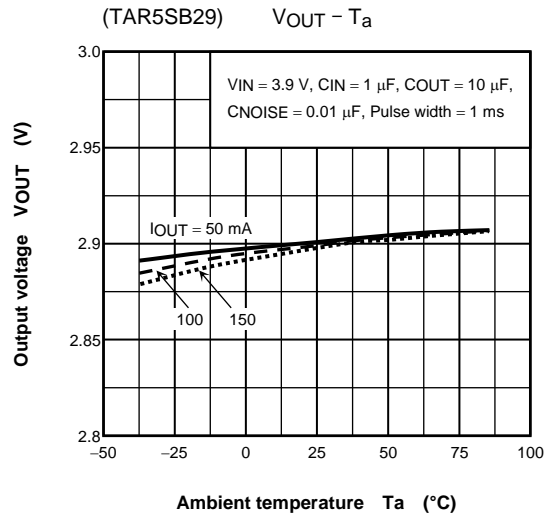
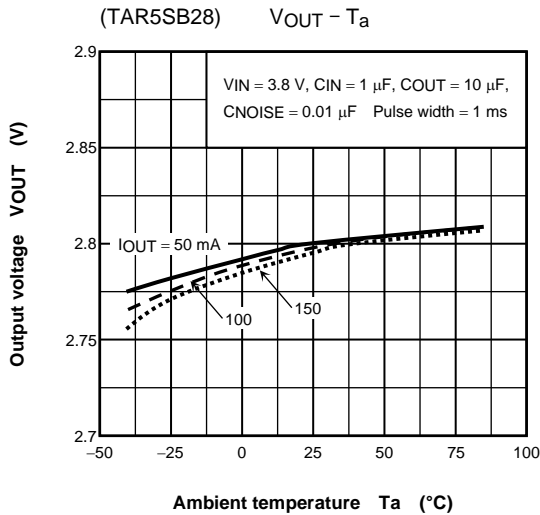
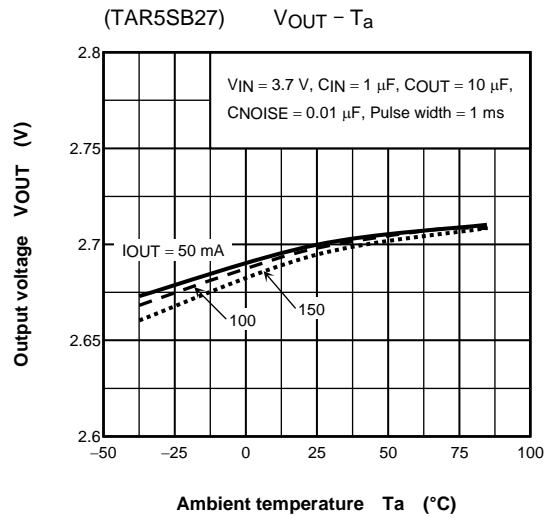
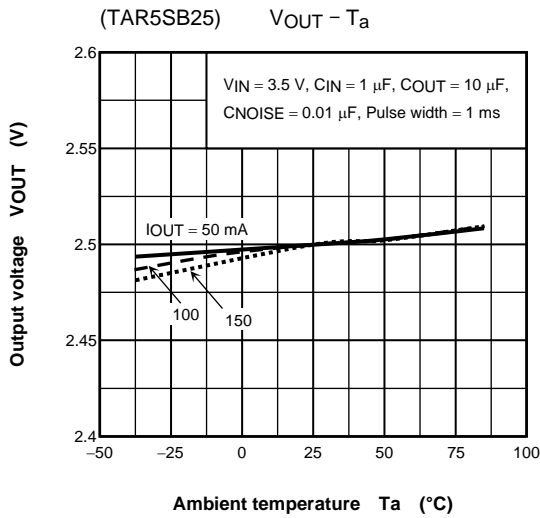

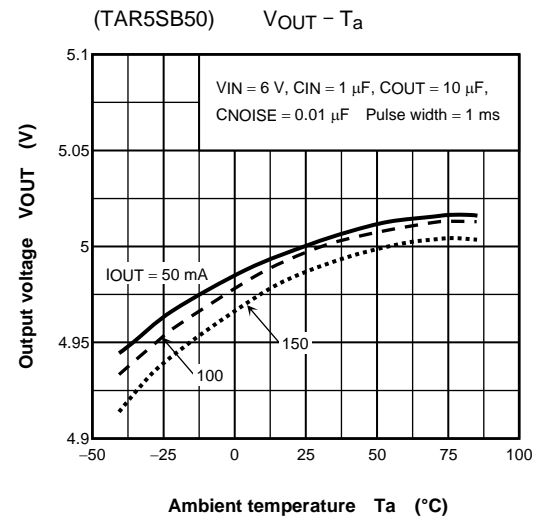
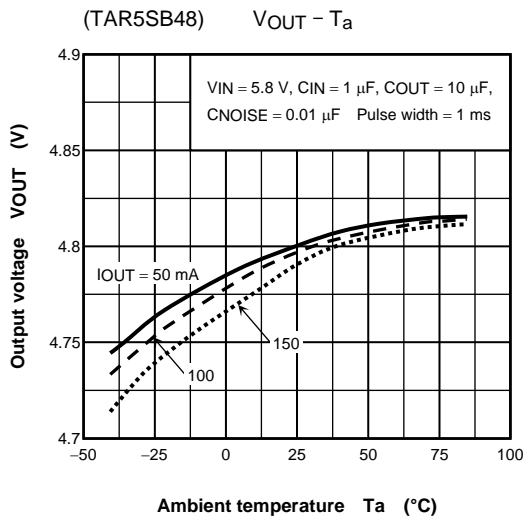
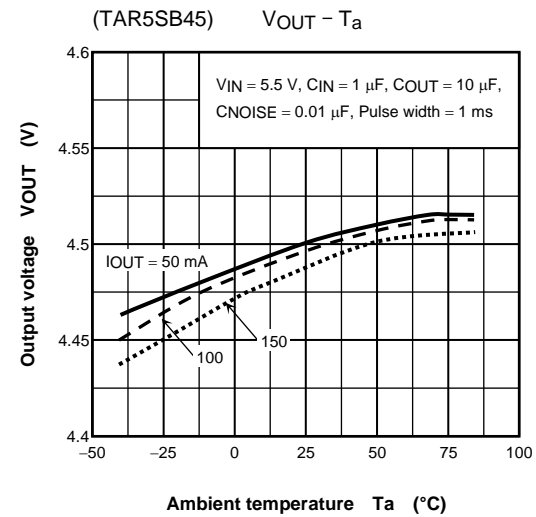
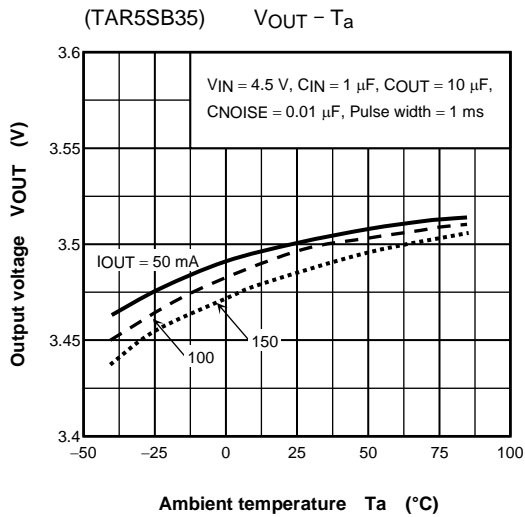
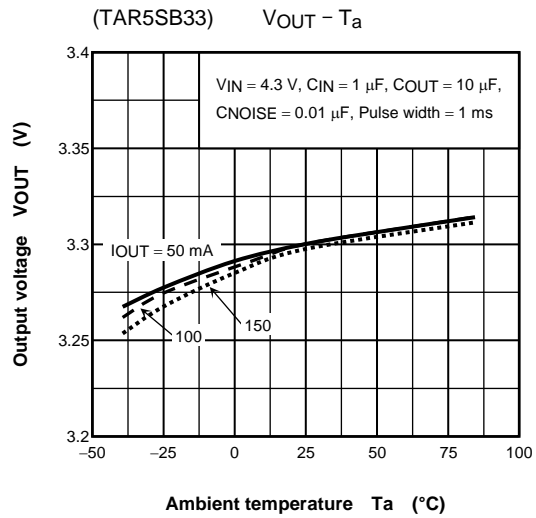
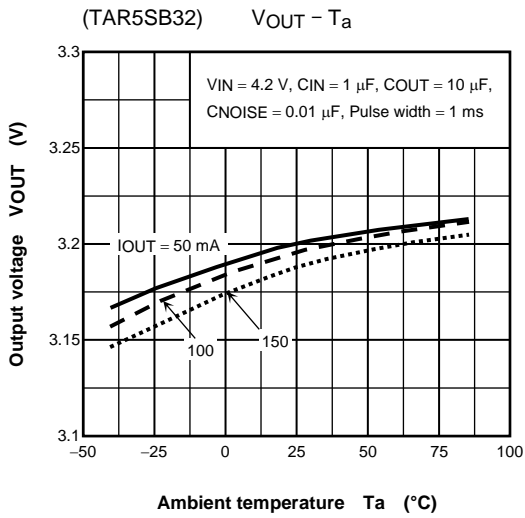

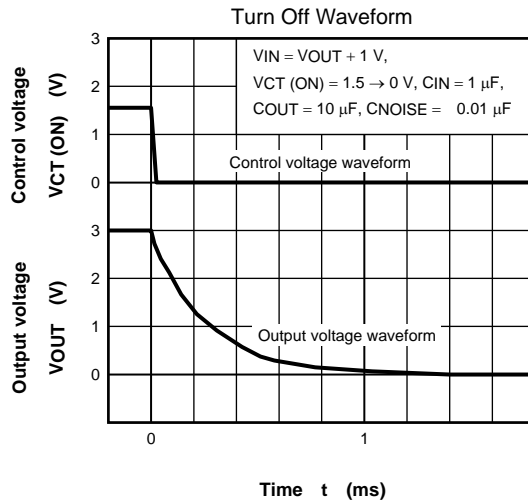
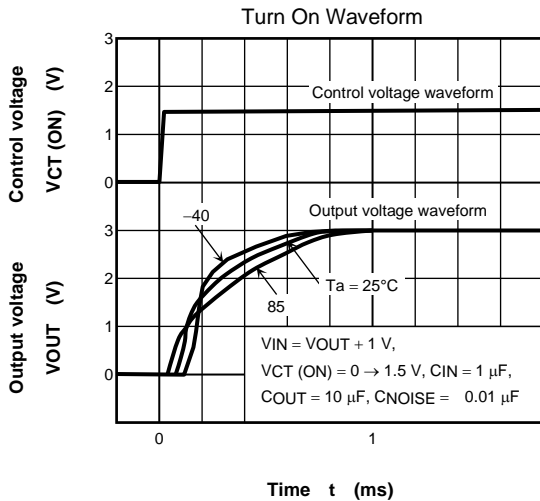
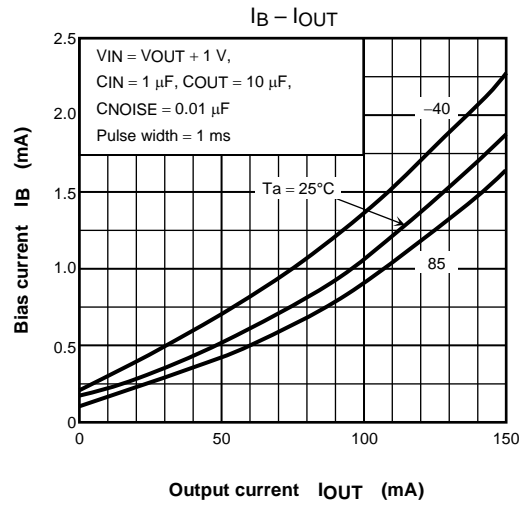
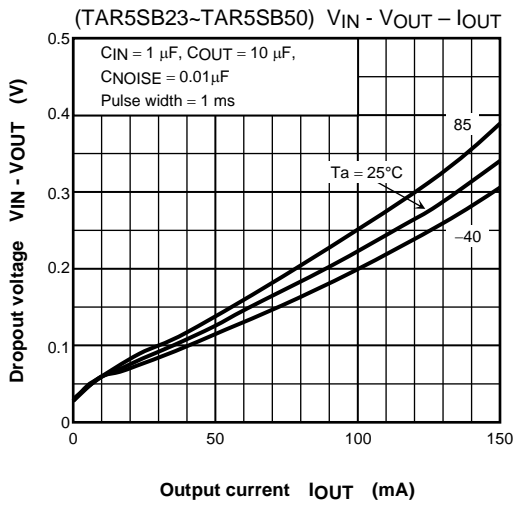
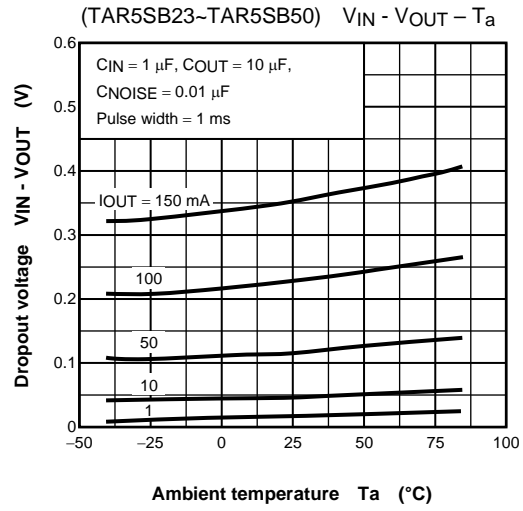
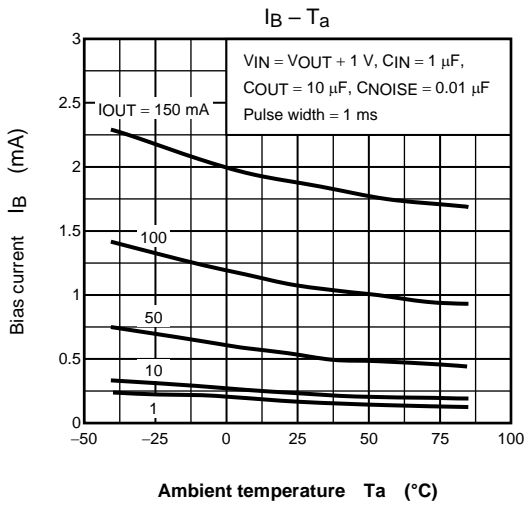

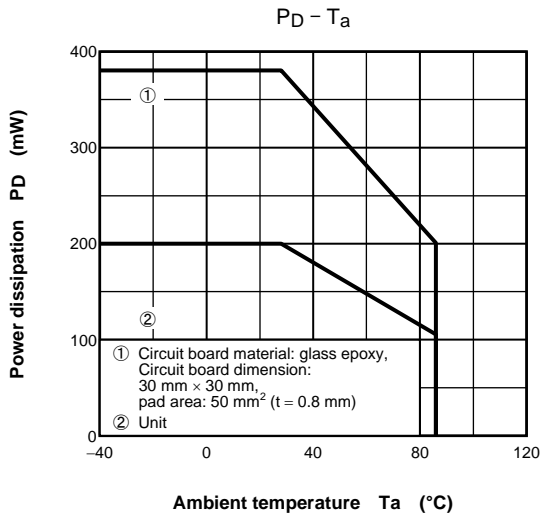
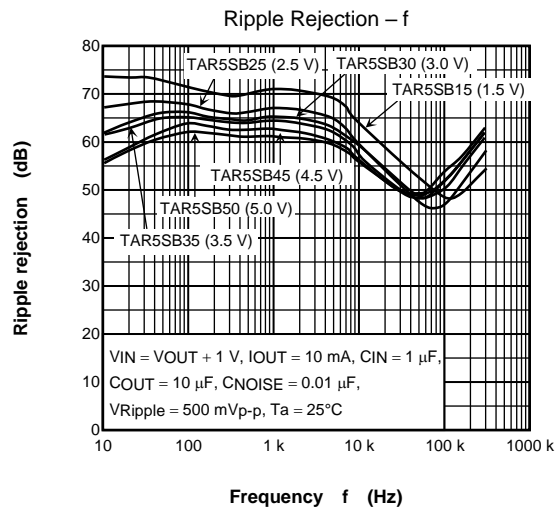
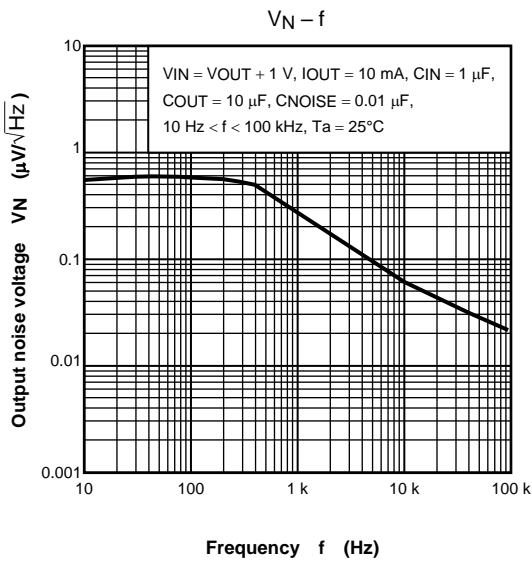

Note: The above characteristics curves are presented for reference only and not guaranteed by production test, unless otherwise noted.

## 8. Package Information

SSOP5-P-0.95 (SMV)

Unit: mm

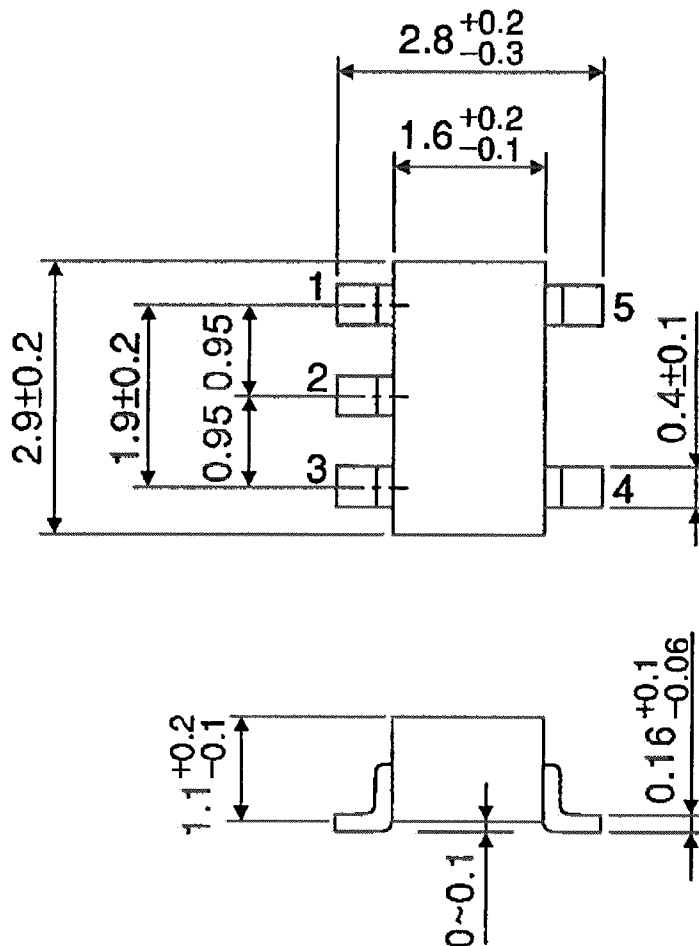

Weight: 0.014 g (typ.)

## RESTRICTIONS ON PRODUCT USE

Toshiba Corporation and its subsidiaries and affiliates are collectively referred to as "TOSHIBA". Hardware, software and systems described in this document are collectively referred to as "Product".

- TOSHIBA reserves the right to make changes to the information in this document and related Product without notice.
- This document and any information herein may not be reproduced without prior written permission from TOSHIBA. Even with TOSHIBA's written permission, reproduction is permissible only if reproduction is without alteration/omission.
- Though TOSHIBA works continually to improve Product's quality and reliability, Product can malfunction or fail. Customers are responsible for complying with safety standards and for providing adequate designs and safeguards for their hardware, software and systems which minimize risk and avoid situations in which a malfunction or failure of Product could cause loss of human life, bodily injury or damage to property, including data loss or corruption. Before customers use the Product, create designs including the Product, or incorporate the Product into their own applications, customers must also refer to and comply with (a) the latest versions of all relevant TOSHIBA information, including without limitation, this document, the specifications, the data sheets and application notes for Product and the precautions and conditions set forth in the "TOSHIBA Semiconductor Reliability Handbook" and (b) the instructions for the application with which the Product will be used with or for. Customers are solely responsible for all aspects of their own product design or applications, including but not limited to (a) determining the appropriateness of the use of this Product in such design or applications; (b) evaluating and determining the applicability of any information contained in this document, or in charts, diagrams, programs, algorithms, sample application circuits, or any other referenced documents; and (c) validating all operating parameters for such designs and applications. **TOSHIBA ASSUMES NO LIABILITY FOR CUSTOMERS' PRODUCT DESIGN OR APPLICATIONS.**
- **PRODUCT IS NEITHER INTENDED NOR WARRANTED FOR USE IN EQUIPMENTS OR SYSTEMS THAT REQUIRE EXTRAORDINARILY HIGH LEVELS OF QUALITY AND/OR RELIABILITY, AND/OR A MALFUNCTION OR FAILURE OF WHICH MAY CAUSE LOSS OF HUMAN LIFE, BODILY INJURY, SERIOUS PROPERTY DAMAGE AND/OR SERIOUS PUBLIC IMPACT ("UNINTENDED USE").** Except for specific applications as expressly stated in this document, Unintended Use includes, without limitation, equipment used in nuclear facilities, equipment used in the aerospace industry, lifesaving and/or life supporting medical equipment, equipment used for automobiles, trains, ships and other transportation, traffic signaling equipment, equipment used to control combustions or explosions, safety devices, elevators and escalators, and devices related to power plant. **IF YOU USE PRODUCT FOR UNINTENDED USE, TOSHIBA ASSUMES NO LIABILITY FOR PRODUCT.** For details, please contact your TOSHIBA sales representative or contact us via our website.
- Do not disassemble, analyze, reverse-engineer, alter, modify, translate or copy Product, whether in whole or in part.
- Product shall not be used for or incorporated into any products or systems whose manufacture, use, or sale is prohibited under any applicable laws or regulations.
- The information contained herein is presented only as guidance for Product use. No responsibility is assumed by TOSHIBA for any infringement of patents or any other intellectual property rights of third parties that may result from the use of Product. No license to any intellectual property right is granted by this document, whether express or implied, by estoppel or otherwise.
- **ABSENT A WRITTEN SIGNED AGREEMENT, EXCEPT AS PROVIDED IN THE RELEVANT TERMS AND CONDITIONS OF SALE FOR PRODUCT, AND TO THE MAXIMUM EXTENT ALLOWABLE BY LAW, TOSHIBA (1) ASSUMES NO LIABILITY WHATSOEVER, INCLUDING WITHOUT LIMITATION, INDIRECT, CONSEQUENTIAL, SPECIAL, OR INCIDENTAL DAMAGES OR LOSS, INCLUDING WITHOUT LIMITATION, LOSS OF PROFITS, LOSS OF OPPORTUNITIES, BUSINESS INTERRUPTION AND LOSS OF DATA, AND (2) DISCLAIMS ANY AND ALL EXPRESS OR IMPLIED WARRANTIES AND CONDITIONS RELATED TO SALE, USE OF PRODUCT, OR INFORMATION, INCLUDING WARRANTIES OR CONDITIONS OF MERCHANTABILITY, FITNESS FOR A PARTICULAR PURPOSE, ACCURACY OF INFORMATION, OR NONINFRINGEMENT.**
- Do not use or otherwise make available Product or related software or technology for any military purposes, including without limitation, for the design, development, use, stockpiling or manufacturing of nuclear, chemical, or biological weapons or missile technology products (mass destruction weapons). Product and related software and technology may be controlled under the applicable export laws and regulations including, without limitation, the Japanese Foreign Exchange and Foreign Trade Law and the U.S. Export Administration Regulations. Export and re-export of Product or related software or technology are strictly prohibited except in compliance with all applicable export laws and regulations.
- Please contact your TOSHIBA sales representative for details as to environmental matters such as the RoHS compatibility of Product. Please use Product in compliance with all applicable laws and regulations that regulate the inclusion or use of controlled substances, including without limitation, the EU RoHS Directive. **TOSHIBA ASSUMES NO LIABILITY FOR DAMAGES OR LOSSES OCCURRING AS A RESULT OF NONCOMPLIANCE WITH APPLICABLE LAWS AND REGULATIONS.**