



MPA-395THTP0

MPA

POSITION SENSORS

SICK
Sensor Intelligence.



Ordering information

Type	Part no.
MPA-395THTP0	1059458

Other models and accessories → www.sick.com/MPA



Detailed technical data

Features

Cylinder type	Universal
Cylinder types with adapter	Round body cylinder Tie rod cylinder T-slot cylinders Festo cylinders DSBC SMC cylinders CP96
Measuring range	395 mm ¹⁾
Housing length	397 mm
Output function	Analog, IO-Link
Electrical wiring	DC 4-wire
Analog output (voltage)	0 V ... 10 V
Analog output (current)	4 mA ... 20 mA ²⁾
Enclosure rating	IP65, IP67, IP68 ³⁾
IO-Link functions	Standard functions
Adjustment	
Teach-in control panel	Teaching in the measuring range Selecting the current/voltage output or IO-Link Resetting the measuring range to factory settings
IO-Link	Teaching in the measuring range Resetting the measuring range

¹⁾ ± 1 mm.

²⁾ Default setting: Current output active.

³⁾ According to EN 60529.

Mechanics/electronics

Supply voltage	15 V DC ... 30 V DC
Power consumption	35 mA, without load
Max. load resistance	≤ 500 Ω Power Output, at 24 V
Min. load resistance	≥ 2 kΩ ¹⁾
Protection class	III
Required magnetic field sensitivity, typ.	2 mT ... 15 mT
Resolution, typ.	0.03 % FSR (max. ≥ 0.06 mm) ^{2) 3)}
Linearity error, typ.	0.5 mm ⁴⁾
Repeat accuracy, typ.	0.06 % FSR (≥ 0.1 mm) ⁵⁾
Sampling rate, typ.	1.15 ms ⁶⁾
Reverse polarity protection	Yes
Short-circuit protection	Yes
Status indicator LED	Yes
Teach-in	Yes
Ambient operating temperature	-20 °C ... +70 °C
Shock and vibration resistance	30 g, 11 ms/10 Hz ... 55 Hz, 1 mm
EMC	According to EN 60947-5-2 ⁷⁾
Connection type	Cable with M8 male connector, 4-pin, 0.3 m
Connection type Detail	
Deep-freeze property	Do not bend below 0 °C
Conductor cross section	0.08 mm ²
Cable diameter	Ø 2.6 mm
Bending radius	With fixed installation > 5 x cable diameter For flexible use > 10 x cable diameter
Cable outlet	Axial
Material	
Housing	Metal, Aluminum, plastic
Cable	PUR
UL File No.	NRKH.E181493 & NRKH7.E181493

¹⁾ Voltage output.

²⁾ FSR: Full Scale Range; max. measuring range.

³⁾ When using IO-Link, the resolution is 0.25 mm.

⁴⁾ At 25 °C, linearity error (maximum deviation) depending on response curve and minimal deviation function.

⁵⁾ At 25 °C, repeatability magnet movement in one direction.

⁶⁾ Only in standard mode, not in IO-Link mode.

⁷⁾ The analog measured value can deviate under transient conditions.

Safety-related parameters

MTTF_D	147 years
DC_{avg}	0 %
T_M (mission time)	20 years

Communication interface

Communication interface	IO-Link V1.0.1
Communication Interface detail	COM2
Cycle time	2.3 ms
Process data length	16 Bit
Process data structure	Bit 0 ... 3 = reserved Bit 4 ... 5 = position (after decimal point) Bit 6 ... 15 = position (before decimal point)

Classifications

ECLASS 5.0	27270104
ECLASS 5.1.4	27270104
ECLASS 6.0	27270104
ECLASS 6.2	27270104
ECLASS 7.0	27270104
ECLASS 8.0	27270104
ECLASS 8.1	27270104
ECLASS 9.0	27270104
ECLASS 10.0	27270104
ECLASS 11.0	27270104
ECLASS 12.0	27274301
ETIM 5.0	EC002544
ETIM 6.0	EC002544
ETIM 7.0	EC002544
ETIM 8.0	EC002544
UNSPSC 16.0901	39122230

Connection diagram

Cd-230

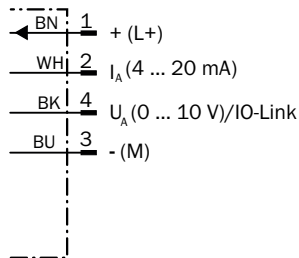

Dimensional drawing (Dimensions in mm (inch))

Cable with M8 male connector, 4-pin

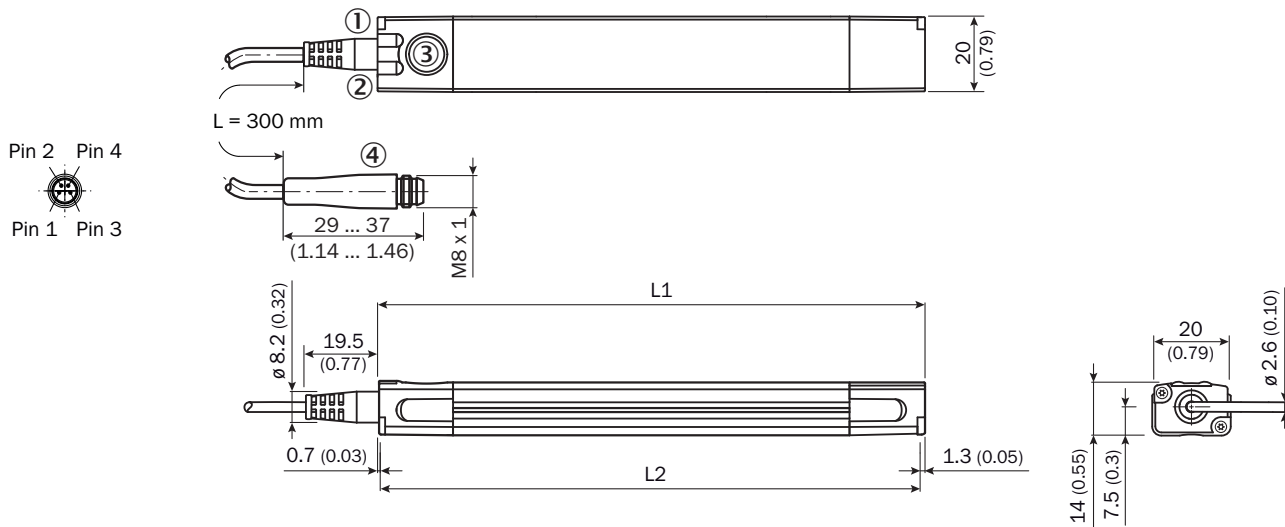

	Total length (L1) mm	Measuring range (L2) mm		Total length (L1) mm	Measuring range (L2) mm
MPA-107	109	107	MPA-575	577	575
MPA-143	145	143	MPA-611	613	611
MPA-179	181	179	MPA-647	649	647
MPA-215	217	215	MPA-683	685	683
MPA-251	253	251	MPA-719	721	719
MPA-287	289	287	MPA-755	757	755
MPA-323	325	323	MPA-791	793	791
MPA-359	361	359	MPA-827	829	827
MPA-395	397	395	MPA-863	865	863
MPA-431	433	431	MPA-899	901	899
MPA-467	469	467	MPA-935	937	935
MPA-503	505	503	MPA-971	973	971
MPA-539	541	539	MPA-1007	1,009	1,007





- ① Function signal indicator 1
- ② Function signal indicator 2
- ③ Teach-Pad
- ④ Connection

Recommended accessories

Other models and accessories → www.sick.com/MPA

	Brief description	Type	Part no.
Magnets			
	Magnet with mounting hole for M3 countersunk screw, Ø 15.2 mm, height 6 mm	Magnet	5327349

	Brief description	Type	Part no.
Brackets for cylinder sensors			
	Sensor adapter DSBC-32, Stainless steel V2A	BEF-KHZPF032MPA	2086744
	Sensor adapter DSBC-40, Stainless steel V2A	BEF-KHZPF040MPA	2086745
	Sensor adapter DSBC-50, Stainless steel V2A	BEF-KHZPF050MPA	2086746
	Sensor adapter DSBC-63, Stainless steel V2A	BEF-KHZPF063MPA	2086747
	Sensor adapter DSBC-80, Stainless steel V2A	BEF-KHZPF080MPA	2086748
	Sensor adapter DSBC-100, Stainless steel V2A	BEF-KHZPF100MPA	2086749
	Sensor adapter DSBC-125, Stainless steel V2A	BEF-KHZPF125MPA	2086750
	For tie-rod cylinder (diameter tie-rod max. 18 mm), Aluminum alloy (adapter), Stainless steel V2A (mounting-/fixing screw)	BEF-KHZPZ1MPA	2065578
	For round body cylinders with diameter up to 85 mm, Stainless steel V2A	BEF-KHZR085MPA	2066626
	For round body cylinders with diameter up to 135 mm, Stainless steel V2A	BEF-KHZR135MPA	2066627
	For round body cylinders with diameter up to 210 mm, Stainless steel V2A	BEF-KHZR210MPA	2066628
	Sensor adapter CP96-63, Stainless steel V2A	BEF-KHZTS063MPA	2086756
	Sensor adapter CP96-80, Stainless steel V2A	BEF-KHZTS080MPA	2086757
	Sensor adapter CP96-100, Stainless steel V2A	BEF-KHZTS100MPA	2086758
	Sensor adapter CP96-125, Stainless steel V2A	BEF-KHZTS125MPA	2086759
	For T-slot cylinders, Stainless steel V2A (bracket/mounting screw), Brass (fixing screw/sliding nut)	BEF-KHZT01MPA	2065575
Mounting brackets and plates			
	Bracket for low mounting, Stainless steel V2A (bracket/mounting screw), Brass (fixing screw)	BEF-WNL01MPA	2065973
	Bracket for lateral mounting, Stainless steel V2A (bracket/mounting screw), Brass (fixing screw)	BEF-WNZ01MPA	2065577
Other mounting accessories			
	10 pieces, Label Holder, 2.5 mm to 3.5 mm, 10 pcs., TPU	LABEL HOLDER	2086019
Plug connectors and cables			
	<ul style="list-style-type: none"> • Connection type head A: Female connector, M8, 4-pin, straight, A-coded • Connection type head B: Flying leads • Signal type: Sensor/actuator cable • Cable: 2 m, 4-wire, PUR, halogen-free • Description: Sensor/actuator cable, unshielded • Application: Zones with oils and lubricants, Drag chain operation, Robot 	YF8U14-020UA3XLEAX	2094791
	<ul style="list-style-type: none"> • Connection type head A: Female connector, M8, 4-pin, straight, A-coded • Connection type head B: Flying leads • Signal type: Sensor/actuator cable • Cable: 5 m, 4-wire, PUR, halogen-free • Description: Sensor/actuator cable, unshielded • Application: Zones with oils and lubricants, Drag chain operation, Robot 	YF8U14-050UA3XLEAX	2094792

	Brief description	Type	Part no.
	<ul style="list-style-type: none"> • Connection type head A: Female connector, M8, 4-pin, angled, A-coded • Connection type head B: Flying leads • Signal type: Sensor/actuator cable • Cable: 2 m, 4-wire, PUR, halogen-free • Description: Sensor/actuator cable, unshielded • Application: Zones with oils and lubricants, Drag chain operation, Robot 	YG8U14-020UA3XLEAX	2095589
	<ul style="list-style-type: none"> • Connection type head A: Female connector, M8, 4-pin, angled, A-coded • Connection type head B: Flying leads • Signal type: Sensor/actuator cable • Cable: 5 m, 4-wire, PUR, halogen-free • Description: Sensor/actuator cable, unshielded • Application: Zones with oils and lubricants, Drag chain operation, Robot 	YG8U14-050UA3XLEAX	2095590
	<ul style="list-style-type: none"> • Connection type head A: Female connector, M8, 4-pin, straight • Description: Unshielded • Connection systems: Screw-type terminals • Permitted cross-section: 0.14 mm² ... 0.5 mm² 	DOS-0804-G	6009974
	<ul style="list-style-type: none"> • Connection type head A: Female connector, M8, 4-pin, angled • Description: Unshielded • Connection systems: Solder connection • Permitted cross-section: ≤ 0.25 mm² 	DOS-0804-W	6009975
	<ul style="list-style-type: none"> • Connection type head A: Male connector, M8, 4-pin, straight • Description: Unshielded • Connection systems: Screw-type terminals • Permitted cross-section: 0.14 mm² ... 0.5 mm² 	STE-0804-G	6037323

Recommended services

Additional services → www.sick.com/MPA

	Type	Part no.
Function Block Factory		
<ul style="list-style-type: none"> • Description: The Function Block Factory supports common programmable logic controllers (PLCs) from various manufacturers, such as Siemens, Beckhoff, Rockwell Automation and B&R. More information on the FBF can be found here. • Note: You can configure your function block at Function Block Factory. As a login please use your SICK ID. 	Function Block Factory	On request

SICK AT A GLANCE

SICK is one of the leading manufacturers of intelligent sensors and sensor solutions for industrial applications. A unique range of products and services creates the perfect basis for controlling processes securely and efficiently, protecting individuals from accidents and preventing damage to the environment.

We have extensive experience in a wide range of industries and understand their processes and requirements. With intelligent sensors, we can deliver exactly what our customers need. In application centers in Europe, Asia and North America, system solutions are tested and optimized in accordance with customer specifications. All this makes us a reliable supplier and development partner.

Comprehensive services complete our offering: SICK LifeTime Services provide support throughout the machine life cycle and ensure safety and productivity.

For us, that is “Sensor Intelligence.”

WORLDWIDE PRESENCE:

Contacts and other locations –www.sick.com