

MICRO SWITCH Miniature Precision Limit Switches

14CE Series

002387

Issue 4

Datasheet



DESCRIPTION

All MICRO SWITCH™ 14CE Series compact enclosed switches incorporate fluorocarbon diaphragm sealing to provide reliable protection, meeting IP65, IP66, IP67, and IP68, as well as NEMA 1, 2, 3, 3R, 4, 6, 6P, and 13 requirements. Versions with a boot seal also meet NEMA 12 requirements (dust, falling dirt, liquid media with solid contaminants). The cable or connector and basic switch terminals are encapsulated in an epoxy sealant, offering excellent resistance in harsh environments. For low temperature applications (down to -40 °C, -40 °F), CE Series switches can be supplied with low temperature seals and lubricant.

The CE Series switches are rugged and versatile switches which can be applied indoors in many harsh factory floor applications, as well as on outdoor equipment in extreme temperatures. A full range of actuators are available, including plain plungers, roller plungers, side rotary, multi-directional wire, and manually operated. The switches are also available with the industry standard, M12 micro-change 4-pin connector. MICRO SWITCH 14CE products meet European and Asian CE requirements.

VALUE TO CUSTOMERS

- Big performance in a small package
- Delivers consistent performance in many demanding environments where petroleum, synthetic, or water based fluids are present
- Easily customizable

FEATURES

- Rugged, compact construction means minimal real estate on equipment
- NEMA 1, 2, 3, 3R, 4, 6, 6P, 12 (boot seal), 13, and IP65/66/67/68 environmental sealing
- Pre-leaded (Cenelec cable) or supplied with a M12 four-pin connector
- Wide selection of actuators and cable length variations with side and bottom exit cable/connector options
- 25 mm mounting centers engineered with a MICRO SWITCH SM switch for consistent, precise actuation
- Well suited for up to 10 million actuation cycles (Up to 5 million actuation cycles for wobble actuators)
- Gang mounting capability to provide a multi-plunger limit switch
- Low temperature variants available for indoor and outdoor applications
- CE approvals for European and Asian use

POTENTIAL APPLICATIONS

- Machine tools
- Off-road equipment
- Material handling
- Access and mobility solutions
- Textile machinery
- Robotics
- Packaging equipment
- Commercial appliances
- Print trade machinery
- Agricultural machinery

DIFFERENTIATION

- Diaphragm seal between the actuator and the switch cavity for high performance sealing
- CE Series incorporates MICRO SWITCH SM basic switch for consistent, precise actuation
- Side exit termination for space constraints

PORTFOLIO

Honeywell's MICRO SWITCH 14CE limit switch is part of a comprehensive offering of rugged and reliable limit switches. To view the entire product portfolio, click [here](#).

MICRO SWITCH Miniature Precision Limit Switches, 14CE Series

Table 1. Specifications

Characteristic	Parameter
Description	compact enclosed limit switch
Actuators	<ul style="list-style-type: none"> • Top pin plunger (14CE1-) • Cross roller plunger (14CE3-) • Top pin plunger with boot seal (14CE18-) • Wobble (14CE20-) • Top pin plunger, panel mount (14CE27-) • Top roller plunger, parallel and panel mount (14CE28-) • Top roller plunger, perpendicular, panel mount (14CE29-) • Top roller plunger, parallel and boot sealed (14CE31-) • Top roller plunger, perpendicular, boot seal (14CE55-) • Parallel roller plunger (14CE2-) • Front rotary (14CE16-) • Top adjustable plunger (14CE19-) • Manually operated (14CE22-) • Ball bearing plunger (14CE66-)
Terminations	Harmonized Cenelec PVC sheathed 4 x 0,75 mm ² (18 AWG) cable Connector (dc), 4-pin male, M12 thread (-Q) Connector (ac), 4-pin male, 1/2 in x 20 thread (-Q1)
Switching options	SPDT, snap action contacts (1NC/1NO) Form C
Sealing	IP65, IP66, IP67, IP68* NEMA 1, 2, 3, 3R, 4, 6, 6P, 12 (boot seal), 13
Operating temperature	0 °C to 70 °C [32 °F to 158 °F]; optional -40 °C to 70 °C [-40 °F to 158 °F]
Mechanical life	up to 10 million; up to 5 million (wobble actuators)
Thermal current	1 A, 3 A, 5 A (depending upon model)
Rated insulation voltage (Ui)	250 V
Rated impulse withstand voltage (Uimp)	1.5 kV
Short circuit protection device (SCPD)	Quick blow fuse suitable for rated current of switch
Pollution degree	3
Min. actuation speed	0.003 m/s
Max. actuation speed	0.1 m/s
Max. actuation frequency	ac – 200 Hz; dc – 20 Hz
Shock	50 g – IEC 60068-2-27
Vibration	10 g – IEC 60068-2-6
Approvals	CE
Conforming to standards	EN 60947-5-1; AC-14 D300, DC-13 R300

*IP68 sealing submerged in one meter of water for 24 hours

Table 2. Electrical Ratings (in amperes)

Model example	Contacts	Rating
14CE_ _	Silver contacts	A
14CE_ _G	Gold contacts	B
14CE_ _Q, -AQ, -AQ1	Silver contacts	C with 4-pin connector

Rating code		Make	Break
A	240 Vac, ind.	1.2	0.2
	240 Vac, res.	5	5
	28 Vdc, res.	3	3
	28 Vdc, ind.	3	3
	5 A, 1/10 HP, 125 Vac or 250 Vac	–	–
B	5-25 mA	–	–
	5-50 Vdc	–	–
C	3 A, 125 Vac or 250 Vac	–	–

MICRO SWITCH Miniature Precision Limit Switches, 14CE Series

SWITCHING AND LEAD IDENTIFICATION

14CE

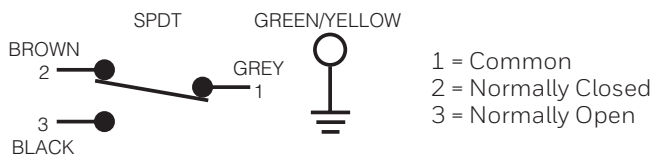

PINOUTS

Connector - (dc) (-Q)



Connector (ac) (-Q1)

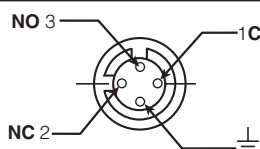

CONNECTOR VERSIONS

The 14CE Series is available with a 4-pin, M12 size connector in both bottom and side exit versions.

-Q, -Q2 Versions

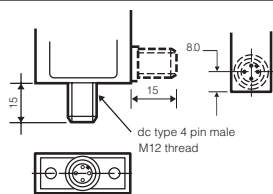

OPTION Q

Q1 Version

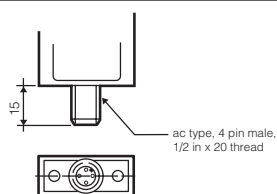

OPTION Q1

MOUNTING

MICRO SWITCH 14CE Series switches are mounted by using two M5 screws. The mounting holes are counter bored to keep the screw heads within the overall switch housing dimensions.

GANG MOUNT CAPABILITY

The housing on the 14CE Series has been designed to enable the user to build his own multiple plunger switch by gang mounting several switches. All pin plunger and roller plunger types are suitable for gang mounting. There is a 16 mm distance between the plungers. Both Series are very versatile that even a lever-type version could be added at the end of the row.

BOTTOM EXIT OR SIDE EXIT ORIENTATION

The CE Series has been designed with a pre-wired cable or connector fitted in the bottom of the switch housing. Other variations are available with a side-exit cable or connector.

GOLD CONTACT VERSIONS

For low energy applications (up to 30 Vdc, 1 A), gold contact versions of the 14CE switches can be supplied upon request.

MICRO SWITCH Miniature Precision Limit Switches, 14CE Series

GENERAL DIMENSIONS • ALL SWITCHES

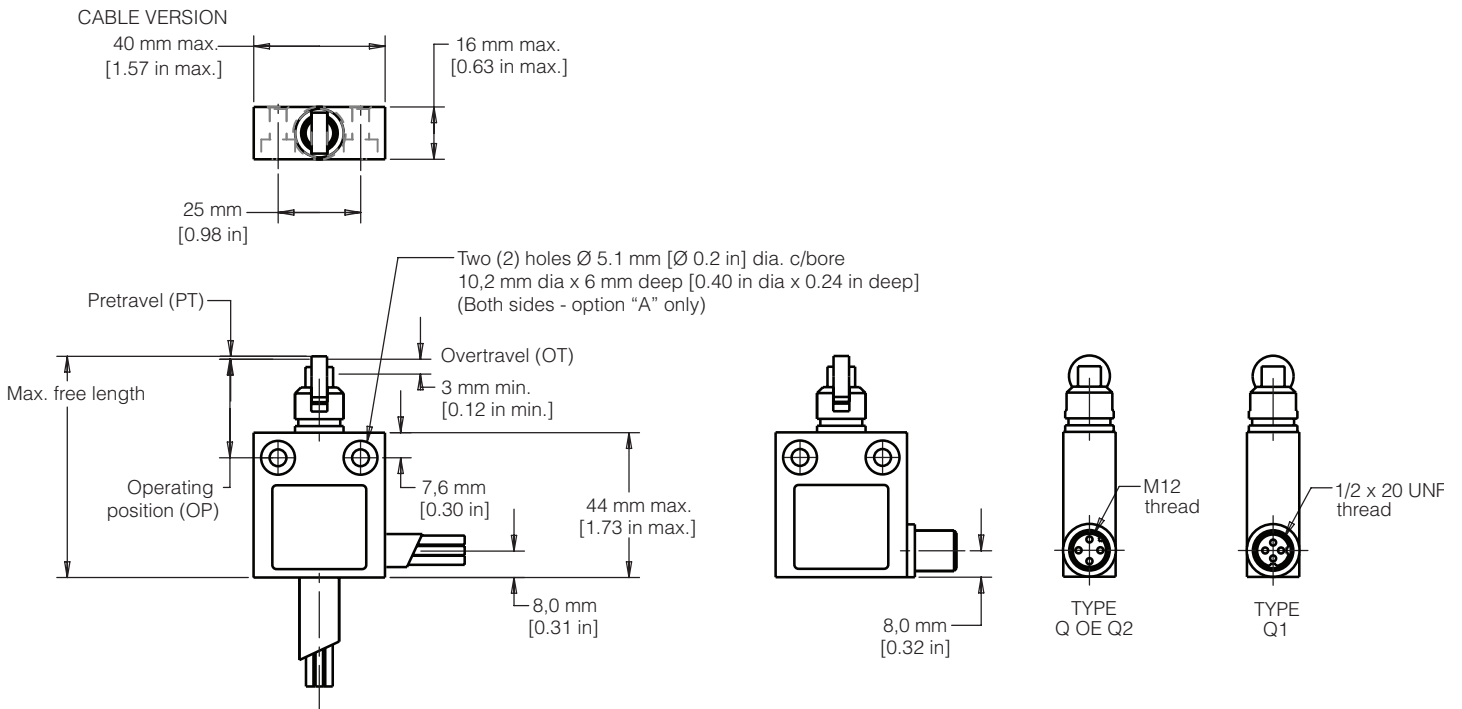

PRODUCT NOMENCLATURE

14CE	16	—	3		Connectors* (micro type)
Switch Type	Actuator Type		Cable Length*	Options ^{1,2}	
14CE Series Compact Precision Limit Switch	1 Top pin plunger	22 Manually oper. nylon button	1 1 meter	A Side entry	Q dc type single keyway 4-pin male, M12
	2 Top roller plunger, parallel	27 Top pin plunger, panel mount	2 2 meters	B Elongated mounting holes	Q1 ac type two keyways 4-pin male, 1/2-20
	3 Top roller plunger, perp.	28 Top roller plunger, parallel panel mount	3 3 meters	D Halogen-free cable	
	16 Front rotary	29 Top roller plunger, perp. panel mount	4 4 meters	G Gold contacts	
	18 Top pin plunger w/ boot seal	31 Top roller plunger, parallel boot seal	5 5 meters	H High temp., 150 °C	
	19 Top adjustable pin plunger	55 Top roller plunger, perp. boot seal		L Low temp., -40 °C switch and cable	
	20 Coil wobble	66 Top ball bearing plunger		L1 Low temp., -40 °C, cable not for flexing	
				P Top mounting	
			V Viton® seals/gasket (front rotary and booted sealed plungers only)		

NOTE: not all combinations of model codes are available. Please contact your Honeywell provider/representative for assistance.

¹More than one option may be permissible.

* Select "Cable Length" or "Connectors"

²OPTION K to be discontinued. Replaced with fluorocarbon diaphragm seal, standard switch.
²OPTION KV to be discontinued. Replaced with fluorocarbon diaphragm seal, standard switch.

Bottom exit is standard.

MICRO SWITCH Miniature Precision Limit Switches, 14CE Series

PRODUCT SPECIFICATIONS AND LISTINGS

Contact your Honeywell rep or distributor for additional listings

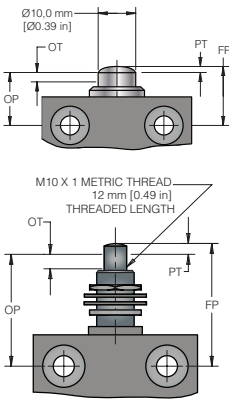
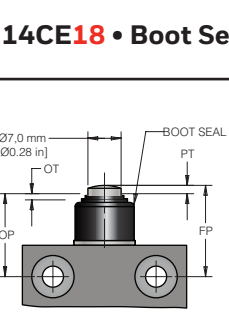
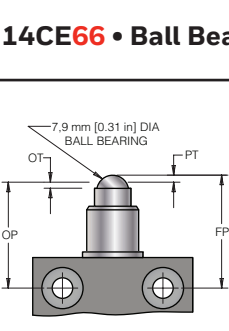
14CE1 • Pin Plunger 14CE27 • Pin Plunger Panel Mount	Con- tacts	Elec Rating	Cable Exit	Free Posi- tion (FP)	Operating Position (OP)	Options	Listing
 <p> Pretravel • 1,8 mm [0.071 in] Diff. travel • 0,1 mm [0.004 in] Overtravel • 3,0 mm [0.118 in] Oper. force • 11,8 N [2.65 lb] </p>	Silver GRY-BRN GRY-BLK GRY-BLK GRY-BRN	A B A C A	Bottom Bottom Side Bottom Bottom	17,5 mm [0.69 in] 17,5 mm [0.69 in] 17,5 mm [0.69 in] 17,5 mm [0.69 in] 31,1 mm [1.23 in]	15,7 mm [0.62 in] 15,7 mm [0.62 in] 15,7 mm [0.62 in] 15,7 mm [0.62 in] 29,3 mm [1.15 in]	– Gold-plated contacts Side exit cable dc-type connector Panel mount	14CE1-1 14CE1-1G 14CE1-1A 14CE1-Q 14CE27-1
	17,5 15,7 12,7 15,8						
 <p> Pretravel • 1,8 mm [0.071 in] Diff. travel • 0,1 mm [0.004 in] Overtravel • 3,0 mm [0.118 in] Oper. force • 22,5 N [5.06 lb] </p>	Silver GRY-BRN GRY-BLK GRY-BRN	A A C	Bottom Side Bottom	26,7 mm [1.05 in] 26,7 mm [1.05 in] 26,7 mm [1.05 in]	24,9 mm [0.98 in] 24,9 mm [0.98 in] 24,9 mm [0.98 in]	– Side exit cable dc-type connector	14CE18-1 14CE18-1A 14CE18-Q
	26,7 24,9 21,9 25						
 <p> Pretravel • 1,8 mm [0.071 in] Diff. travel • 0,1 mm [0.004 in] Overtravel • 3,0 mm [0.118 in] Oper. force • 11,8 N [2.65 lb] </p>	Silver GRY-BRN GRY-BLK GRY-BLK GRY-BRN	A A	Bottom Side	26,2 mm [1.03 in] 26,2 mm [1.03 in]	24,4 mm [0.96 in] 24,4 mm [0.96 in]	– Side exit cable	14CE66-1 14CE66-1A
	26,2 24,4 21,4 24,5						

MICRO SWITCH Miniature Precision Limit Switches, 14CE Series

14CE2 • Roller Plunger 14CE28 • Roller Plunger Panel Mount		Con-tacts	Elec Rating	Cable Exit	Free Position (FP)	Operating Position (OP)	Options	Listing
<p> Pretravel • 1,8 mm [0.071 in] Diff. travel • 0,1 mm [0.004 in] Overtravel • 3,0 mm [0.118 in] Oper. force • 11,8 N [2.65 lb] </p>		Silver	A	Bottom	30,3 mm [1.19 in]	28,5 mm [1.12 in]	-	14CE2-1
		Gold	B	Bottom	30,3 mm [1.19 in]	28,5 mm [1.12 in]	Gold-plated contacts	14CE2-1G
		Silver	C	Bottom	30,3 mm [1.19 in]	28,5 mm [1.12 in]	dc-type connector	14CE2-Q
		Silver	A	Side	30,3 mm [1.19 in]	28,5 mm [1.12 in]	Side exit cable	14CE2-1A
		Silver	A	Bottom	44,3 mm [1.75 in]	42,5 mm [1.67 in]	Panel mount, 2 m cable	14CE28-2
14CE31 • Boot Sealed Roller Plunger		Con-tacts	Elec Rating	Cable Exit	Free Position (FP)	Operating Position (OP)	Options	Listing
<p> Pretravel • 1,8 mm [0.071 in] Diff. travel • 0,1 mm [0.004 in] Overtravel • 3,0 mm [0.118 in] Oper. force • 17,5 N [3.93 lb] </p>		Silver	A	Bottom	36,2 mm [1.43 in]	34,4 mm [1.36 in]	-	14CE31-1
		Silver	A	Bottom	36,2 mm [1.43 in]	34,4 mm [1.36 in]	Fluorocarbon seals, 6 m cable	14CE31-6V
14CE3 • Cross Roller Plunger		Con-tacts	Elec Rating	Cable Exit	Free Position (FP)	Operating Position (OP)	Options	Listing
<p> Pretravel • 1,8 mm [0.071 in] Diff. travel • 0,1 mm [0.004 in] Overtravel • 3,0 mm [0.118 in] Oper. force • 11,8 N [2.65 lb] </p>		Silver	A	Bottom	30,3 mm [1.19 in]	28,5 mm [1.12 in]	-	14CE3-1
		Silver	A	Side	30,3 mm [1.19 in]	28,5 mm [1.12 in]	3 m of cable, side exit	14CE3-3A
		Silver	C	Bottom	30,3 mm [1.19 in]	28,5 mm [1.12 in]	dc-type connector	14CE3-Q

MICRO SWITCH Miniature Precision Limit Switches, 14CE Series



14CE55 • Boot Sealed Cross Roller Plunger	Con-tacts	Elec Rating	Cable Exit	Free Posi-tion (FP)	Operating Position (OP)	Options	Listing
<p>ROLLER Ø 12,4 mm x 4,7 mm Ø 0.48 in x 0.020 in</p> <p>BOOT SEAL</p> <p>OT</p> <p>PT</p> <p>OP</p> <p>FP</p> <p>36,2 34,4 31,4</p> <p>GRY-BRN GRY-BLK GRY-BLN GRY-BRN</p> <p>34,5</p> <p>Pretravel • 1,8 mm [0.071 in] Diff. travel • 0,1 mm [0.004 in] Overtravel • 3,0 mm [0.118 in] Oper. force • 17,5 N [3.93 lb]</p>	Silver	A	Bottom	36,2 mm [1.43 in]	34,4 mm [1.36 in]	3 meters of cable	14CE55-3
14CE16 • Side Rotary	Con-tacts	Elec Rating	Cable Exit	Free Posi-tion (FP)	Operating Position (OP)	Options	Listing
<p>Actuator shaft Ø1,22 mm [0.048 in]</p> <p>PT</p> <p>FP</p> <p>OT</p> <p>DT</p> <p>18,9 mm [0.74 in]</p> <p>0° 30° 70°</p> <p>GRY-BRN GRY-BLK GRY-BLN GRY-BRN</p> <p>27°</p> <p>Pretravel • 30° Diff. travel • 3° Overtravel • 40° Oper. force • 0,34 Nm [3 in-lb]</p>	Silver	A	Bottom	0°	30°	-	14CE16-1¹
	Gold	B	Bottom	0°	30°	Gold-plated contacts, 3 meters of cable	14CE16-3G¹
	Silver	C	Bottom	0°	30°	dc-type connector	14CE16-Q¹
14CE20 • Random Motion Wire Actuator	Con-tacts	Elec Rating	Cable Exit	Free Posi-tion (FP)	Operating Position (OP)	Options	Listing
<p>OP</p> <p>ALL DIRECTIONS EXCEPT DIRECT PULL</p> <p>Ø1,8 mm [Ø0.07 in]</p> <p>335,0 mm max. [13,98 mm max.]</p> <p>0 28 max.</p> <p>GRY-BRN GRY-BLK GRY-BLN GRY-BRN</p> <p>Oper. position • 28 mm [1.10 in] max. Oper. force • 0,55 N [0.12 lb] max.</p>	Silver	A	Bottom	-	28 mm [1.10 in] max.	-	14CE20-1

¹ Switch operates on clockwise and counterclockwise rotation of lever shaft

Note: Most part numbers are shown with 1 meter of cable. The -X indicates the number of meters of cable provided: 2-meters, 3-meters, 4-meters, and 5-meters. Custom lengths are also available.

MICRO SWITCH Miniature Precision Limit Switches, 14CE Series

Table 3. Levers for Use with 14CE Side Rotary Switches

	Catalog Listing	Roller Material	Roller Dia. mm [in]	Roller Width mm [in]
Fixed length lever; 38,1 mm [1.5 in] radius				
	GLZ51A	Nylon	19,0 [0.75]	6,35 [0.25]
	GLZ51B	Steel	19,0 [0.75]	6,35 [0.25]
	GLZ51C	Nylon	25,4 [1.00]	12,7 [0.50]
	GLZ51E	Bronze	19,0 [0.75]	6,35 [0.25]
	GLZ51T	SST	19,0 [0.75]	9,5 [0.38]
Fixed length offset lever; 38,1 mm [1.5 in] radius				
	GLZ55A	Nylon	19,0 [0.75]	6,35 [0.25]
	GLZ55B	Steel	19,0 [0.75]	6,35 [0.25]
	GLZ55E	Bronze	19,0 [0.75]	6,35 [0.25]
Fixed length offset lever; 38,1 mm [1.5 in] radius				
	GLZ52A	Nylon	19,0 [0.75]	6,35 [0.25]
	GLZ52B	Steel	19,0 [0.75]	6,35 [0.25]

ADDITIONAL MATERIALS

- Product installation instructions
- Product range guide
- Product nomenclature tree
- Product application-specific information
 - Limit and enclosed switches application information
 - Limit and enclosed switches operating characteristics
 - Limit and enclosed switches reference standards
 - Limit and enclosed switches typical applications
 - Product flyer: CE Family Miniature Limit Switches

WARNING **PERSONAL INJURY**

DO NOT USE these products as safety or emergency stop devices or in any other application where failure of the product could result in personal injury.

Failure to comply with these instructions could result in death or serious injury.

WARNING **MISUSE OF DOCUMENTATION**

- The information presented in this product sheet is for reference only. Do not use this document as a product installation guide.
- Complete installation, operation, and maintenance information is provided in the instructions supplied with each product.

Failure to comply with these instructions could result in death or serious injury.

For more information

Honeywell Sensing and Internet of Things services its customers through a worldwide network of sales offices and distributors. For application assistance, current specifications, pricing or the nearest Authorized Distributor, visit sensing.honeywell.com or call:

Asia Pacific	+65 6355-2828
Europe	+44 1698 481481
USA/Canada	+1-800-537-6945

Honeywell Sensing and Internet of Things

9680 Old Bailes Road
Fort Mill, SC 29707
www.honeywell.com

Warranty/Remedy

Honeywell warrants goods of its manufacture as being free of defective materials and faulty workmanship during the applicable warranty period. Honeywell's standard product warranty applies unless agreed to otherwise by Honeywell in writing; please refer to your order acknowledgment or consult your local sales office for specific warranty details. If warranted goods are returned to Honeywell during the period of coverage, Honeywell will repair or replace, at its option, without charge those items that Honeywell, in its sole discretion, finds defective. **The foregoing is buyer's sole remedy and is in lieu of all other warranties, expressed or implied, including those of merchantability and fitness for a particular purpose. In no event shall Honeywell be liable for consequential, special, or indirect damages.**

While Honeywell may provide application assistance personally, through our literature and the Honeywell web site, it is buyer's sole responsibility to determine the suitability of the product in the application.

Specifications may change without notice. The information we supply is believed to be accurate and reliable as of this writing. However, Honeywell assumes no responsibility for its use.

Viton® is a registered trademark of DuPont Performance Elastomers L.L.C.

002387-4-EN | 4 | 03/19
© 2019 Honeywell International Inc. All rights reserved.

Honeywell