

MICRO SWITCH Safety Limit Switches for Hazardous Locations

GSX Series

004764

Issue 3

Datasheet



DESCRIPTION

When the application requires a safety limit switch for hazardous environmental areas which potentially include explosive gas, dust, or fibers, Honeywell offers GSX Series safety limit switches that provide a preferred solution for the hazardous environments while monitoring gate positions. The GSX Series of safety limit switches incorporate the same internal contact block as the Global Safety Limit Switch (GSS Series). All normally closed contacts are positive opening . A wide variety of contact blocks and actuator head combinations solve many applications.

The GSX Series safety limit switches are certified for weather-sealed indoor and outdoor environments and are also certified for continuous or intermittent use in hazardous/explosive environments through a number of different independent agencies for global applications.

DIFFERENTIATION

- Up to four electrically independent contacts (Zb) per limit switch for monitoring of gates
- Designed and agency evaluated for safety functions up to and including a safety integrity level 3 (SIL3)
- Safety industrial limit switch globally certified for hazardous/explosive environments and environmentally sealed
- Gold-plated contacts available for integrity of switch contacts in hostile environments with low energy applications
- Side rotary actuator head incorporates dual bearing design for increased mechanical life

FEATURES

- Safety limit switch typically suitable for global hazardous/explosive environments with cULus, CE, IEC Ex, INMETRO, and KOSHA certifications
- Up to four normally closed (NC) contacts per switch or a combination of NC and normally open (NO) contacts per limit switch
- NC contacts are positive opening  for positive mode monitoring of gates
- NO contacts available for signal circuits or negative mode monitoring of gates
- Red switch body for easy safety recognition
- Choice of actuator head types: top pin plunger, top roller plunger, top roller lever, or side rotary
- Different threaded conduit options for global applications

POTENTIAL APPLICATIONS

Access panels, gates, guards, or doors on machinery for:

- Grain elevators and grain processing facilities
- Hydrocarbon and ethanol facilities
- Chemical processing
- Paint booths
- Pharmaceutical processing
- Power generation plants
- Pulp and paper processing

PORTFOLIO

Honeywell offers other safety "limit" switches which include the non-contact safety switches (FF Series) and cable/rope-pull safety switches (1CPS & 2 CPS Series). Honeywell safety interlocking switches include the metal-body EN50041 GK Series, metal-body solenoid (trapped key) GKL/R Series, the plastic-body EN50047 GKE Series, miniature plastic-body GKM Series, and plastic-body GKN Series.

For other hazardous location applications, Honeywell offers a wide range of limit switches in different size packages and hazardous environments. These limit switches include the BX/BX2 Series, CX Series, EX Series, LSX Series, GXS Series, and 14CE100 Series.

MICRO SWITCH Safety Limit Switches, GSX Series

Table 1. Specifications

Characteristic	Parameter
Description	GSX Series safety limit switches for hazardous areas (explosive environments)
Agency certifications	See Table 3
Housing material	Electrostatic epoxy coated aluminum body and zinc actuator heads
Actuator heads	Side rotary with various lever options, top pin plunger, top roller plunger, top roller lever
Conduit/electrical connection	0.5-14 NPT, 20 mm, PG 13,5, G1/2 (PF1/2)
Contact/switch options and types ¹	1NC/1NO snap action, slow action BBM, or slow action MBB 2NC slow action 2NO slow action 2NC/2NO snap action, slow action BBM 2NC/1NO slow action BBM 3NC/1NO slow action BBM 4NC slow action
Contact design	Double break, electrically separated (Zb); 2NC/2NO snap action, each pole requires same polarity (Za)
Contact material	Silver alloy (standard), gold-plated (optional for low energy applications)
Utilization category	Snap action contacts: AC-15, A600; DC-13, Q300 Slow action contacts ³ : AC-15, A300; DC-13, Q300
Rated operational voltage (Ue)	120 Vac, 240 Vac, 600 Vac, 250 Vdc
Rated operational current (Ie)	6 A, 3 A, 1.2 A, 0.27 A
Thermal current (Ith)	10 A
Rated insulation voltage (Ui)	300 V, 600 V
Rated impulse withstand voltage (Uimp)	2500 V
Short circuit protection device (SCPD)	Class J fuse (10 A/600 V)
Pollution degree	3
Environmental sealing	IP67; NEMA 1, 3, 4, 12, and 13
Operating temperature	-40°C to 70°C [-40°F to 158°F]
Shock	50 g per IEC 60068-2-27
Vibration	10 g per IEC 60068-2-6
MCTF (Mechanical life)	>1,000,000 cycles with single-sided confidence limit of 100%
MCTF (Electrical life)	>25,000 cycles with single-sided confidence limit of 100%
SIL capability ²	SIL3 capable with HFT =1, SIL2 capable with HFT =0 with reference to IEC61508-2:2010
Proof test interval	1 year

1. All normally closed contacts are positive opening .

2. HFT (Hardware Fault Tolerance).

3. Slow action 1NC/1NO contacts: AC-15, A600; DC-13, Q300

Table 2. Electrical Specifications

Designation and Utilization Category		Rated Operational Current Ie (A) at Rated Operational Voltage Ue (V)						
		24 V	120 V	240 V	380 V	480 V	500 V	600 V
AC-15	A300	–	6 A	3 A	–	–	–	–
AC-15	A600	–	6 A	3 A	1.9 A	1.5 A	1.4 A	1.2 A
DC-13	Q300	2.8 A	0.55 A	0.27 A	–	–	–	–
Gold-plated contacts		1 V 10 µA min.; 50 V 100 mA max.						

MICRO SWITCH Safety Limit Switches, GSX Series

Table 3. Agency Certifications

Europe ATEX	Europe CE	Canada cUL	USA UL	International IEC Ex	Asian Certificate Korea	South America, Brazil	Safety Integrity Level
							-
Sira 08AT-EX1073X	DOC A413	E61730	E61730	IEC Ex SIR 08.0021X	KOSHA 2013-BO-0400	INMETRO TUV 14.0555X	SIL3 SIRA FSP11002/02
North America		Class I (Flammable gas) Groups B, C, and D (Div 1 and 2) Class II (Combustible dust) Groups E, F, and G (Div 1 and 2) Class III (Combustible fibers and flyings) Div 1 and 2					
ATEX and IEC Ex		II 2 GD, Ex d IIC T6 Gb Ex t IIIC IP6X T85°C Db (Tamb -40°C to 70°C)					

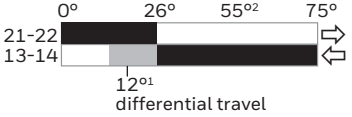
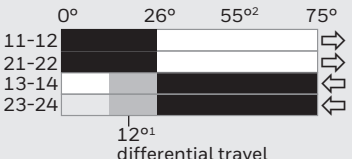
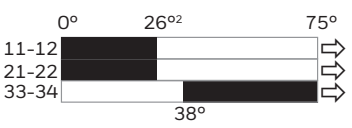
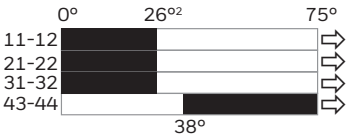

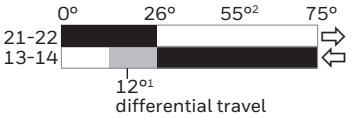

Figure 1. Product Nomenclature

GSX	A	01	A	1	A	-
Switch Type	Conduit Connection	Circuitry	Head Style	Actuator Style	Lever Roller	Modifications/ Specials
GSX Series Hazardous Area Safety Switch	A 1/2 in NPT	01 Snap action, 1NC/1NO	A Side rotary; momentary	1 Fixed length roller	A 19,0 mm x 6,35 mm [0.75 in x 0.25 in] nylon roller	1 Clockwise rotation
	B PG 13.5	03 Slow action, 1NC/1 NO, BBM	B Top pin plunger	3 Yoke roller	C 24,4 mm x 12,7 mm [1.0 in x 0.5 in] nylon roller	2 Counter-clockwise rotation
	C 20 mm	04 Slow action, 1NC/1 NO, MBB	C Top roller plunger	5 Offset roller	D 38,1 mm x 6,35 mm [1.5 in x 0.25 in] nylon roller	3 Head assembled with actuator to right side
	D G 1/2 (PF 1/2)	05 Slow action, 2NO	D Top roller lever		E 19,0 mm x 6,35 mm [0.75 in x 0.25 in] bronze roller	4 Head assembled with actuator to left side
		06 Slow action, 2NC			W 40 mm x 12,7 mm [1.5 in x 0.5 in] bronze roller	5 Head assembled with actuator to mounting surface
		07 Snap action, 1NC/1NO, gold contacts			Y 50,9 mm x 12,7 mm [2.0 in x 0.5 in] rubber roller	6 Roller perpendicular to mounting surface
		20 Snap action, 2NC/2NO				
		22 Snap action, 2NC/2NO, gold contacts				
		33 Slow action, 1NC/1NO, BBM, gold contacts				
		34 Slow action, 1NC/1NO, MBB, gold contacts				
		35 Slow action, 2NO, gold contacts				
		36 Slow action, 2NC, gold contacts				
		40 Slow action, 4NC				
		41 Slow action, 4NC, gold contacts				
		42 Slow action, 2NC/1NO, BBM				
		43 Slow action, 2NC/1NO, BBM, gold contacts				
		44 Slow action, 2NC/2NO, BBM				
	45 Slow action, 2NC/2NO, BBM, gold contacts					
	46 Slow action, 3NC/1NO, BBM					
	47 Slow action, 3NC/1NO, BBM, gold contacts					

Note: Not all combinations available. Please contact Honeywell for more information or assistance.

MICRO SWITCH Safety Limit Switches, GSX Series

Table 4. Order Guide

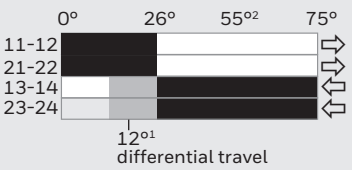
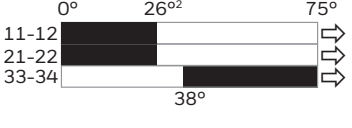
	Catalog Listing	Conduit ¹	Head and Lever Type	Contacts	Contact Material	Oper. Force or Torque (max.)	Bar Chart degrees or mm ■ Contact Closed □ Contact Open ■ Contact Closed, Differential
	GSXA01A	0.5-14 NPT	Side rotary, no lever furnished, order separately	1NC/1NO snap action	Silver alloy	0,3 Nm [2.6 in lb]	
	GSXC22A	20 mm	Side rotary, no lever furnished, order separately	2NC/2NO snap action	Gold-plated	0,3 Nm [2.6 in lb]	
	GSXA42A	0.5-14 NPT	Side rotary, no lever furnished, order separately	2NC/1NO slow action, BBM	Silver alloy	0,3 Nm [2.6 in lb]	
	GSXC42A	20 mm					
	GSXA46A	0.5-14 NPT	Side rotary, no lever furnished, order separately	3NC/1NO slow action, BBM	Silver alloy	0,3 Nm [2.6 in lb]	
	GSXC46A	20 mm					
	GSXA01A1A	0.5-14 NPT	Side rotary with 38,1 mm [1.5 in] lever with nylon roller	1NC/1NO snap action	Silver alloy	0,3 Nm [2.6 in lb]	
	GSXC01A1C	20 mm	Side rotary with 38,1 mm [1.5 in] lever with nylon roller ³	1NC/1NO snap action	Silver alloy	0,3 Nm [2.6 in lb]	
	GSXC01A1E	20 mm	Side rotary with 38,1 mm [1.5 in] lever with copper alloy roller	1NC/1NO snap action	Silver alloy	0,3 Nm [2.6 in lb]	
	GSXA07A1A	0.5-14 NPT	Side rotary with 38,1 mm [1.5 in] lever with nylon roller	1NC/1NO snap action	Gold-plated	0,3 Nm [2.6 in lb]	
	GSXC07A1E	20 mm	Side rotary with 38,1 mm [1.5 in] lever with copper alloy roller	1NC/1NO snap action	Gold-plated	0,3 Nm [2.6 in lb]	
	GSXA20A1A	0.5-14 NPT	Side rotary with 38,1 mm [1.5 in] lever with nylon roller	2NC/2NO snap action	Silver alloy	0,3 Nm [2.6 in lb]	
	GSXA22A1A	0.5-14 NPT	Side rotary with 38,1 mm [1.5 in] lever with nylon roller	2NC/2NO snap action	Gold-plated	0,3 Nm [2.6 in lb]	
	GSXA42A1E	0.5-14 NPT	Side rotary with 38,1 mm [1.5 in] lever with copper alloy roller	2NC/1NO slow action, BBM	Silver alloy	0,3 Nm [2.6 in lb]	
	GSXC42A1E	20 mm					
GSXA43A1E	0.5-14 NPT	Side rotary with 38,1 mm [1.5 in] lever with copper alloy roller	2NC/1NO slow action, BBM	Gold-plated	0,3 Nm [2.6 in lb]		



¹ Other conduit options are available, reference Product Nomenclature (Figure 1) on page 3.

² Positive opening occurs.

³ Nylon roller (Ø19 x 6,35) replaced with nylon roller (Ø25 x 12,7).

MICRO SWITCH Safety Limit Switches, GSX Series

Table 4. Order Guide, continued

	Catalog Listing	Conduit ¹	Head and Lever Type	Contacts	Contact Material	Oper. Force or Torque (max.)	Bar Chart degrees or mm ■ Contact Closed □ Contact Open ■ Contact Closed, Differential
	GSXA46A1E	0.5-14 NPT	Side rotary with 38,1 mm [1.5 in] lever with copper alloy roller	3NC/1NO slow action, BBM	Silver alloy	0,3 Nm [2.6 in lb]	
	GSXC46A1E	20 mm					
	GSXA03B	0.5-14 NPT	Top pin plunger	1NC/1NO slow action, BBM	Silver alloy	16,0 N [3.6 lb]	
	GSXA42B	0.5-14 NPT	Top pin plunger	2NC/1NO slow action, BBM	Silver alloy	16,0 N [3.6 lb]	
	GSXC42B	20 mm					
	GSXA44B	0.5-14 NPT	Top pin plunger	2NC/2NO slow action, BBM	Silver alloy	16,0 N [3.6 lb]	
	GSXA46B	0.5-14 NPT	Top pin plunger	3NC/1NO slow action, BBM	Silver alloy	16,0 N [3.6 lb]	
	GSXC46B	20 mm					
	GSXA42C	0.5-14 NPT	Top roller plunger	2NC/1NO slow action, BBM	Silver alloy	16,0 N [3.6 lb]	
	GSXC42C	20 mm					
	GSXA46C	0.5-14 NPT	Top roller plunger	3NC/1NO slow action, BBM	Silver alloy	16,0 N [3.6 lb]	
	GSXA46C	20 mm					
	GSXA42D	0.5-14 NPT	Top roller lever	2NC/1NO slow action, BBM	Silver alloy	9,5 N [2.1 lb]	
	GSXC42D	20 mm					
	GSXA46D	0.5-14 NPT	Top roller lever	3NC/1NO slow action, BBM	Silver alloy	9,5 N [2.1 lb]	
	GSXC46D	20 mm					

¹ Other conduit options are available, reference Product Nomenclature (Figure 1) on page 3.

² Positive opening occurs

MICRO SWITCH Safety Limit Switches, GSX Series

Figure 2. Mounting Dimensions mm [in]

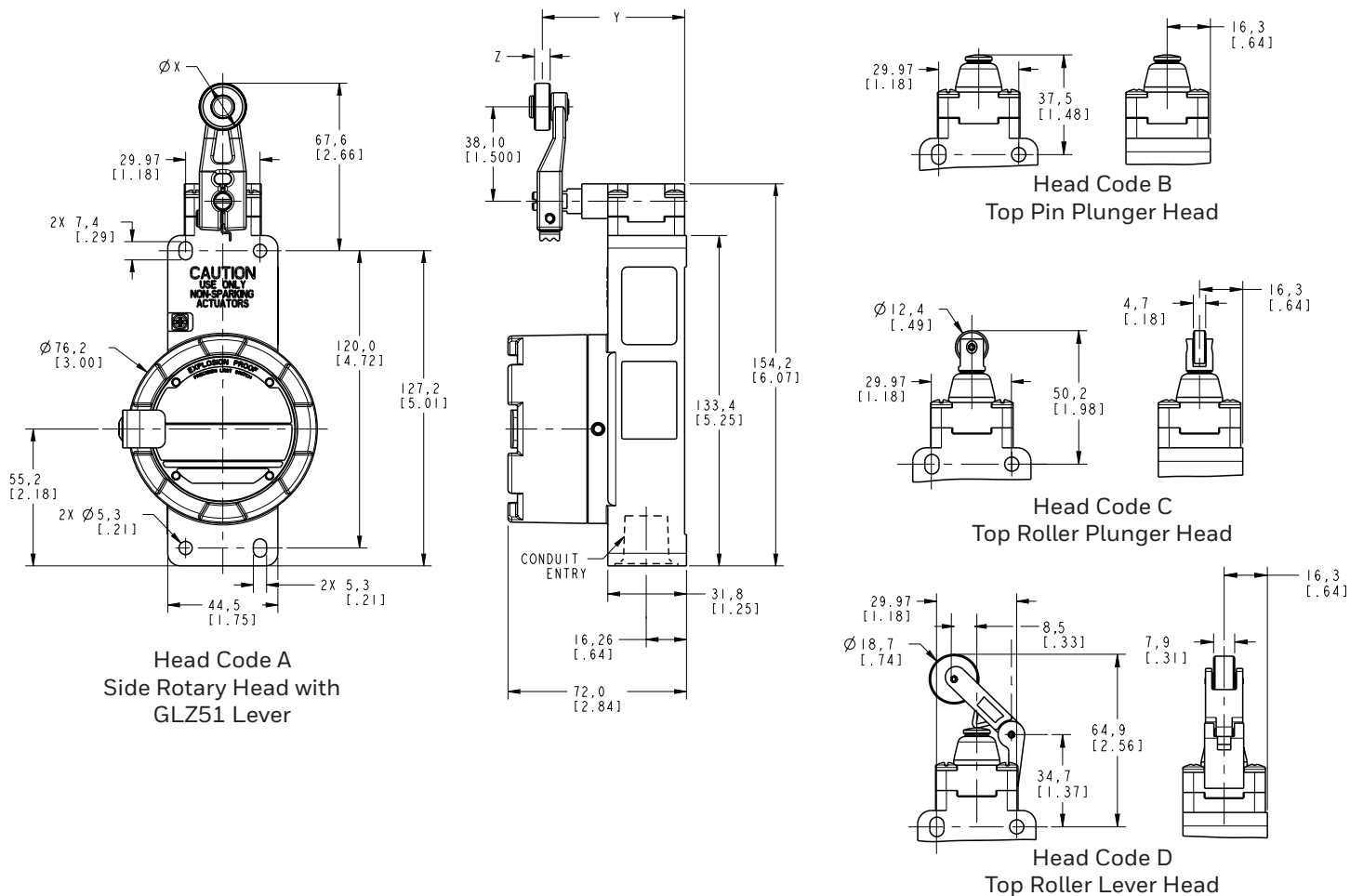

Table 5. Mounting Dimensions for Head Code A (Side Rotary) and Levers with Rollers

Actuator Code	Replace-ment Lever	Roller Material	“X” Dim. Ø	“Y” Dim.	“Z” Dim Width
1A	GLZ51A	Nylon	19,0 mm [0.75 in]	55,9 mm [2.20 in]	6,4 mm [0.25 in]
1C	–	Nylon	25,4 mm [1.00 in]	59,2 mm [2.33 in]	12,7 mm [0.50 in]
1D	GLZ51D	Nylon	38,1 mm [1.50 in]	55,9 mm [2.20 in]	6,4 mm [0.25 in]
1E	GLZ51E	Bronze	19,0 mm [0.75 in]	55,9 mm [2.20 in]	6,4 mm [0.25 in]
1Y	GLZ51Y	Rubber	50,0 mm [1.97 in]	57,7 mm [2.27 in]	9,9 mm [0.39 in]
3A	GLZ53A	Nylon	19,0 mm [0.75 in]	55,9 mm [2.20 in]	6,4 mm [0.25 in]
3E	GLZ53E	Bronze	19,0 mm [0.75 in]	55,9 mm [2.20 in]	6,4 mm [0.25 in]
5A	GLZ55A	Nylon	50,0 mm [1.97 in]	83,2 mm [3.28 in]	6,4 mm [0.25 in]
5E	GLZ55E	Bronze	19,0 mm [0.75 in]	83,2 mm [3.28 in]	6,4 mm [0.25 in]

ADDITIONAL MATERIALS

The following associated literature is available at sensing.honeywell.com:

- Product range guide
- Installation instructions
- Application note

Find out more

Honeywell serves its customers through a worldwide network of sales offices and distributors.

For application assistance, current specifications, pricing or name of the nearest Authorized Distributor, contact your local sales office.

To learn more about Honeywell's sensing and switching products, call **+1-815-235-6847** or **1-800-537-6945**,

visit **sensing.honeywell.com**, or e-mail inquiries to **info.sc@honeywell.com**

Honeywell Sensing and Internet of Things

9680 Old Bailes Road
Fort Mill, SC 29707
honeywell.com

WARNING **IMPROPER INSTALLATION**

- Consult with local safety agencies and their requirements when designing a machine-control link, interface and all control elements that affect safety.
- Strictly adhere to all installation instructions.

Failure to comply with these instructions could result in death or serious injury.

WARNING **MISUSE OF DOCUMENTATION**

- The information presented in this product sheet is for reference only. Do not use this document as a product installation guide.
- Complete installation, operation, and maintenance information is provided in the instructions supplied with each product.

Failure to comply with these instructions could result in death or serious injury.

Warranty/Remedy

Honeywell warrants goods of its manufacture as being free of defective materials and faulty workmanship during the applicable warranty period. Honeywell's standard product warranty applies unless agreed to otherwise by Honeywell in writing; please refer to your order acknowledgment or consult your local sales office for specific warranty details. If warranted goods are returned to Honeywell during the period of coverage, Honeywell will repair or replace, at its option, without charge those items that Honeywell, in its sole discretion, finds defective. **The foregoing is buyer's sole remedy and is in lieu of all other warranties, expressed or implied, including those of merchantability and fitness for a particular purpose. In no event shall Honeywell be liable for consequential, special, or indirect damages.**

While Honeywell may provide application assistance personally, through our literature and the Honeywell web site, it is buyer's sole responsibility to determine the suitability of the product in the application.

Specifications may change without notice. The information we supply is believed to be accurate and reliable as of this writing. However, Honeywell assumes no responsibility for its use.

Honeywell