

Airflow Sensors
AWM9000 Series

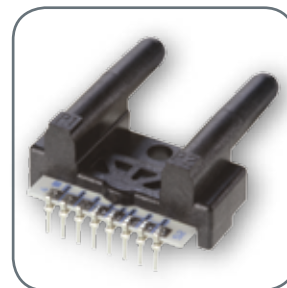

Airflow Sensors

AWM90000 Series microbridge mass airflow sensors are available in two versions, mass flow and differential pressure.

The AWM92100V has a flow range of ± 200 SCCM with a pressure drop of only 0.49 mbar | 49 Pa | 0.007 psi, typically. The AWM92200V is a differential pressure version that has a range of ± 2 inH₂O.

The AWM90000 Series sensors have a 1 ms response time, operate with a supply voltage from 8.0 Vdc to 15.0 Vdc, while consuming only 50 mW of power. The compact plastic package will withstand a maximum overpressure of 1720 mbar | 72 kPa | 25 psi without compromising performance. The sensor is well suited for use in portable devices and battery-powered applications.

The AWM90000 Series provides customers with a combination of time-proven reliability, repeatable flow sensing, and the ability to customize the sensor functions to meet their specific application needs.

Key Features and Benefits

- **Bi-directional sensing capability:** Allows use in applications where bidirectional flow is present
- **Highly stable null and full-scale:** Does not require recalibration in most applications
- **Low pressure drop:** Provides improved system performance
- **Compact package design:** Occupies less space in the customer's enclosure, potentially reducing production costs; enclosure size may also be reduced for easier fit into space-constrained applications
- **Low hysteresis and repeatability errors (less than 0.35% of reading):** Provides improved overall system accuracy
- **Fast response time (1 ms typical):** Captures full flow event
- **Low power consumption (50 mW max.):** Allows for use in portable devices and battery-powered applications

Potential Applications

MEDICAL

- Continuous Positive Airway Pressure (CPAP) equipment
- Sleep apnea monitors
- Oxygen conservers
- Oxygen concentrators
- Nebulizers
- Spirometers

INDUSTRIAL

- Variable Air Volume (VAV) damper control
- Clogged filter detection
- Fuel to air ratio sensing
- Leak detection equipment

HIGHLY STABLE • LOW PRESSURE DROP • FAST RESPONSE TIME

Airflow Sensors, AWM90000 Series

Table 1. Specifications

Characteristic	Parameter	
	AWM92100V	AWM92200V
		
Type	mass flow	differential
Flow range	±200 SCCM	—
Pressure range	—	±5 mbar ± 500 Pa ±2.0 inH ₂ O
Excitation voltage ³	8.0 Vdc min./10 Vdc ±0.01 Vdc typ./15 Vdc max.	
Power consumption	50 mW max.	
Calibration gas	air	
Null voltage shift ¹ :		
Null voltage (25 °C [77 °F])	0 mV ±15 mV	0 mV ±15 mV
Null output shift:		
-25 °C to 85 °C [-13 °F to 185 °F]	±2 mV typ.	—
-20 °C to 80 °C [-4 °F to 176 °F]	—	±1 mV max.
Full scale output shift ² :		
-25 °C to -25 °C [-13 °F to 77 °F]	-3.0 %FSS typ.	25 %reading max.
25 °C to 85 °C [77 °F to 185 °F]	±1.0 %FSS typ.	30 %reading max.
Full scale output	77 mV ±32 mV	45 mV ±25 mV
Ratiometricity error ³	±0.30 %reading typ.	
Repeatability and hysteresis ⁴	±0.35 %FSS typ.	±0.1 %reading typ.
Response time	1 ms typ.	3 ms typ.
Pressure drop at full scale	0.49 mbar 49 Pa 0.007 psi, typ.	—
Overpressure	1720 mbar 172 kPa 25 psi max.	
Temperature range:		
operating	-25 °C to 85 °C [-13 °F to 185 °F]	-25 °C to 80 °C [-13 °F to 176 °F]
storage	-40 °C to 90 °C [-40 °F to 194 °F]	-40 °C to 90 °C [-40 °F to 194 °F]
Vibration	20 g, 10 Hz to 2000 Hz	
Shock	100 g, 6 ms	
Weight	5,6 g [0.20 oz]	

¹Assumes low TCR bridge resistance used (pins 2 and 8).

²Requires recommended RC value of 1 kOhm to be used (pins 3 though 7) and typical heater control circuit. Maximum current RH.

³Output voltage is ratiometric to supply voltage.

⁴Repeatability and hysteresis tolerances reflect inherent inaccuracies of the measurement equipment.

Airflow Sensors, AWM90000 Series

Table 2. AWM92100V Flow Specifications

Flow (SCCM)	Tolerance, min. (mV)	Nominal, typ. (Vdc)	Tolerance, typ. (mV)	Pressure Drop		
				(mbar)	(Pa)	(inH ₂ O)
200	45	77	109	0.148	14.775	0.0593
150	45	68	109	0.103	10.271	0.0412
100	45	56	109	0.063	6.299	0.0253
50	45	36	109	0.028	2.814	0.0113
0	45	0	109	0.000	0.000	0.0000
-50	45	-37	109	-0.028	-2.775	-0.0111
-100	45	-57	109	-0.063	-6.293	-0.0253
-150	45	-69	109	-0.103	-10.271	-0.0412
-200	45	-78	109	-0.148	-14.834	-0.0596

Table 3. AWM92200V Differential Pressure Specifications

Flow (inH ₂ O)	Tolerance, min. (mV)	Nominal, typ. (mV)	Tolerance, max. (mV)
2.0	22	38	77
1.5	18	32	66
1.0	12	23	49
0.5	7	12	29
0.0	-20	0	20
-0.5	-7	-12	-30
-1.0	-12	-23	-51
-1.5	-18	-32	-68
-2.0	-22	-39	-79

LAMINAR FLOW

Due to the fast response time of the sensor, the specifications in this datasheet were generated using laminar flow. Airflow instability or “turbulence” present in the airstream will result in an increase in measurement uncertainty. Turbulent flow may be corrected by either of the following two methods:

- Straightening the airflow by using flow laminarizing.
- Slowing the response of the sensor by using a simple RC time constant on the output of the sensor. (This will slow down the sensor response time.)

The values needed depend on the amount of turbulence present in the application. A technique for laminarizing the flow includes adding the following laminar flow elements to the flow stream:

- Hex-shaped honeycombs
- Foam
- Screen materials
- Constrictors (frits)

Unfortunately, the greater the efficiency of the laminarizer, the greater the increase in pressure drop in order to establish a given flow rate. Plastic honeycomb material probably gives the most improvement for the least pressure drop.

Ensure sharp radii are avoided in any test fixture.

Airflow Sensors, AWM90000 Series

Figure 1. Performance Characteristics (at 10.0 ±0.01 Vdc at 25 °C [77 °F])

AWM92100V Typical Output Voltage vs Flow

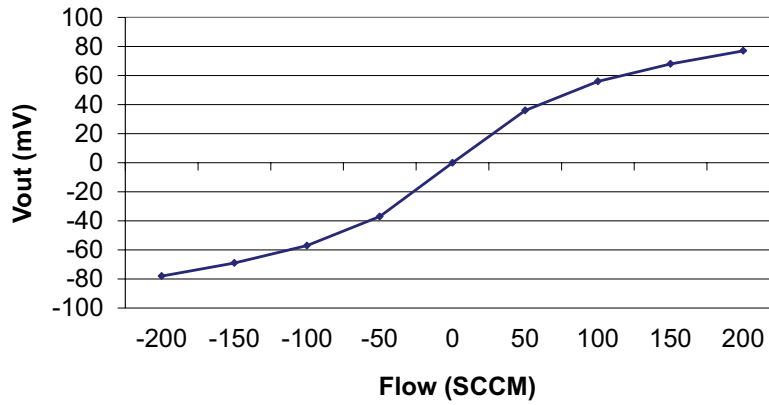

AWM92200V Typical Output Voltage vs Pressure

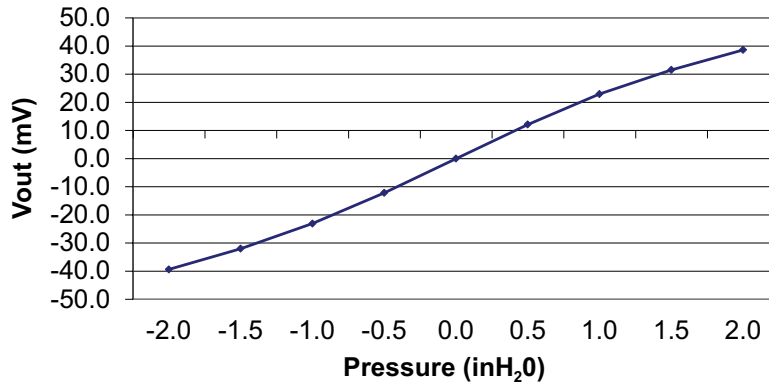
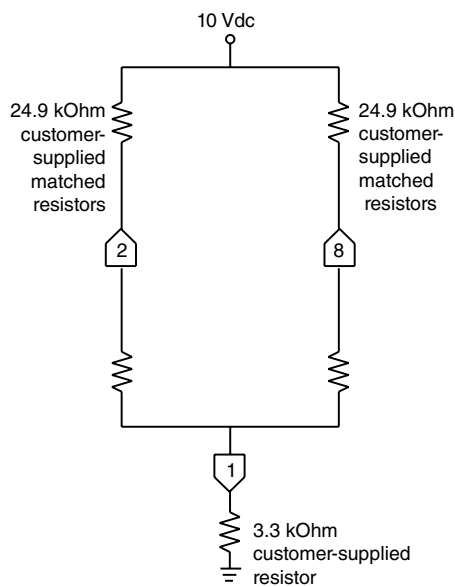

Figure 2. Wiring Diagrams

Sensor bridge circuit

The customer-supplied resistors affect null output voltage; output is measured differentially from Pin 8 to Pin 2.



Used with heater control circuit

The customer-supplied resistor affects temperature compensation and span voltage.

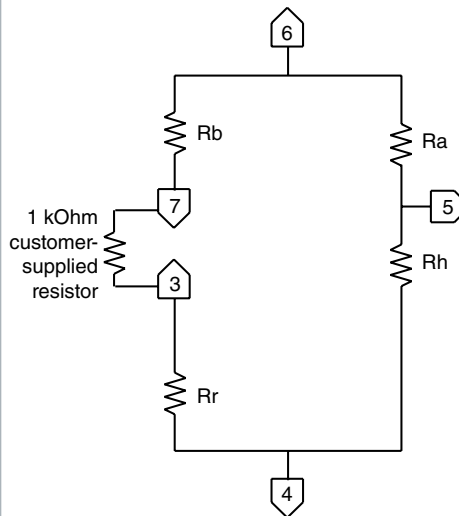

Suggested heater control circuitry

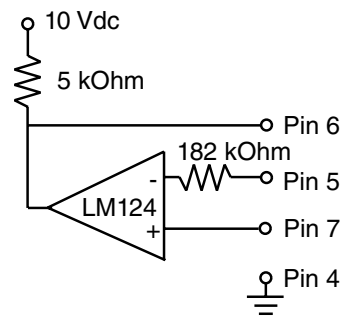

Airflow Sensors, AWM90000 Series

Figure 3. Mounting Dimensions (For reference only: mm/[in.])

AWM92100V, AWM92200V

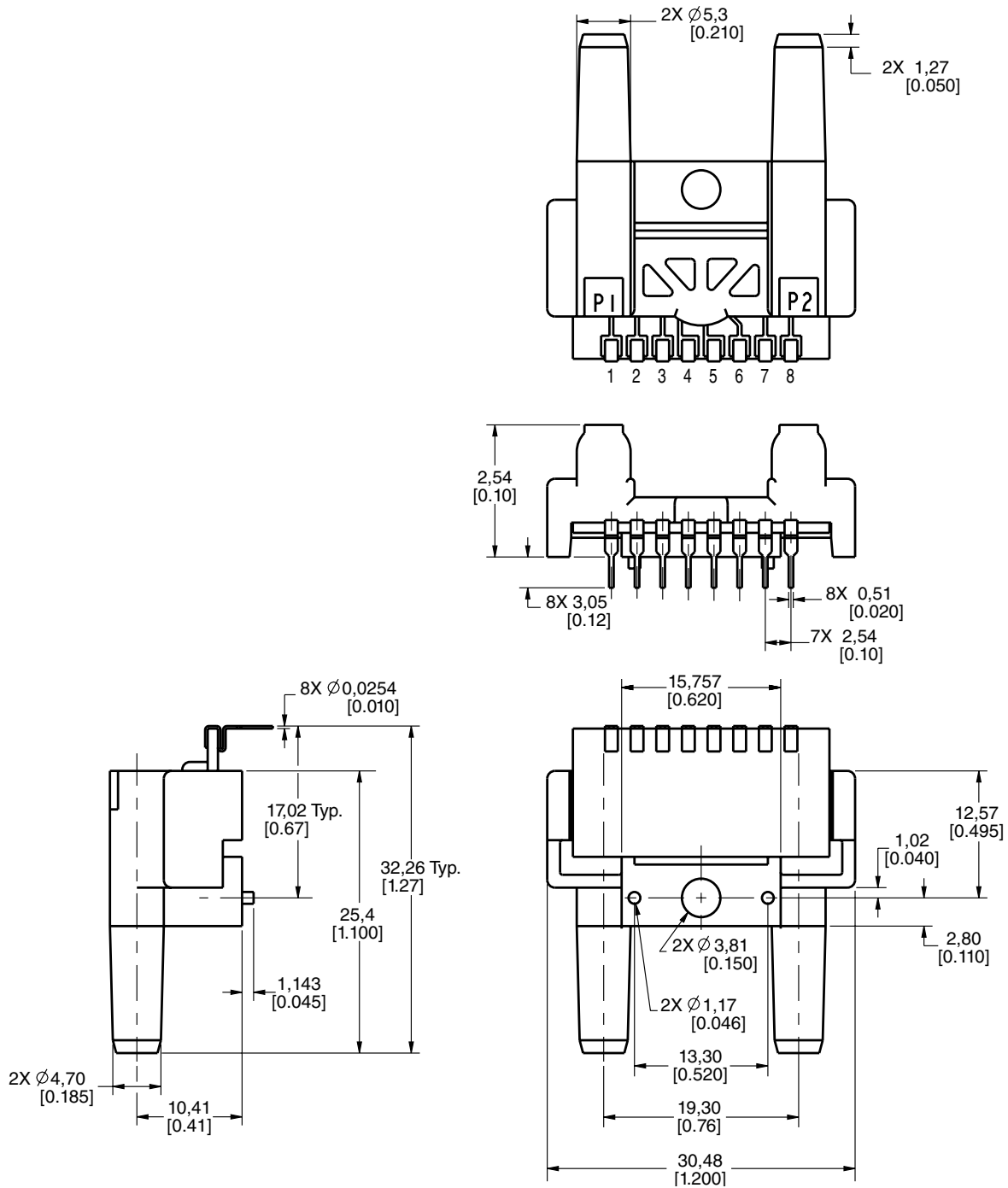

Table 4. Order Guide

Catalog Listing	Description
AWM92100V	AWM90000 series amplified airflow sensor, ± 200 SCCM flow range
AWM92200V	AWM90000 series amplified airflow sensor, ± 2.0 inH ₂ O pressure range

ADDITIONAL INFORMATION

The following associated literature is available at sensing.honeywell.com:

- Airflow Products Line Guide
- Airflow, Force and Pressure Sensors Range Guide
- Product Installation Instructions

⚠ WARNING

PERSONAL INJURY

DO NOT USE these products as safety or emergency stop devices or in any other application where failure of the product could result in personal injury.

Failure to comply with these instructions could result in death or serious injury.

⚠ WARNING

MISUSE OF DOCUMENTATION

- The information presented in this product sheet is for reference only. Do not use this document as a product installation guide.
- Complete installation, operation, and maintenance information is provided in the instructions supplied with each product.

Failure to comply with these instructions could result in death or serious injury.

Sales and Service

Honeywell serves its customers through a worldwide network of sales offices, representatives and distributors. For application assistance, current specifications, pricing or name of the nearest Authorized Distributor, contact your local sales office or email us at info.sc@honeywell.com. Visit us on the Web at sensing.honeywell.com

Phone and Fax:

Asia Pacific	+65 6355-2828 +65 6445-3033 Fax
Europe	+44 (0) 1698 481481 +44 (0) 1698 481676 Fax
Latin America	+1-305-805-8188 +1-305-883-8257 Fax
USA/Canada	+1-800-537-6945 +1-815-235-6847 +1-815-235-6545 Fax

Sensing and Control
Honeywell
1985 Douglas Drive North
Golden Valley, MN 55422
honeywell.com

WARRANTY/REMEDY

Honeywell warrants goods of its manufacture as being free of defective materials and faulty workmanship. Honeywell's standard product warranty applies unless agreed to otherwise by Honeywell in writing; please refer to your order acknowledgement or consult your local sales office for specific warranty details. If warranted goods are returned to Honeywell during the period of coverage, Honeywell will repair or replace, at its option, without charge those items it finds defective. **The foregoing is buyer's sole remedy and is in lieu of all other warranties, expressed or implied, including those of merchantability and fitness for a particular purpose. In no event shall Honeywell be liable for consequential, special, or indirect damages.**

While we provide application assistance personally, through our literature and the Honeywell website, it is up to the customer to determine the suitability of the product in the application.

Specifications may change without notice. The information we supply is believed to be accurate and reliable as of this printing. However, we assume no responsibility for its use.

Honeywell