

SERIES: PESE1-M | **DESCRIPTION:** DC-DC CONVERTER**FEATURES**

- 1 W isolated output
- unregulated output
- compact SMT package
- single/dual output models
- continuous short circuit protection
- extended temperature range (-40~105°C)
- 3 kVdc Vdc isolation
- no load input current as low as 5 mA
- efficiency up to 85%
- UL 62368 approval
- designed to meet EN/BS EN 62368



MODEL	input voltage		output voltage (Vdc)	output current		output power max (W)	ripple & noise ¹ max (mVp-p)	efficiency ² typ (%)
	typ (Vdc)	range (Vdc)		min (mA)	max (mA)			
PESE1-S3-S3-M ⁴	3.3	2.97~3.63	3.3	30	303	1	100	77
PESE1-S3-S5-M ⁴	3.3	2.97~3.63	5	20	200	1	100	82
PESE1-S3-S9-M ⁴	3.3	2.97~3.63	9	11	111	1	100	84
PESE1-S3-S12-M ⁴	3.3	2.97~3.63	12	8	83	1	100	84
PESE1-S3-S15-M ⁴	3.3	2.97~3.63	15	7	67	1	100	84
PESE1-S3-S24-M ⁴	3.3	2.97~3.63	24	4	42	1	100	84
PESE1-S5-S3-M	5	4.5~5.5	3.3	30	303	1	75	74
PESE1-S5-S5-M	5	4.5~5.5	5	20	200	1	75	82
PESE1-S5-S9-M	5	4.5~5.5	9	12	111	1	75	83
PESE1-S5-S12-M	5	4.5~5.5	12	9	84	1	75	83
PESE1-S5-S15-M	5	4.5~5.5	15	7	67	1	75	83
PESE1-S5-S24-M	5	4.5~5.5	24	4	42	1	100	85
PESE1-S5-D5-M	5	4.5~5.5	±5	±10	±100	1	75	82
PESE1-S5-D9-M	5	4.5~5.5	±9	±6	±56	1	75	83
PESE1-S5-D12-M	5	4.5~5.5	±12	±5	±42	1	75	83
PESE1-S5-D15-M	5	4.5~5.5	±15	±4	±34	1	75	83
PESE1-S5-D24-M	5	4.5~5.5	±24	±3	±21	1	100	85
PESE1-S12-S5-M	12	10.8~13.2	5	20	200	1	75	82
PESE1-S12-S9-M	12	10.8~13.2	9	12	111	1	75	83
PESE1-S12-S12-M	12	10.8~13.2	12	9	84	1	75	83
PESE1-S12-S15-M	12	10.8~13.2	15	7	67	1	75	83
PESE1-S12-S24-M	12	10.8~13.2	24	4	42	1	100	85
PESE1-S12-D5-M	12	10.8~13.2	±5	±10	±100	1	75	82
PESE1-S12-D9-M	12	10.8~13.2	±9	±6	±56	1	75	83
PESE1-S12-D12-M	12	10.8~13.2	±12	±5	±42	1	75	83
PESE1-S12-D15-M	12	10.8~13.2	±15	±4	±34	1	75	83
PESE1-S12-D24-M	12	10.8~13.2	±24	±3	±21	1	100	85

MODEL (CONTINUED)

	input voltage		output voltage	output current		output power	ripple & noise ¹	efficiency ²
	typ (Vdc)	range (Vdc)	(Vdc)	min (mA)	max (mA)	max (W)	max (mVp-p)	typ (%)
PESE1-S15-S5-M	15	13.5~16.5	5	20	200	1	75	82
PESE1-S15-S15-M	15	13.5~16.5	15	7	67	1	75	83
PESE1-S15-D15-M	15	13.5~16.5	±15	±4	±34	1	75	83
PESE1-S24-S5-M	24	21.6~26.4	5	20	200	1	75	82
PESE1-S24-S9-M	24	21.6~26.4	9	12	111	1	75	83
PESE1-S24-S12-M	24	21.6~26.4	12	9	84	1	75	83
PESE1-S24-S15-M	24	21.6~26.4	15	7	67	1	75	83
PESE1-S24-S24-M	24	21.6~26.4	24	4	42	1	100	85
PESE1-S24-D5-M	24	21.6~26.4	±5	±10	±100	1	75	82
PESE1-S24-D9-M	24	21.6~26.4	±9	±6	±56	1	75	83
PESE1-S24-D12-M	24	21.6~26.4	±12	±5	±42	1	75	83
PESE1-S24-D15-M	24	21.6~26.4	±15	±4	±34	1	75	83
PESE1-S24-D24-M	24	21.6~26.4	±24	±3	±21	1	100	85

- Notes:
1. Measured at nominal input, 20 MHz bandwidth oscilloscope, with 10 µF tantalum and 1 µF ceramic capacitors on the output.
 2. Measured at nominal input voltage, full load.
 3. All specifications are measured at Ta=25°C, humidity < 75%, nominal input voltage, and rated output load unless otherwise specified.
 4. Model is not UL certified.

PART NUMBER KEY

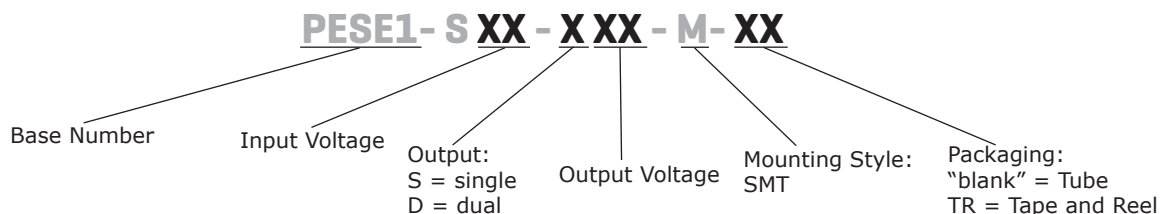

INPUT

parameter	conditions/description	min	typ	max	units
operating input voltage	3.3 Vdc input models	2.97	3.3	3.63	Vdc
	5 Vdc input models	4.5	5	5.5	Vdc
	12 Vdc input models	10.8	12	13.2	Vdc
	15 Vdc input models	13.5	15	16.5	Vdc
	24 Vdc input models	21.6	24	24.4	Vdc
surge voltage	for maximum of 1 second				
	3.3 Vdc input models	-0.7		5	Vdc
	5 Vdc input models	-0.7		9	Vdc
	12 Vdc input models	-0.7		18	Vdc
	15 Vdc input models	-0.7		21	Vdc
	24 Vdc input models	-0.7		30	Vdc
current	3.3 Vdc input models	3.3 Vdc output models		416	mA
		5 Vdc output models		389	mA
		all other models		379	mA
	5 Vdc input models	3.3, 5 Vdc output models		286	mA
		±5 Vdc output models all other models		257 254	mA mA
	12 Vdc input models	5, ±5 Vdc output models		107	mA
9, 12, 15, ±9, ±12, ±15 Vdc output models		106	mA		
24, ±24 Vdc output models		103	mA		
15 Vdc input models	5 Vdc output models		86	mA	
	15, ±15 Vdc output models		85	mA	
24 Vdc input models	5, 9, 12, 15, ±5, ±9, ±12, ±15 Vdc output models		55	mA	
	24, ±24 Vdc output models		53	mA	
filter	filter capacitor				

OUTPUT

parameter	conditions/description	min	typ	max	units
maximum capacitive load ⁴	3.3, 5 Vdc output models			2,400	µF
	±5 Vdc output models			1,200	µF
	9 Vdc output models			1,000	µF
	12, 15 Vdc output models			560	µF
	24, ±12, ±15 Vdc output models			220	µF
	±5 Vdc output models			1,200	µF
	±9 Vdc output models			470	µF
	±24 Vdc output models			100	µF
voltage accuracy	see tolerance envelope curves				
line regulation	for Vin change of 1%				
	3.3 Vdc output models all other models			±1.5 ±1.2	% %
load regulation	from 10% to full load				
	3.3 Vdc output models			20	%
	5, ±5 Vdc output models all other models			15 10	% %
switching frequency	100% load, nominal input voltage		270		kHz
temperature coefficient	at full load		±0.02		%/°C

Note: 4. Tested at input voltage range and full load.

PROTECTIONS

parameter	conditions/description	min	typ	max	units
short circuit protection	continuous, self recovery				

SAFETY AND COMPLIANCE

parameter	conditions/description	min	typ	max	units
isolation voltage	input to output for 1 minute at 1 mA	3,000			Vdc
isolation resistance	input to output at 500 Vdc	1,000			MΩ
isolation capacitance	input to output, 100 kHz / 0.1 V		20		pF
safety approvals	certified to 62368-1: UL designed to meet 62368: EN/BS EN				
conducted emissions	CISPR32/EN55032, class B (external circuit required, see Figures 3, 4)				
radiated emissions	CISPR32/EN55032, class B (external circuit required, see Figures 3, 4)				
ESD	IEC/EN61000-4-2, air ± 8 kV; contact ± 4 kV, class B				
MTBF	as per MIL-HDBK-217F, 25°C	3,500,000			hours
RoHS	yes				

ENVIRONMENTAL

parameter	conditions/description	min	typ	max	units
operating temperature	see derating curves	-40		105	°C
storage temperature		-55		125	°C
storage humidity	non-condensing			95	%
case temperature rise	3.3 Vdc output model at 25°C all other models at 25°C		25 15		°C °C

DERATING CURVES

TEMPERATURE DERATING CURVE
3.3 Vdc input models

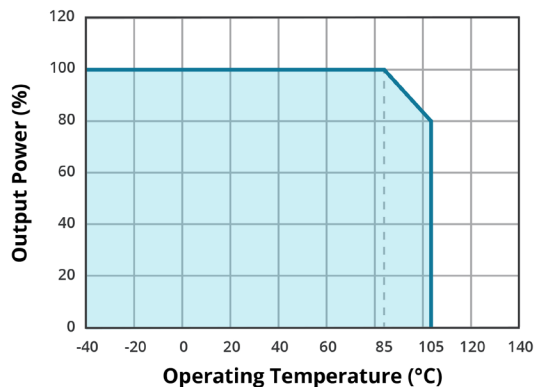

TEMPERATURE DERATING CURVE
all other input models

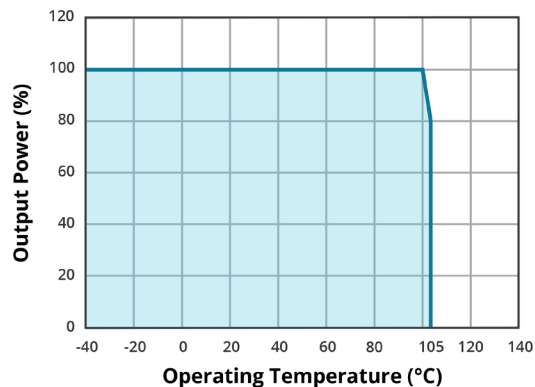

DERATING CURVES (CONTINUED)

OUTPUT REGULATION CURVE
3.3 Vdc input / 3.3 Vdc output
(nominal input)

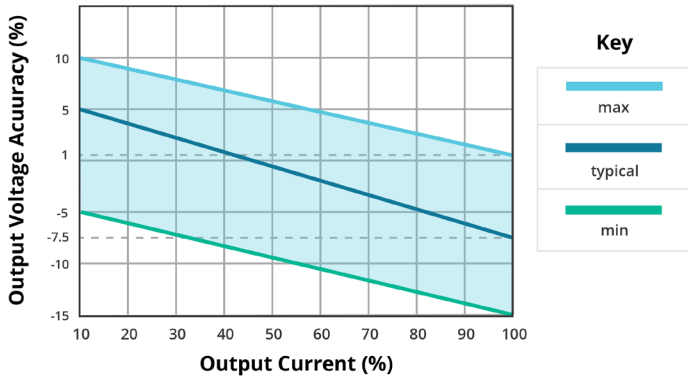

OUTPUT REGULATION CURVE
3.3 Vdc input / all other output models
(nominal input)

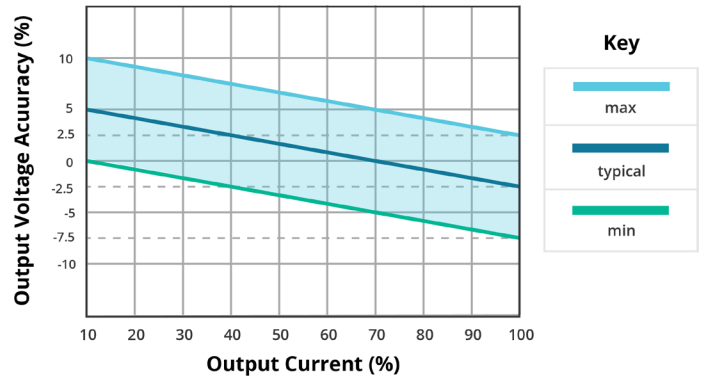

OUTPUT REGULATION CURVE
5 Vdc input / 3.3 Vdc output model
(nominal input)

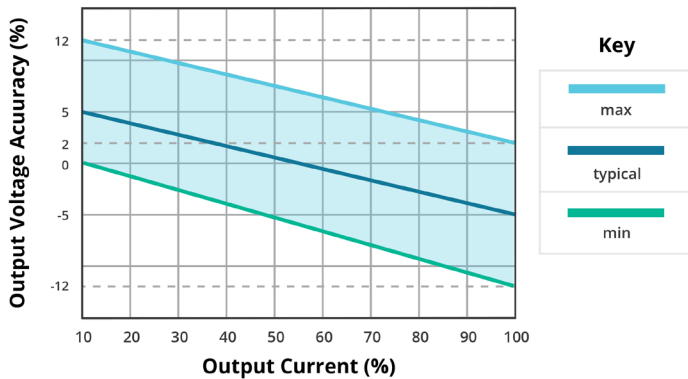

OUTPUT REGULATION CURVE
5 Vdc input / all other output models
(nominal input)

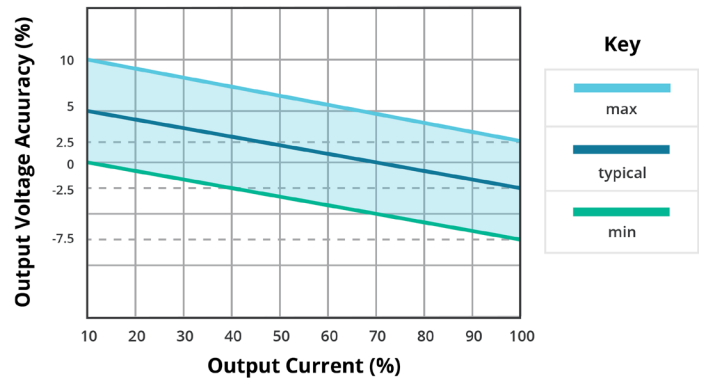

OUTPUT REGULATION CURVE
all other input and output models
(nominal input)

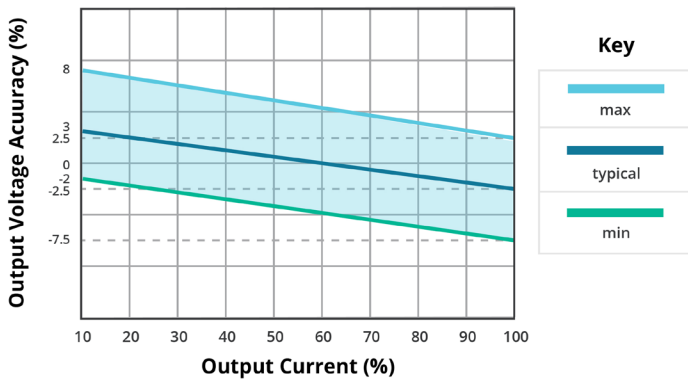

SOLDERABILITY

parameter	conditions/description	min	typ	max	units
reflow soldering	maximum duration time ≤60 s at 217°C			245	°C

Note: 3. Please refer to IPC/JEDEC J-STD-020D.1 for additional information.

MECHANICAL

parameter	conditions/description	min	typ	max	units
dimensions	single output models: 13.20 x 11.40 x 7.25 [0.520 x 0.449 x 0.285 inch] dual output models: 15.24 x 11.40 x 7.25 [0.600 x 0.449 x 0.285 inch]				mm mm
case material	black flame-retardant and heat-resistant plastic (UL94V-0)				
weight			1.4		g

MECHANICAL DRAWING (SINGLE OUTPUT)

units: mm [inch]
tolerance: ±0.25[±0.010]
pin section tolerance: ±0.10[±0.004]

PIN CONNECTIONS	
PIN	Function
1	GND
2	Vin
4	0V
5	+Vout
8	NC

NC = No connect

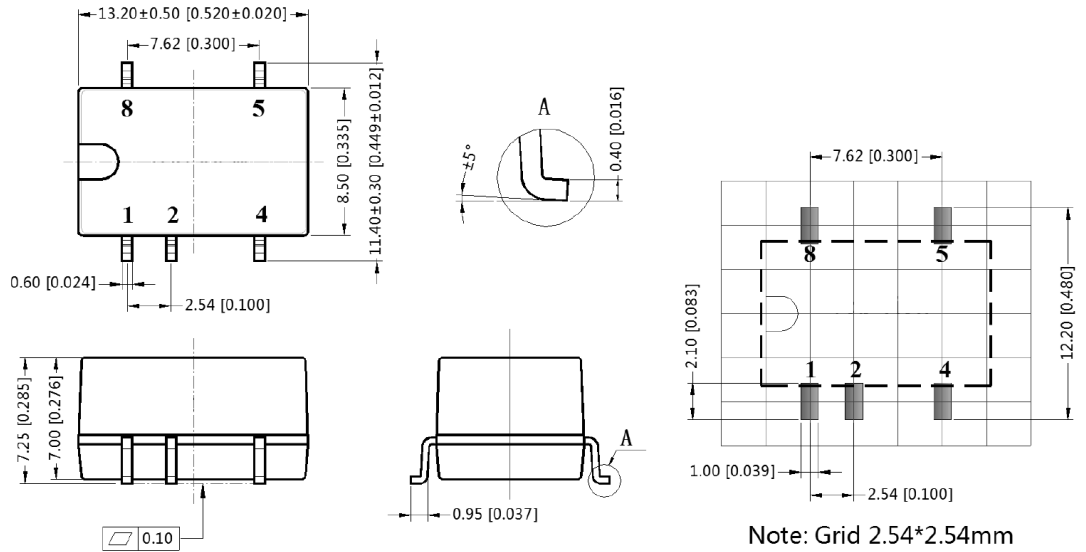

Note: Grid 2.54*2.54mm
Recommended PCB Layout
Top View

MECHANICAL DRAWING (DUAL OUTPUT)

units: mm [inch]
 tolerance: ± 0.25 [± 0.010]
 pin section tolerance: ± 0.10 [± 0.004]

PIN CONNECTIONS	
PIN	Function
1	GND
2	V _{in}
4	0V
5	-V _{out}
7	+V _{out}
10	NC

NC = No connect

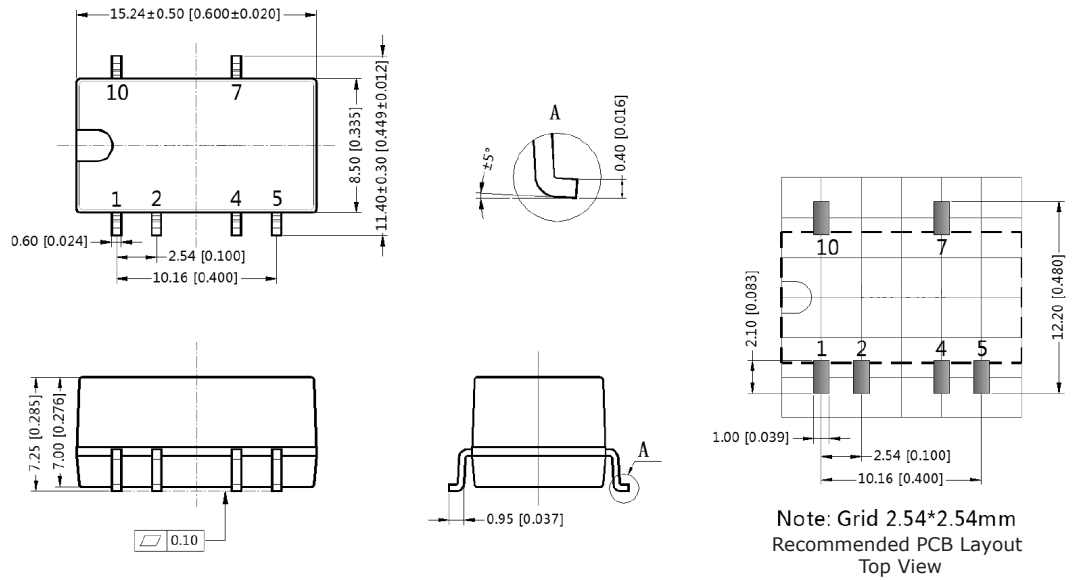

APPLICATION CIRCUIT

If you want to further reduce the input and output ripple, a filter capacitor may be connected to the input and output terminals (Figures 1 & 2) provided that the capacitance is less than the maximum capacitive load of the model, otherwise start-up problems may be caused if the capacitance is too large.

Figure 1
Single Output Models

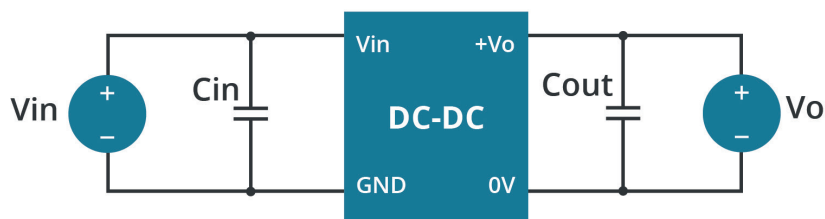

Table 1

Vin (Vdc)	Cin (μF / V)	Vo (Vdc)	Co (μF / V)
3.3	4.7 μF / 16 V	3.3	10 μF / 16 V
		5	10 μF / 16 V
		9	4.7 μF / 16 V
		12	2.2 μF / 16 V
		15	1 μF / 25 V
		24	0.47 μF / 50 V
5	4.7 μF	3.3, 5	10 μF
		9	4.7 μF
		12	2.2 μF
		15	1.0 μF
		24	0.47 μF
12	2.2 μF / 25 V	5	10 μF / 16 V
15	2.2 μF / 25 V	9	2.2 μF / 16 V
24	1 μF / 50 V	12	2.2 μF / 25 V
--	--	15	1 μF / 25 V
--	--	24	1 μF / 50 V

Figure 2
Dual Output Models

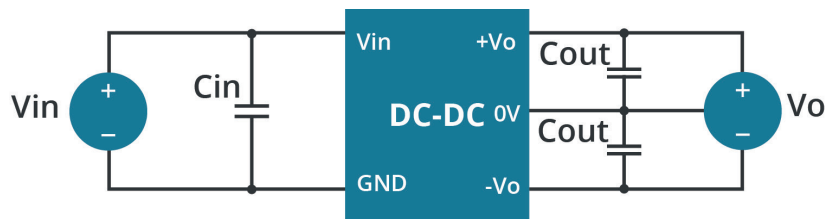

Table 2

Vin (Vdc)	Cin (μF / V)	Vo (Vdc)	Co (μF / V)
5	4.7 μF	±5	4.7 μF
		±9	2.2 μF
		±12, ±15, ±24	1 μF
12	2.2 μF / 25 V	±5	4.7 μF / 16 V
15	2.2 μF / 25 V	±9	1 μF / 16 V
24	1 μF / 50	±12	1 μF / 25 V
--	--	±15	0.47 μF / 25 V
--	--	±24	0.47 μF / 50 V

EMC RECOMMENDED CIRCUIT

Figure 3
Single Output Models

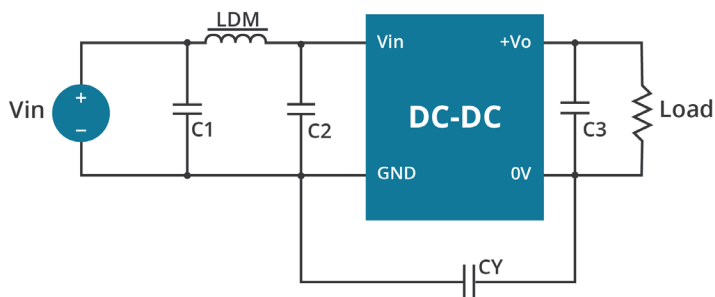

Figure 4
Dual Output Models

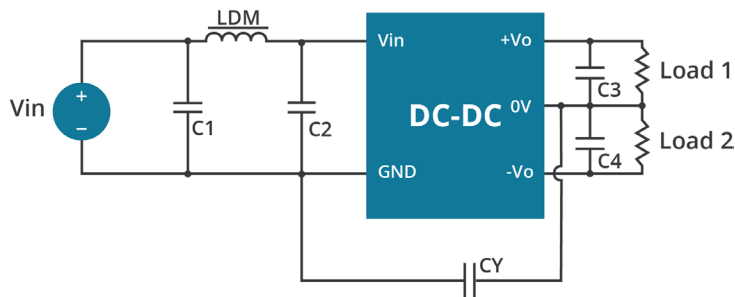

Table 3

Recommended External Circuit Components				
Vin (Vdc)	Vo (Vdc)	3.3, 5, 9	12, 15, 24	±5, ±9, ±12, ±15, ±24
3.3	C1, C2	4.7 μF / 16 V		-
	C3	refer to the Co in Tables 1		-
	CY	270 pF / 4 kVdc		-
	LDM	6.8 μH		-
5	C1, C2	4.7 μF / 25 V	4.7 μF / 25 V	4.7 μF / 50 V
	C3	refer to the Co in Tables 1, 2		
	CY	--	1 pF / 4 kVdc	270 pF / 3 kV
	LDM	6.8 μH	6.8 μH	6.8 μH
12, 15, 24	C1	4.7 μF / 50 V		
	C2	4.7 μF / 50 V		
	CY	270 pF / 2 kVdc		
	C3, C4	refer to the Co in Tables 1, 2		
	LDM	6.8 μH		

REVISION HISTORY

rev.	description	date
1.0	initial release	05/10/2019
1.01	safeties updated in features and safety line, packaging removed	01/14/2021
1.02	model table updated	03/29/2021
1.03	product image updated	04/20/2021
1.04	derating curves and circuit figures updated	07/07/2021
1.05	3.3 Vdc input models added to specification	06/21/2022
1.06	CE certification updated	11/11/2022
1.07	solderability updated	09/13/2023
1.08	table 3 updated	11/30/2023

The revision history provided is for informational purposes only and is believed to be accurate.



CUI INC
a bel group

Headquarters
20050 SW 112th Ave.
Tualatin, OR 97062
800.275.4899

Fax 503.612.2383
cui.com
techsupport@cui.com

CUI offers a two (2) year limited warranty. Complete warranty information is listed on our website.

CUI reserves the right to make changes to the product at any time without notice. Information provided by CUI is believed to be accurate and reliable. However, no responsibility is assumed by CUI for its use, nor for any infringements of patents or other rights of third parties which may result from its use.

CUI products are not authorized or warranted for use as critical components in equipment that requires an extremely high level of reliability. A critical component is any component of a life support device or system whose failure to perform can be reasonably expected to cause the failure of the life support device or system, or to affect its safety or effectiveness.