

SERIES: AE15-EW | **DESCRIPTION:** DC-DC CONVERTER**FEATURES**

- 15 watts
- high operating temp -40 to +70°C
- 4,000 Vac isolation
- extra wide input voltage 10:1
- input voltage up to 1 kVdc
- OVP protection
- output short circuit protection
- board mounted
- EN 62109 approved

**MODEL**

MODEL	input voltage range (Vdc)	output voltage (Vdc)	output current		output power max (W)	ripple & noise ¹ max (mVp-p)	efficiency ² typ (%)
			min (A)	max (A)			
AE15-EW-S12	100~1000	12	0	1.25	15	200	77
AE15-EW-S15	100~1000	15	0	1.00	15	200	78
AE15-EW-S24*	100~1000	24	0	0.625	15	200	80

Notes:

1. Measured at nominal input, 20 MHz bandwidth oscilloscope, with 10 μ F electrolytic and 1 μ F ceramic capacitors on the output.
2. Measured at 200 Vdc input voltage, full load.
3. All specifications are measured at $T_a=25^\circ\text{C}$, humidity < 75%, nominal input voltage, and rated output load unless otherwise specified.
4. * Discontinued model.

PART NUMBER KEY**AE15-EW - SXX**

Base Number

Output Voltage

INPUT

parameter	conditions/description	min	typ	max	units
operating input voltage		100		1000	Vdc
current	at 200 Vdc at 600 Vdc at 1000 Vdc			120 40 22	mA mA mA
inrush current	at 200 Vdc at 600 Vdc at 1000 Vdc		7 20 30		A A A
input fuse	2 A / 1000 Vdc (external)				

OUTPUT

parameter	conditions/description	min	typ	max	units
maximum capacitive load	12 Vdc output model 15 Vdc output model 24 Vdc output model			2,000 1,200 470	μ F μ F μ F
voltage accuracy			± 1	± 2	%
line regulation	from low line to high line, full load		± 0.5	± 1	%
load regulation	from 0% to full load		± 0.5	± 1	%
delay time	from $V_{in} = 0$ V to 90% of rated output voltage			1	s
switching frequency				75	kHz
temperature coefficient	at full load		± 0.02		%/°C

PROTECTIONS

parameter	conditions/description	min	typ	max	units
over voltage protection	12 Vdc output model 15 Vdc output model 24 Vdc output model			15 19 28	Vdc Vdc Vdc
over current protection	automatic recovery	110			%
short circuit protection	continuous, automatic recovery				

SAFETY AND COMPLIANCE

parameter	conditions/description	min	typ	max	units
isolation voltage	input to output for 1 minute	4,000			Vac
safety approvals	EN 62109				
conducted emissions	CISPR22/EN55022, class A (external circuit required, see Figure 2)				
radiated emissions	CISPR22/EN55022, class A (external circuit required, see Figure 2)				
ESD	IEC/EN61000-4-2, contact ± 6 kV/air ± 8 kV, class B				
radiated immunity	IEC/EN61000-4-3, 10V/m, class A				
EFT/burst	IEC/EN61000-4-4, ± 4 kV, class B (external circuit required, see Figure 2)				
surge	IEC/EN61000-4-5, ± 2 kV, class B (external circuit required, see Figure 2)				
conducted immunity	IEC/EN61000-4-6, 10 Vr.m.s, class A				
MTBF	as per MIL-HDBK-217F, 25°C	300,000			hours
RoHS	2011/65/EU				

ENVIRONMENTAL

parameter	conditions/description	min	typ	max	units
operating temperature	see derating curves	-40		70	°C
storage temperature		-40		105	°C
storage humidity	non-condensing			95	%
altitude				2000	m

SOLDERABILITY

parameter	conditions/description	min	typ	max	units
hand soldering	for 3~5 seconds	350	360	370	°C
wave soldering	for 5~10 seconds	255	260	265	°C

MECHANICAL

parameter	conditions/description	min	typ	max	units
dimensions	70.00 x 48.00 x 23.50 [2.756 x 1.890 x 0.925 inch]				mm
case material	black flame-retardant heat-proof plastic (UL94V-0)				
weight			95		g

MECHANICAL DRAWING

units: mm [inch]

tolerance: ± 0.50 [± 0.020]pin diameter tolerance: ± 0.10 [± 0.004]

PIN CONNECTIONS	
PIN	Function
1	NC
2	-Vin
3	+Vin
4	+Vout
5	-Vout

NC=no connection

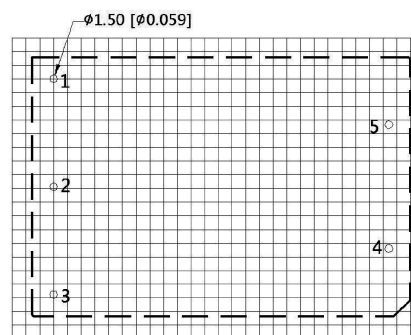
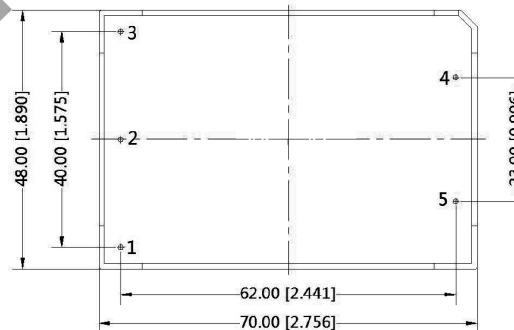
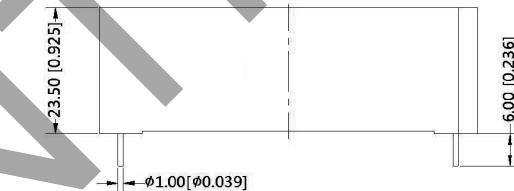

Note: Grid 2.54*2.54mm

Recommended PCB Layout
Top View

DERATING CURVES

**TEMPERATURE DERATING CURVE
(100~150 Vdc Input voltage)**

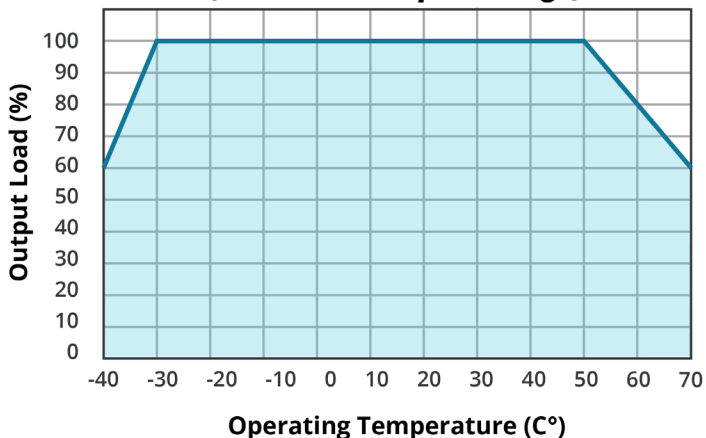

**TEMPERATURE DERATING CURVE
(150~1000 Vdc Input voltage)**

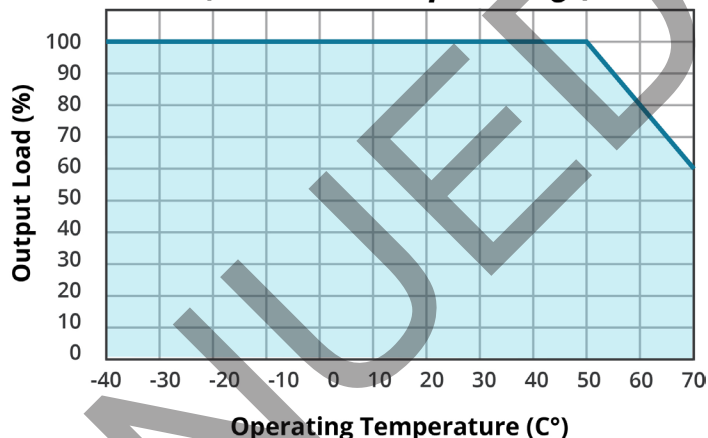

**INPUT VOLTAGE DERATING CURVE
25°C**

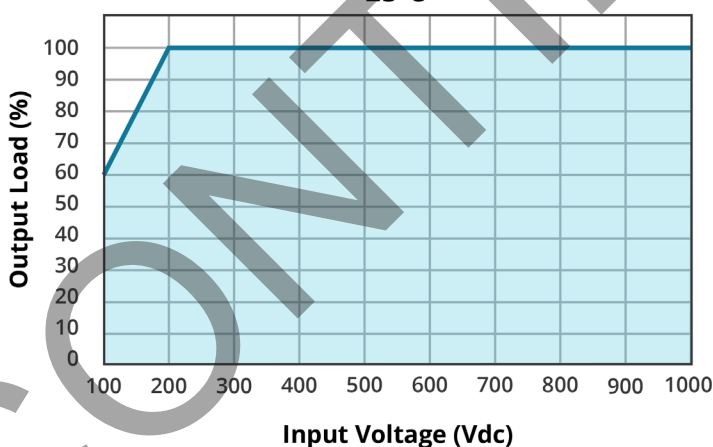

EFFICIENCY CURVES

**EFFICIENCY VS INPUT VOLTAGE
AE15-EW-S12**

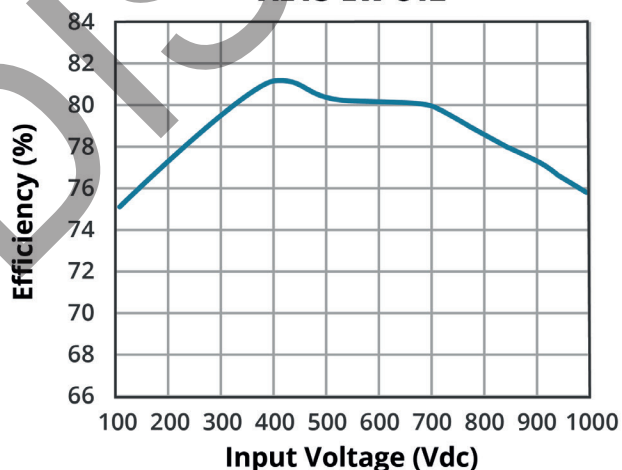

**EFFICIENCY VS OUTPUT LOAD
AE15-EW-S12**

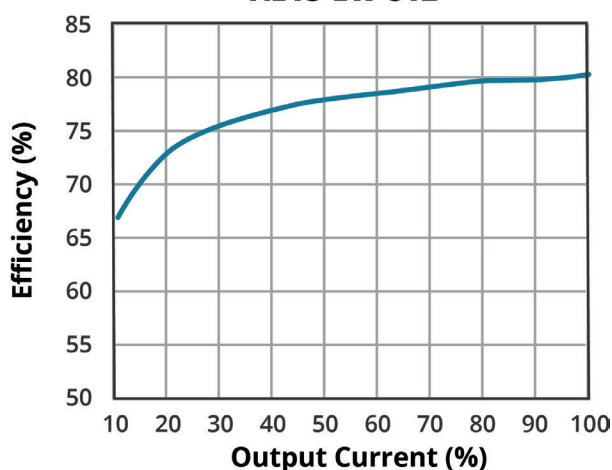

EFFICIENCY CURVES (CONTINUED)

**EFFICIENCY VS INPUT VOLTAGE
AE15-EW-S15**

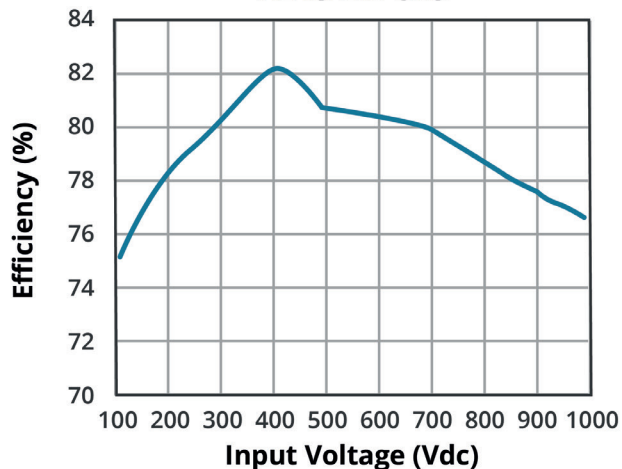

**EFFICIENCY VS OUTPUT LOAD
AE15-EW-S15**

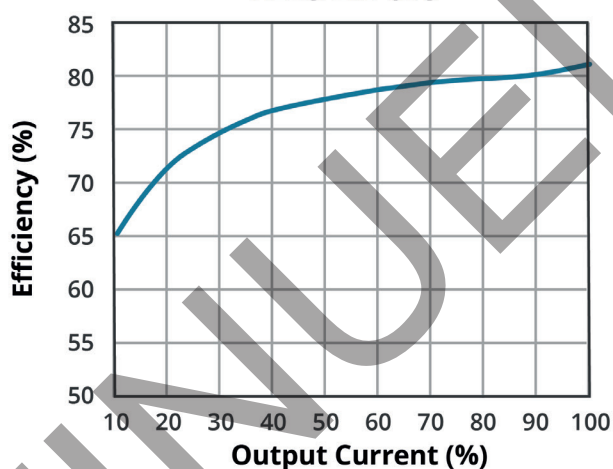

**EFFICIENCY VS INPUT VOLTAGE
AE15-EW-S24**

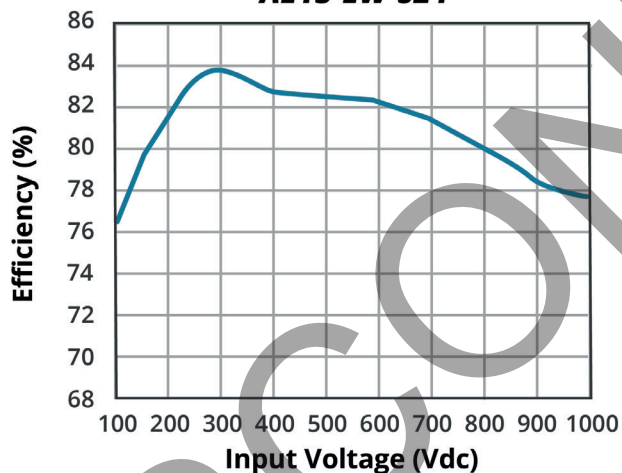

**EFFICIENCY VS OUTPUT LOAD
AE15-EW-S24**

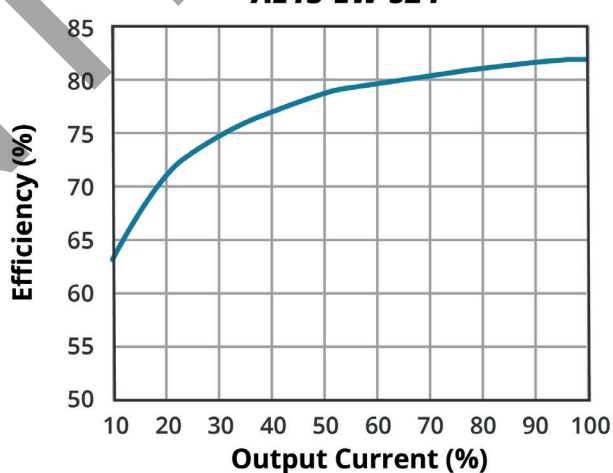

APPLICATION CIRCUIT

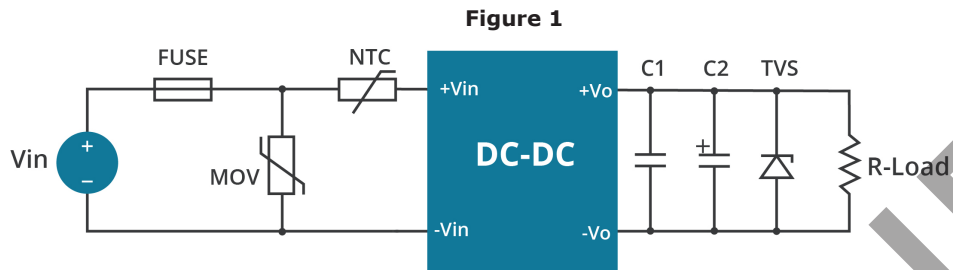

Table 1

Vout (Vdc)	Fuse	MOV	NTC	C1 (μ F)	C2 (μ F)	TVS
12	2 A / 1000 Vdc	S14K880	10D-11	1	120	SMBJ15A
15	2 A / 1000 Vdc	S14K880	10D-11	1	120	SMBJ20A
24	2 A / 1000 Vdc	S14K880	10D-11	1	68	SMBJ33A

EMC RECOMMENDED CIRCUIT

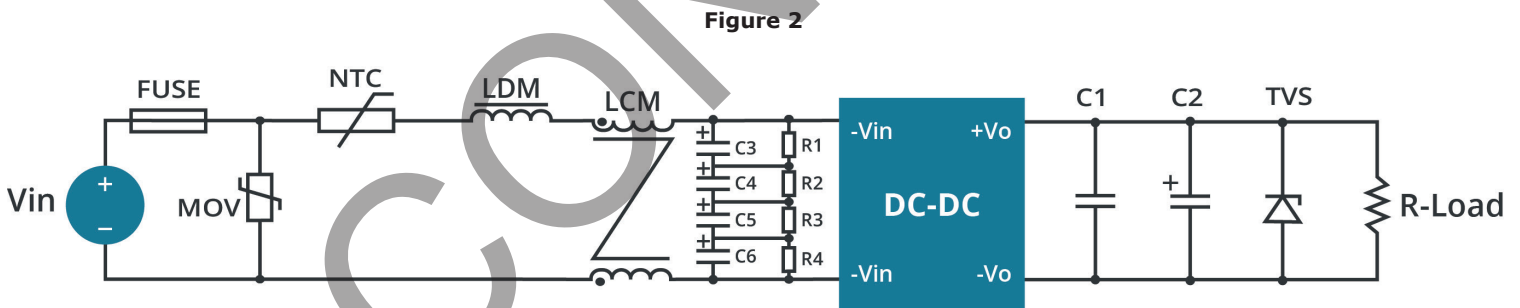

Table 2

Recommended External Circuit Components	
FUSE	2 A/1000 Vdc
MOV	S14K880
C3, C4, C5, C6	47 μ F/400 Vdc
R1, R2, R3, R4	1 M Ω /2 W
NTC	10D-11
LDM	4.7 mH/0.38 A
LCM	10 mH

Note: See also Table 1.

- Notes:
1. C1 is a ceramic capacitor used to filter high frequency noise.
 2. C2 is electrolytic and is recommended to be high frequency and low resistance. For capacitance and current of the capacitor, refer to the datasheet provided by the manufacturer. Capacitance withstand voltage derating should be 80% or above.

REVISION HISTORY

rev.	description	date
1.0	initial release	09/13/2017
1.01	company logo updated	04/12/2021
1.02	derating curves, efficiency curves and circuit figures updated	07/29/2021
1.03	discontinued AE15-EW-S24	02/02/2023

The revision history provided is for informational purposes only and is believed to be accurate.



CUI INC
a bel group

Headquarters
20050 SW 112th Ave.
Tualatin, OR 97062
800.275.4899

Fax 503.612.2383
cui.com
techsupport@cui.com

CUI offers a two (2) year limited warranty. Complete warranty information is listed on our website.

CUI reserves the right to make changes to the product at any time without notice. Information provided by CUI is believed to be accurate and reliable. However, no responsibility is assumed by CUI for its use, nor for any infringements of patents or other rights of third parties which may result from its use.

CUI products are not authorized or warranted for use as critical components in equipment that requires an extremely high level of reliability. A critical component is any component of a life support device or system whose failure to perform can be reasonably expected to cause the failure of the life support device or system, or to affect its safety or effectiveness.