

**CUI INC**

a bel group

date 04/09/2024

page 1 of 7

SERIES: V78-500 | DESCRIPTION: NON-ISOLATED SWITCHING REGULATOR**FEATURES**

- 0.5 A current output
- high efficiency up to 96%
- no heat sink required
- pin compatible to LM78XX linear regulators
- available in straight and right angle SIP packages
- low ripple and noise
- short circuit protection, thermal shutdown
- wide temperature (-40~85°C)



MODEL	input voltage		output voltage (Vdc)	output current max (mA)	output power max (W)	ripple and noise ¹ max (mVp-p)	efficiency	
	typ (Vdc)	range (Vdc)					Vin min (%)	Vin max (%)
V7801-500	12	4.75~26	1.5	500	0.75	35	66	76
V78X2-500*	12	4.75~28	1.8	500	0.9	35	67	79
V7802-500	12	4.75~28	2.5	500	1.25	35	73	85
V7803-500*	24	4.75~28	3.3	500	1.65	35	80	90
V7805-500*	24	6.5~32	5.0	500	2.5	35	84	93
V7806-500*	24	8~32	6.5	500	3.25	35	87	94
V7809-500*	24	11~32	9.0	500	4.5	35	91	95
V7812-500*	24	15~32	12	500	6	35	92	95
V7815-500*	24	18~32	15	500	7.5	35	93	96

Notes: 1. ripple and noise are measured at 20 MHz BW

*. Discontinued model

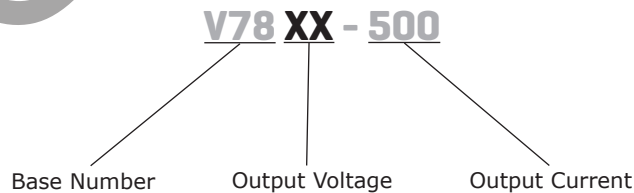
PART NUMBER KEY

INPUT

parameter	conditions/description	min	typ	max	units
operating input voltage	1.5 V output	4.75	12	26	Vdc
	1.8 V output	4.75	12	28	Vdc
	2.5 V output	4.75	12	28	Vdc
	3.3 V output	4.75	24	28	Vdc
	5 V output	6.5	24	32	Vdc
	6 V output	8	24	32	Vdc
	9 V output	11	24	32	Vdc
	12 V output	15	24	32	Vdc
	15 V output	18	24	32	Vdc

OUTPUT

parameter	conditions/description	min	typ	max	units
line regulation	Vin = min ~ max, at full load	1.5~2.5 V models	±0.5	±1.0	%
		3.3~15 V models	±0.2	±0.4	%
load regulation	measured from 10% load to full load	1.5~2.5 V models	±0.4	±0.75	%
		3.3~15 V models	±0.4	±0.6	%
voltage accuracy	100% load		±2	±3	%
switching frequency	100% load, input voltage range	280	330	450	kHz
temperature coefficient				±0.02	%/°C

PROTECTIONS

parameter	conditions/description	min	typ	max	units
short circuit protection	continuous, automatic recovery				
thermal shutdown	internal IC junction		150		°C

SAFETY AND COMPLIANCE

parameter	conditions/description	min	typ	max	units
MTBF		2,000,000			hours
RoHS compliant	yes				

ENVIRONMENTAL

parameter	conditions/description	min	typ	max	units
operating temperature		-40		85	°C
storage temperature		-55		125	°C
case temperature				100	°C
storage humidity	non-condensing			95	%
temperature rise	at full load		25		°C
lead temperature	1.5 mm from case for 10 seconds			300	°C

DERATING CURVES

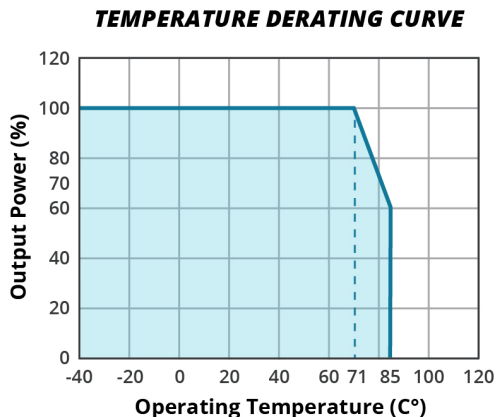

MECHANICAL

parameter	conditions/description	min	typ	max	units
dimensions	0.457 x 0.297 x 0.400 (11.6 x 7.55 x 10.16 mm)				inch
case material	plastic (UL94-V0)				
weight			2.0		g

MECHANICAL DRAWING

units: mm [inches]
 tolerance: ±0.25 [±0.010]
 pin section tolerance: ±0.10 mm [±0.004]

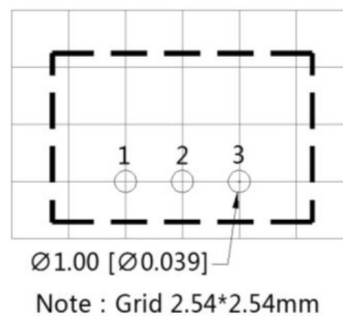
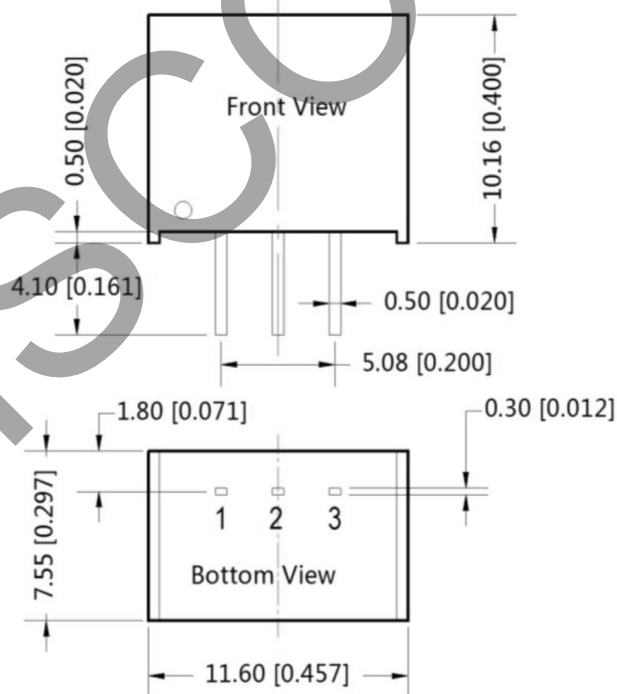

PIN CONNECTIONS	
PIN	FUNCTION
1	+Vin
2	GND
3	+Vo

TYPICAL APPLICATION CIRCUIT

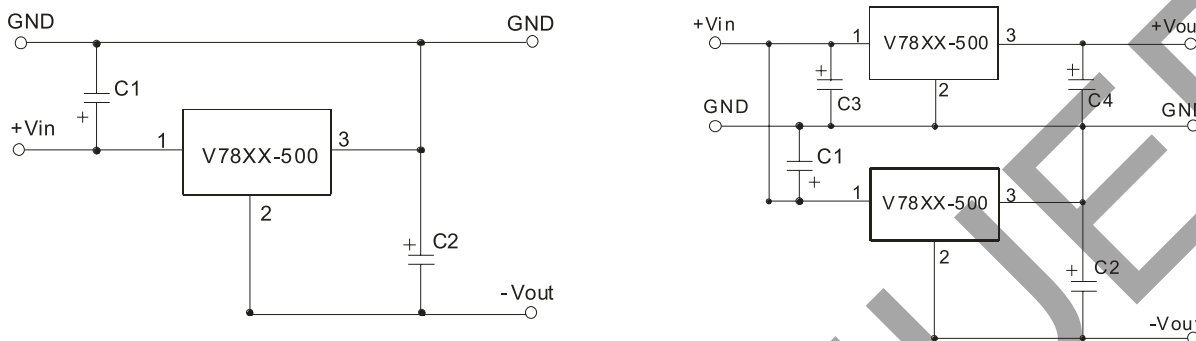

1. C1 and C2 are required and should be fitted close to the converter pins
2. For the capacitance of C1 and C2, see the external capacitor table. Low ESR types should be chosen
3. C3: a low ESR capacitor is required to keep the noise at the converter to a minimum. Ceramic capacitors are preferred, but tantalum or low ESR electrolytic capacitors may also suffice; General use 10 μ F/50V ceramic capacitor. C4 Optional; General use 100 μ F/25V electrolytic capacitor.
4. No parallel connection or plug and play

TEST CIRCUIT

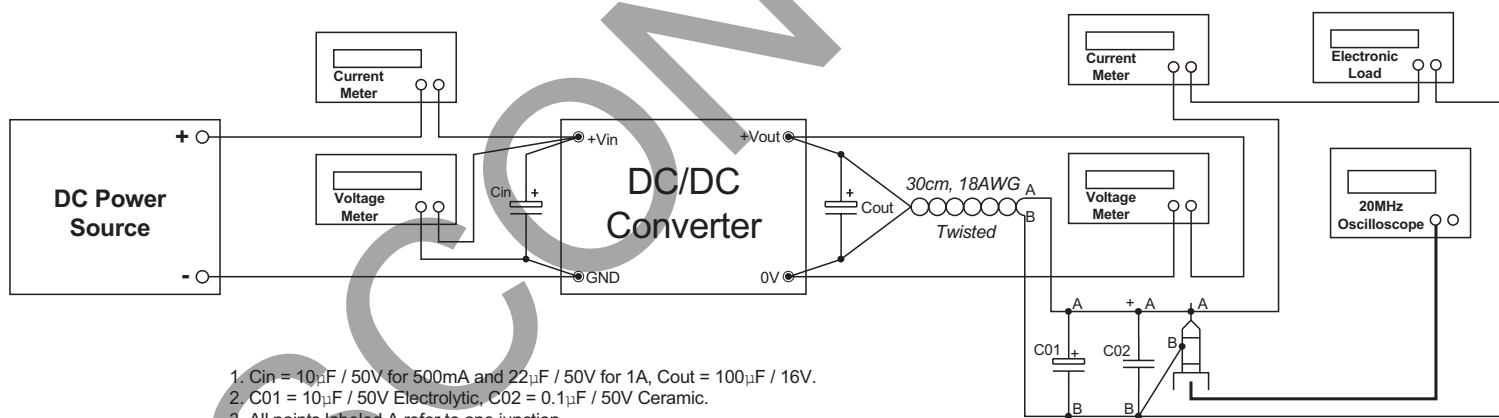

1. $C_{in} = 10\mu\text{F} / 50\text{V}$ for 500mA and $22\mu\text{F} / 50\text{V}$ for 1A, $C_{out} = 100\mu\text{F} / 16\text{V}$.
2. C01 = 10 μ F / 50V Electrolytic, C02 = 0.1 μ F / 50V Ceramic.
3. All points labeled A refer to one junction.
4. All points labeled B refer to one junction.
5. Use a short ground loop for probing. Do not use a wired ground clip.

EFFICIENCY AND RIPPLE

Efficiency

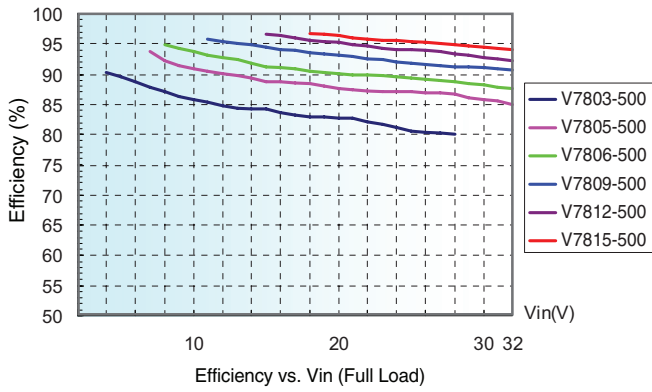

Output Ripple

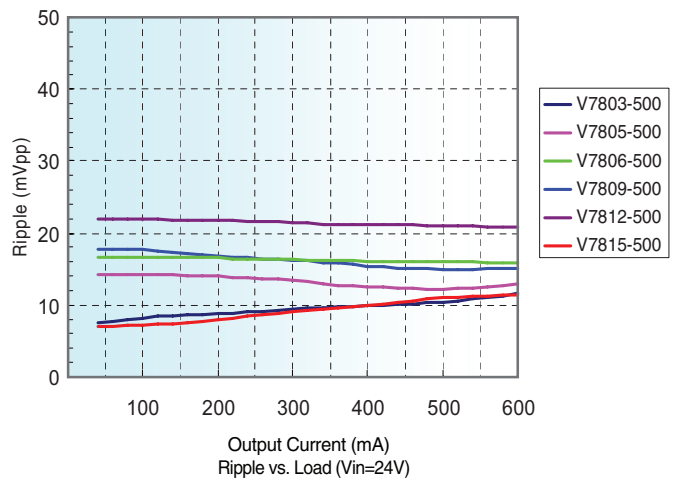
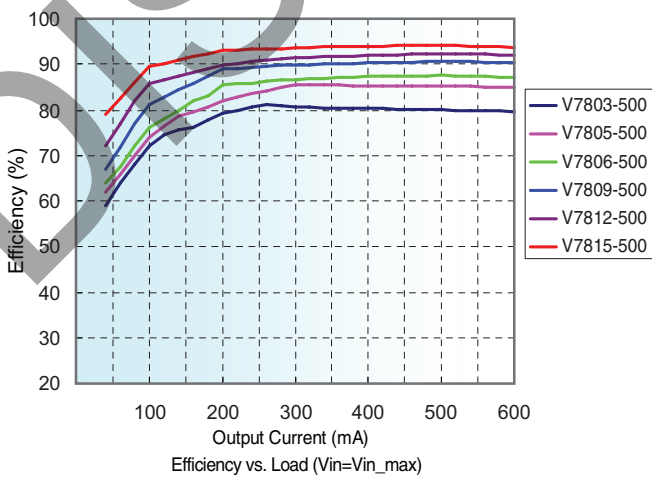
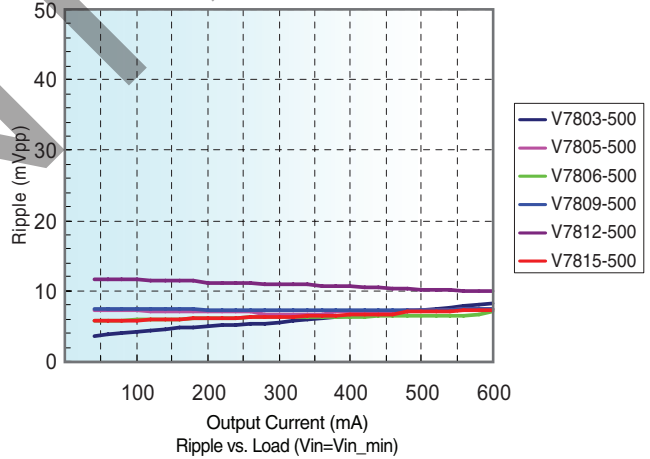
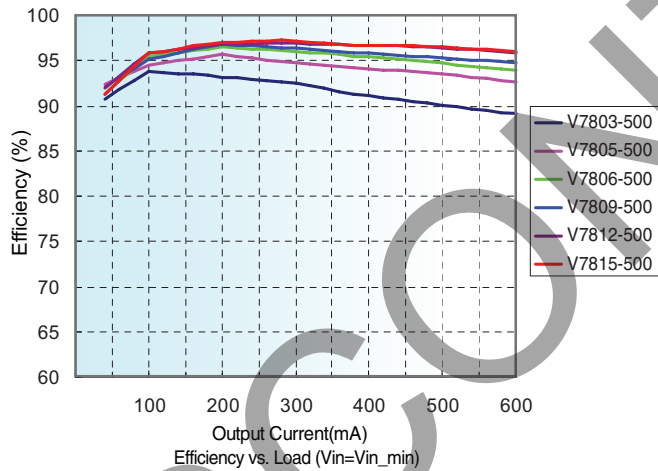
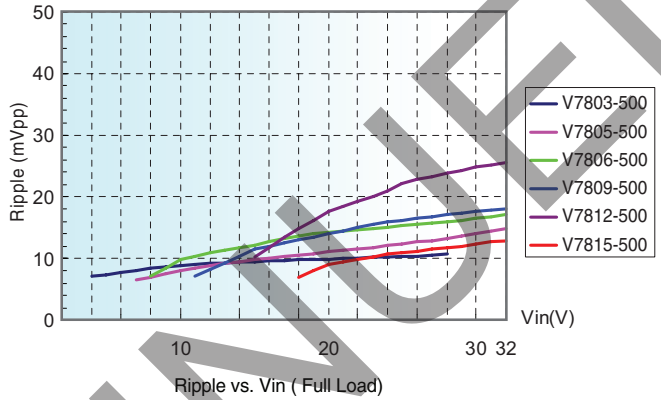

EXTERNAL CAPACITOR TABLE

Part Number	C1,C3 (Ceramic Capacitor)	C2,C4 (Ceramic Capacitor)
V7801-500	10 μ F/50V	22 μ F/6.3V
V78X2-500	10 μ F/50V	22 μ F/6.3V
V7802-500	10 μ F/50V	22 μ F/6.3V
V7803-500	10 μ F/50V	22 μ F/6.3V
V7805-500	10 μ F/50V	22 μ F/10V
V78X6-500	10 μ F/50V	10 μ F/10V
V7809-500	10 μ F/50V	10 μ F/16V
V7812-500	10 μ F/50V	10 μ F/25V
V7815-500	10 μ F/50V	10 μ F/25V

REVISION HISTORY

rev.	description	date
1.0	initial release	07/13/2010
1.01	new template applied	04/18/2012
1.02	V-Infinity branding removed	09/04/2012
1.03	updated typical application circuits	09/25/2012
1.04	updated external capacitor values	11/08/2012
1.05	discontinued V78X2-500 model	06/24/2019
1.06	company logo updated	04/14/2021
1.07	discontinued model V7809-500	12/14/2022
1.08	discontinued model V7806-500	02/07/2023
1.09	efficiency and mechanical dimensions updated	07/21/2023
1.10	discontinued models V7803-500 & V7815-500	10/04/2023
1.11	discontinued models V7801-500, V7802-500, V7805-500 & V7812-500	04/09/2024

The revision history provided is for informational purposes only and is believed to be accurate.



CUI INC

a bel group

Headquarters
20050 SW 112th Ave.
Tualatin, OR 97062
800.275.4899

Fax 503.612.2383
cui.com
techsupport@cui.com

CUI offers a two (2) year limited warranty. Complete warranty information is listed on our website.

CUI reserves the right to make changes to the product at any time without notice. Information provided by CUI is believed to be accurate and reliable. However, no responsibility is assumed by CUI for its use, nor for any infringements of patents or other rights of third parties which may result from its use.

CUI products are not authorized or warranted for use as critical components in equipment that requires an extremely high level of reliability. A critical component is any component of a life support device or system whose failure to perform can be reasonably expected to cause the failure of the life support device or system, or to affect its safety or effectiveness.