

TRAVEO™ T2G Cluster 4M Lite Kit user guide

KIT_T2G_C-2D-4M_LITE

About this document

Scope and purpose

This user guide enables users to use the KIT_T2G_C-2D-4M_LITE (also known as TRAVEO™ T2G Cluster 4M Lite) low-cost evaluation kit. It is based on the CYT3DL device from the TRAVEO™ Cluster 2D family of microcontrollers with on-board EZ-USB™ FX3.

This document describes the features and functions of the TRAVEO™ T2G Cluster 4M lite kit. This document also provides detailed information on available interfaces and usage of all the hardware interfaces.

Intended audience

This document is intended for software and hardware engineers for evaluating the TRAVEO™ T2G Cluster 2D family CYT3DL device.

Evaluation board

This board is to be used during the design-in process for software evaluation.

Note: PCB and auxiliary circuits are NOT optimized for final customer design.

Reference board/Kit

Product(s) embedded on a PCB with a focus on specific applications and defined use cases that may include software. PCB and auxiliary circuits are optimized for the requirements of the target application.

Note: Boards do not necessarily meet safety, EMI, quality standards (for example, UL, CE) requirements

Important notice

Important notice

“Evaluation Boards and Reference Boards” shall mean products embedded on a printed circuit board (PCB) for demonstration and/or evaluation purposes, which include, without limitation, demonstration, reference and evaluation boards, kits and design (collectively referred to as “Reference Board”).

Environmental conditions have been considered in the design of the Evaluation Boards and Reference Boards provided by Infineon Technologies. The design of the Evaluation Boards and Reference Boards has been tested by Infineon Technologies only as described in this document. The design is not qualified in terms of safety requirements, manufacturing and operation over the entire operating temperature range or lifetime.

The Evaluation Boards and Reference Boards provided by Infineon Technologies are subject to functional testing only under typical load conditions. Evaluation Boards and Reference Boards are not subject to the same procedures as regular products regarding returned material analysis (RMA), process change notification (PCN) and product discontinuation (PD).

Evaluation Boards and Reference Boards are not commercialized products, and are solely intended for evaluation and testing purposes. In particular, they shall not be used for reliability testing or production. The Evaluation Boards and Reference Boards may therefore not comply with CE or similar standards (including but not limited to the EMC Directive 2004/EC/108 and the EMC Act) and may not fulfill other requirements of the country in which they are operated by the customer. The customer shall ensure that all Evaluation Boards and Reference Boards will be handled in a way which is compliant with the relevant requirements and standards of the country in which they are operated.

The Evaluation Boards and Reference Boards as well as the information provided in this document are addressed only to qualified and skilled technical staff, for laboratory usage, and shall be used and managed according to the terms and conditions set forth in this document and in other related documentation supplied with the respective Evaluation Board or Reference Board.

It is the responsibility of the customer’s technical departments to evaluate the suitability of the Evaluation Boards and Reference Boards for the intended application, and to evaluate the completeness and correctness of the information provided in this document with respect to such application.

The customer is obliged to ensure that the use of the Evaluation Boards and Reference Boards does not cause any harm to persons or third party property.

The Evaluation Boards and Reference Boards and any information in this document is provided "as is" and Infineon Technologies disclaims any warranties, express or implied, including but not limited to warranties of non-infringement of third party rights and implied warranties of fitness for any purpose, or for merchantability.

Infineon Technologies shall not be responsible for any damages resulting from the use of the Evaluation Boards and Reference Boards and/or from any information provided in this document. The customer is obliged to defend, indemnify and hold Infineon Technologies harmless from and against any claims or damages arising out of or resulting from any use thereof.

Infineon Technologies reserves the right to modify this document and/or any information provided herein at any time without further notice.

Safety precautions

Safety precautions

Note: Please note the following warnings regarding the hazards associated with development system

Table 1 Safety precautions





	<p>Warning: The evaluation or reference board contains DC bus capacitors which take time to discharge after removal of the main supply. Before working on the drive system, wait five minutes for capacitors to discharge to safe voltage levels. Failure to do so may result in personal injury or death. Darkened display LEDs are not an indication that capacitors have discharged to safe voltage levels.</p>
	<p>Caution: Only personnel familiar with the drive, power electronics and associated machinery should plan, install, commission and subsequently service the system. Failure to comply may result in personal injury and/or equipment damage.</p>
	<p>Caution: The evaluation or reference board contains parts and assemblies sensitive to electrostatic discharge (ESD). Electrostatic control precautions are required when installing, testing, servicing or repairing the assembly. Component damage may result if ESD control procedures are not followed. If you are not familiar with electrostatic control procedures, refer to the applicable ESD protection handbooks and guidelines.</p>
	<p>Caution: The evaluation or reference board is shipped with packing materials that need to be removed prior to installation. Failure to remove all packing materials that are unnecessary for system installation may result in overheating or abnormal operating conditions.</p>

Table of contents

	About this document	1
	Important notice	2
	Safety precautions	3
	Table of contents	4
1	The board at a glance	5
1.1	Hardware	5
1.2	Block diagram	6
1.3	Main features	6
1.4	Board parameters and technical data	7
2	System and functional description	9
2.1	Getting started	9
2.2	Powering-up the lite kit	10
2.3	Pre-programmed firmware	13
3	Hardware blocks	19
3.1	TRAVEO™ CYT3DL MCU	19
3.2	PSoC™ 5LP (KitProg3)	20
3.3	EZ-USB™ FX3	21
3.4	Power supply block	22
3.5	Program and debug interface	25
3.6	Serial memory interface	27
3.7	Graphics and video interface	29
3.8	HID interface	32
3.9	Crystal oscillator	34
3.10	Reset buttons	34
3.11	Expansion headers	35
3.12	Supported shields	39
4	Programming and debugging	44
4.1	Program CYT3DL device using AutoFlashUtility	44
4.2	Program and debug CYT3DL device using IAR Embedded Workbench	45
4.3	Program and debug CYT3DL device using KitProg3	49
4.4	Program EZ-USB™ FX3	50
5	Technical specifications	55
5.1	Test points	55
5.2	Multiplexed options	56
6	Appendices	57
6.1	Appendix A - Schematics and board design	57
6.2	Bill of material	71
6.3	Pin details	75
	References	80
	Glossary	81
	Revision history	82
	Disclaimer1	83

The board at a glance

1 The board at a glance

The TRAVEO™ T2G Cluster 4M Lite Kit belongs to the TRAVEO™ Cluster 2D graphics family, with the CYT3DL device and on-board EZ-USB™ FX3. This kit is mainly designed to evaluate the functions and features of the CYT3DL series microcontroller. The TRAVEO™ T2G CYT3DL is a family of TRAVEO™ T2G microcontrollers dedicated to automotive systems such as instrument clusters and head-up displays (HUDs).

The TRAVEO™ T2G Cluster 4M Lite Kit includes a TRAVEO™ T2G CYT3DL MCU, an EZ-USB™ FX3, SMIF for interfacing HYPERBUS™ memories (SEMPER™ Flash and HYPERRAM™), and an on-board programmer/debugger such as KitProg3.

This section describes the kit contents, features, block diagram, and the board functions.

1.1 Hardware

This section describes the hardware contents and lists the kit contents.

Table 1 Kit contents

Quantity	Description	Remarks
1	KIT_T2G_C-2D-4M_LITE Rev-B	TRAVEO™ T2G Cluster 2D Family 4M Lite Kit
1	USB Type-C cable	To power up board and stream FX3 output

Note: For streaming TTL RGB packets via the Type-C cable, ensure that it is connected to the USB 3.0 port of the PC.



Figure 1 TRAVEO™ T2G Cluster 4M Lite kit content

Note: There is no quick start guide (QSG) in the box; visit www.infineon.com/traveoc2d4mlitekit for the QSG and other related documents

The board at a glance

1.2 Block diagram

This section shows the TRAVEO™ T2G Cluster 4M Lite block diagram.

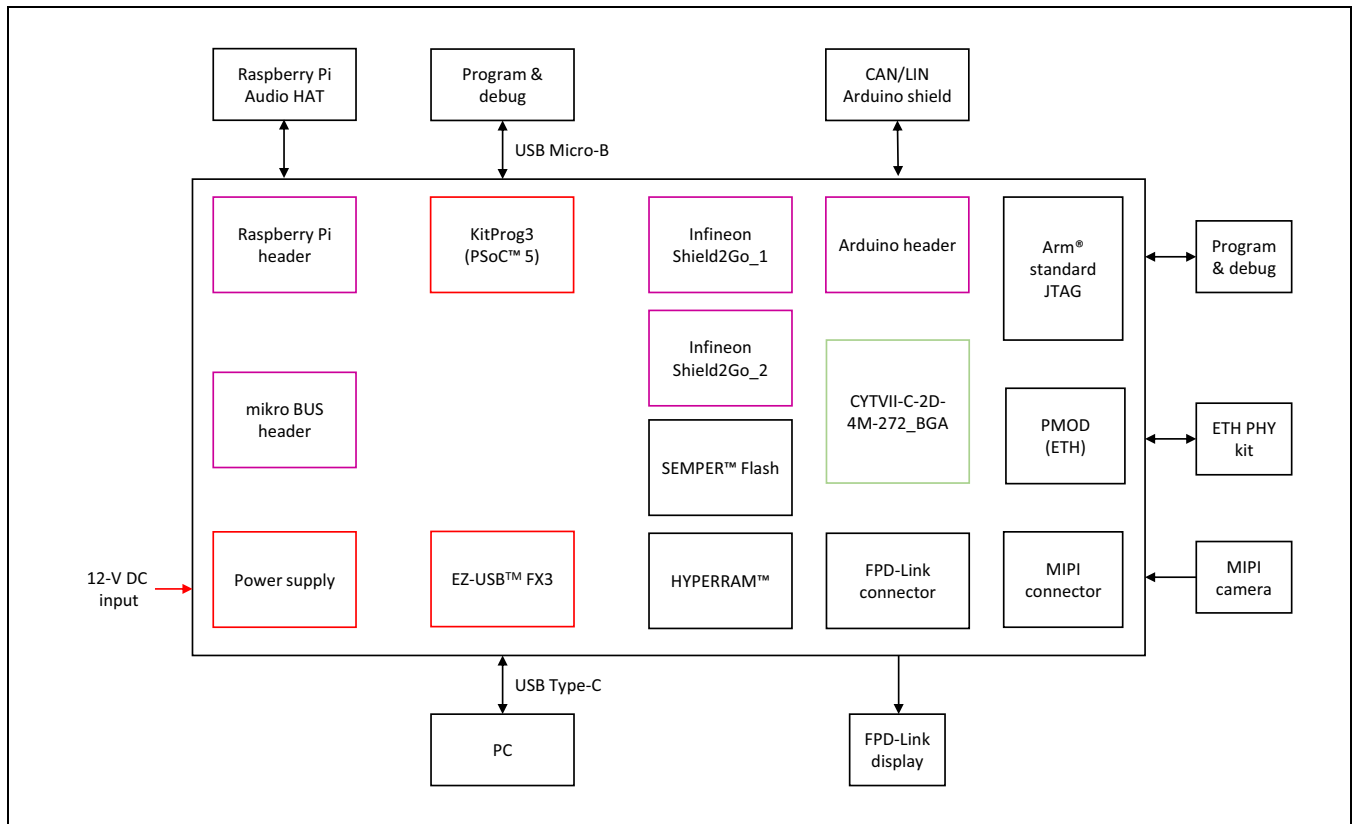

Figure 2 Block diagram

Note: The block diagram contains only the major interfaces; there may be extra blocks between the CYT3DL device and the peripheral component block.

1.3 Main features

- TRAVEO™ T2G CYT3DL device (MCU)
- EZ-USB™ FX3 device
- PSoC™ 5LP (KitProg3) for program and debug
- Crystals
 - 16-MHz external crystal oscillator (ECO)
 - 32.768-kHz watch crystal oscillator (WCO)
- Serial Memory Interface (SMIF)
 - SEMPER™ Flash (S26HL)
 - HYPERRAM™ (S27KL)
- Raspberry Pi compatible I/O header (also compatible with Audio HAT for Audio-codec)
- Arduino-compatible header (also compatible with CY8CKIT-026 for CAN and LIN)
- mikroBUS™ header and Shield2Go footprints
- Single-channel FPD-Link/LVDS interface for up to 1920 x 720 video output
- MIPI-CS12 camera connector
- PMOD connector to support external ethernet PHY (also supports DP83848 Ethernet board)
- Arm® Standard 20-pin JTAG header for program and debug
- Human interface

The board at a glance

- User LEDs
- Push button
- Potentiometer
- USB Type-C connector
 - For powering-up the kit
 - For FX3 output streaming
- USB Micro-B connector
 - For powering-up the kit
 - For KitProg3 USB-UART bridge

1.4 Board parameters and technical data

Table 2 Board functions

Serial no.	Reference designator	Function	Specification
1	U200: BGA-272	TRAVEO™ T2G CYT3DL CPU	CYT3DLBBHBES
2	U500	EZ-USB™ FX3	CYUSB3014-BZXC
3	U400	PSoC™ 5LP KitProg3	CY8C5868LTI-LP039
4	U100	PMIC	IR3883 buck regulator (3.3 V)
5	U105	PMIC	ISL9107IRZ-T buck regulator (1.1 V)
6	U101	LDO	TLS205B0 low dropout voltage regulator (1.2 V)
7	U103	LDO	TLS205B0 low dropout voltage regulator (1.8 V)
8	U104	LDO	TLS205B0 low dropout voltage regulator (2.8 V)
9	X100	Power input	12-V wall adapter (3A)
10	D104	Power LED	3.3-V monitor LED
11	D103	Power LED	1.2-V monitor LED
12	D102	Power LED	1.1-V monitor LED
13	D400	Power LED	USB VBUS monitor LED
14	D401	Status LED	KitProg3 status LED
15	X400	USB connector	USB Micro-B connector
16	X500	USB connector	USB Type-C connector
17	X401	Program connector	2.54-pitch connector for KitProg3
18	X302	ARM20/IAR connector	Arm® Standard-20 pin JTAG connector
19	S200	Reset switch	System reset switch
20	S500	Reset switch	FX3 reset switch
21	X403	Reset jumper	KitProg3 reset jumper

The board at a glance

Table 2 Board functions (continued)

Serial no.	Reference designator	Function	Specification
22	X502	Jumper	EZ-USB™ FX3 bootloader jumper
23	S900	User switch	User push switch connects to DUT
24	D900	User LED	User LED connected to DUT
25	D901	User LED	User LED connected to DUT
26	U600	SEMPER™ flash	S26HL512TPM01
27	U601	HYPERRAM™	S27KL0642DPHA02
28	X801	PMOD connector	Supports external ethernet PHY
29	X701	MIPI-CSI2 interface	Supports MIPI-CSI2 camera
30	X700	FPD-Link interface	Supports FPD-Link display
31	R904	Potentiometer	Resistor based rotary potentiometer
32	Y301	Crystal	16-MHz external crystal oscillator
33	Y300	Crystal	32.768-kHz watch crystal oscillator
34	G700	Crystal	24-MHz oscillator for MIPI camera
35	Y500	Crystal	19.2-MHz oscillator for FX3
36	X802, X803, X805, X806	Arduino Header	1x8 (2), 1x9 (1), 1x10 (1) for Arduino compatibility
37	X800	Raspberry Pi IO header	40-pin I/O header Raspberry Pi compatible
38	X812, X813	mikroBUS header	1x8 (2) for mikroBUS™ compatibility
39	S800, S801	Shield2Go header	2 Shield2Go compatible footprints

System and functional description

2 System and functional description

This section explains how to set up and power up the TRAVEO™ T2G Cluster 4M Lite kit, and how to run the pre-programmed firmware.

2.1 Getting started

2.1.1 Initial setup and default jumper connection

This section describes the default jumper configuration and location required for each module. Since some interfaces are multiplexed, the default interface selection is mentioned in the following table.

This initial configuration also helps to generate all the power supplies from the PMIC and distribute them to safely power-up the CYT3DL device.

Table 3 lists all the default jumper configurations.

Table 3 Jumper configurations

Jumper	Function	Position: selection
X101	3.3-V PMIC	1-2: short (default)
		1-2: open
X102	1.1-V PMIC	1-2: short (default)
		1-2: open
X103	12-V VIN selected	1-2: short
	5-V VIN selected	2-3: short (default)
X104	12-V input	1-2: open
	5-V input	1-2: short (default)
X200	VDDA selected to 3.3 V	1-2: short (default)
	VDDA selected to 5 V	2-3: short
X201	VDDIO selected to 3.3 V	1-2: short (default)
	VDDIO selected to 5 V	2-3: short
X300	KitProg RX	1-2: short (default)
	mikroBUS SPI CLK	2-3: short
X301	KitProg TX	1-2: short (default)
	mikroBUS SPI MOSI	2-3: short
X403	KitProg3 will not get reset	1-2: open (default)
	KitProg3 will get reset	1-2: short
X502	FX3 not going into bootloader	1-2: open (default)
	FX3 will going into bootloader	1-2: short
X804	VIN for Arduino header	1-2: short (default)
	VIN for Arduino header	1-2: open

System and functional description

Table 3 Jumper configurations (continued)

Jumper	Function	Position: selection
X808	3.3 V for RPi header	1-2: short (default)
	No 3.3 V to RPi header	1-2: open
X809	TDM RX FSYNC going to RPi header	1-2: short
	TDM RX FSYNC to TX FSYNC	2-3: short (default)
X810	TDM RX MCLK going to RPi header	1-2: short
	TDM RX MCLK to TX MCLK	2-3: short (default)
X811	TDM RX SCK routed to RPi header	1-2: short
	TDM RX SCK to TX SCK	2-3: short (default)

2.2 Powering-up the lite kit

The TRAVEO™ T2G Cluster 4M Lite kit can be powered through any of these three options:

- USB type-C (default powering option)
- 12-V DC power adapter
- USB micro-B (KitProg3 also gets powered-up here)

2.2.1 USB Type-C

Change the jumper positions as follows (highlighted with a yellow box in [Figure 3](#)):

- X103 - short 2-3
- X104 - short.

Now, connect the Type-C cable between the USB Type-C connector X500 and the USB Type-C port of the laptop/PC. Once this jumper configuration is done, observe that the power LEDs (3.3 V, 1.2 V, and 1.1 V) start glowing.

[Figure 3](#) shows the connection of the USB Type-C cable and jumper configuration.

System and functional description

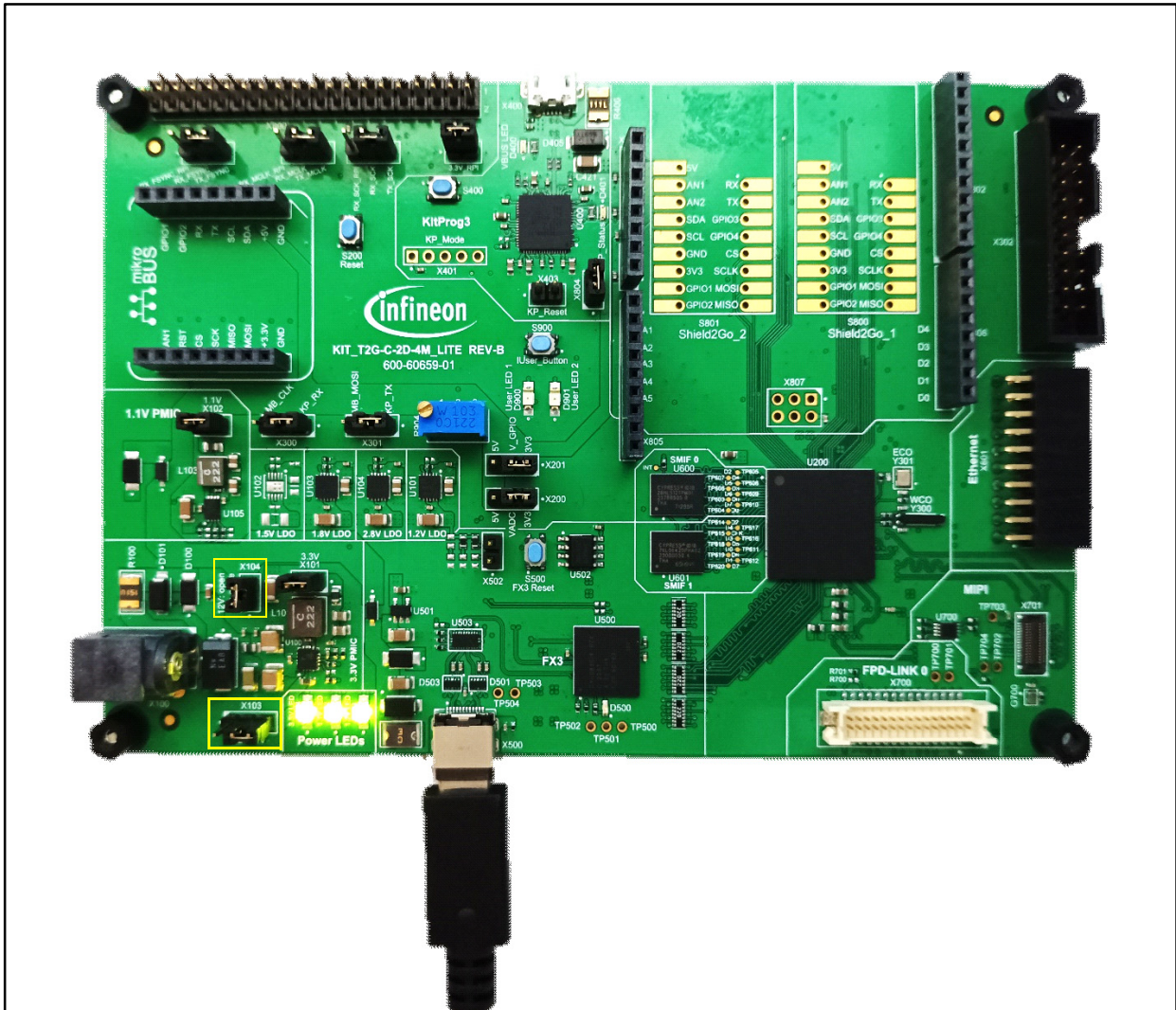

Figure 3 Connecting the USB Type-C between X500 and USB port of laptop

2.2.2 12-V DC power adapter

Change the jumper positions as follows (highlighted with a yellow box in Figure 4):

- X103 - shorted 1-2
- X104 - open.
- Connect the 12-V DC power adapter of output 12 V/3 A to the 12-V DC power jack X100 on the kit. Observe that the green power LEDs (3.3 V, 1.2 V, and 1.1 V) start glowing after power-up.

System and functional description

Figure 4 shows the connection of the 12-V power adapter and jumper configuration.

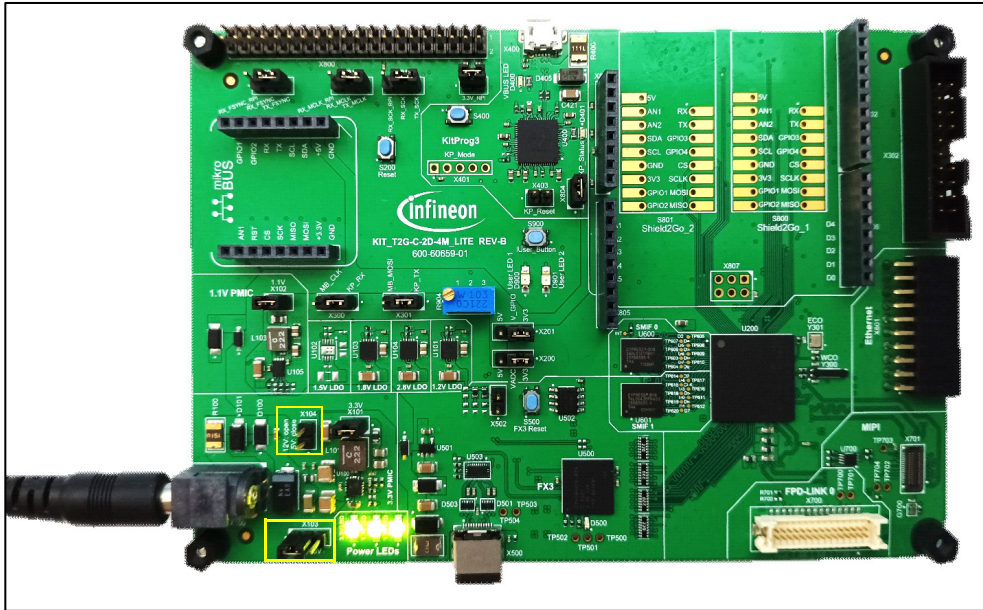

Figure 4 Connecting 12-V DC power adapter to X100

2.2.3 USB Micro-B

Use the same jumper settings as mentioned in the USB Type-C section. After configuring the jumper settings, connect the USB Micro-B cable between the USB Micro-B connector X400 and the USB port of the PC.

Observe that the VBUS LED (5 V) and power LEDs (3.3 V, 1.2 V, and 1.1 V) start glowing. The KitProg3 mode status LED (D401) also glows because KitProg3 gets powered-up with this Micro-B cable.

Figure 5 shows the connection of the USB Micro-B cable and jumper configuration.

System and functional description

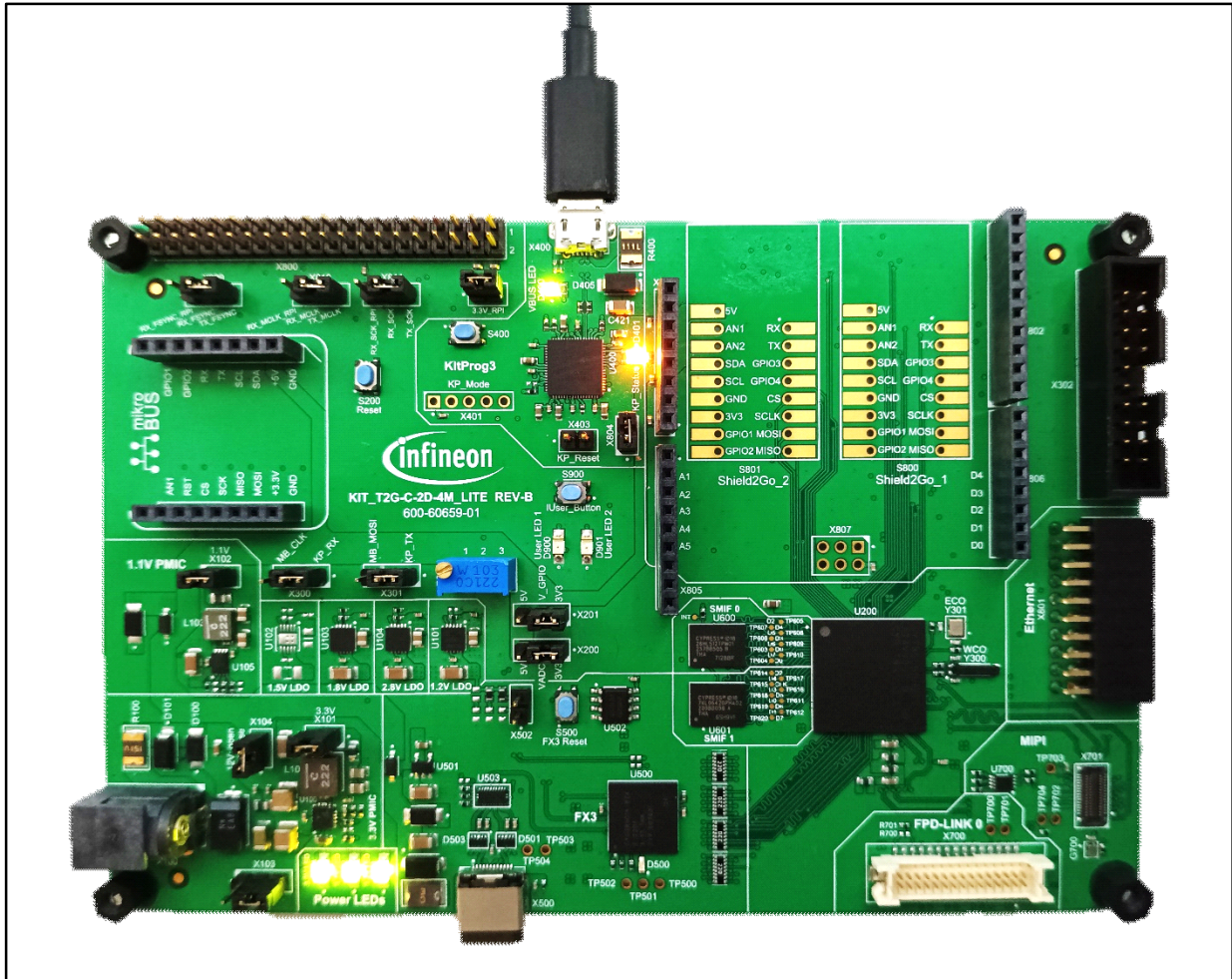

Figure 5 Connecting Micro-B cable between X400 and USB port of laptop

Note: In this option, the PSoC™ 5LP (KitProg3) is also powered up, which is not possible in other powering options. If the KitProg3 mode status LED (D401) is glowing, then PSoC™ 5LP (KitProg3) is powered up.

2.3 Pre-programmed firmware

The TRAVEO™ T2G Cluster 4M Lite kit is tested and shipped with preloaded software and starts executing once the kit is powered up. The kit has pre-programmed software with full test logs and FX3 IRIS pattern firmware. After powering up the device and checking the initial jumper positions, refer to the procedure mentioned in the following sections to see the full test log firmware and FX3 IRIS pattern firmware.

System and functional description

2.3.1 Full test log

Follow this procedure to see the test logs in the serial terminal window:

- 1. Open Tera Term (or any serial terminal software) in your PC.

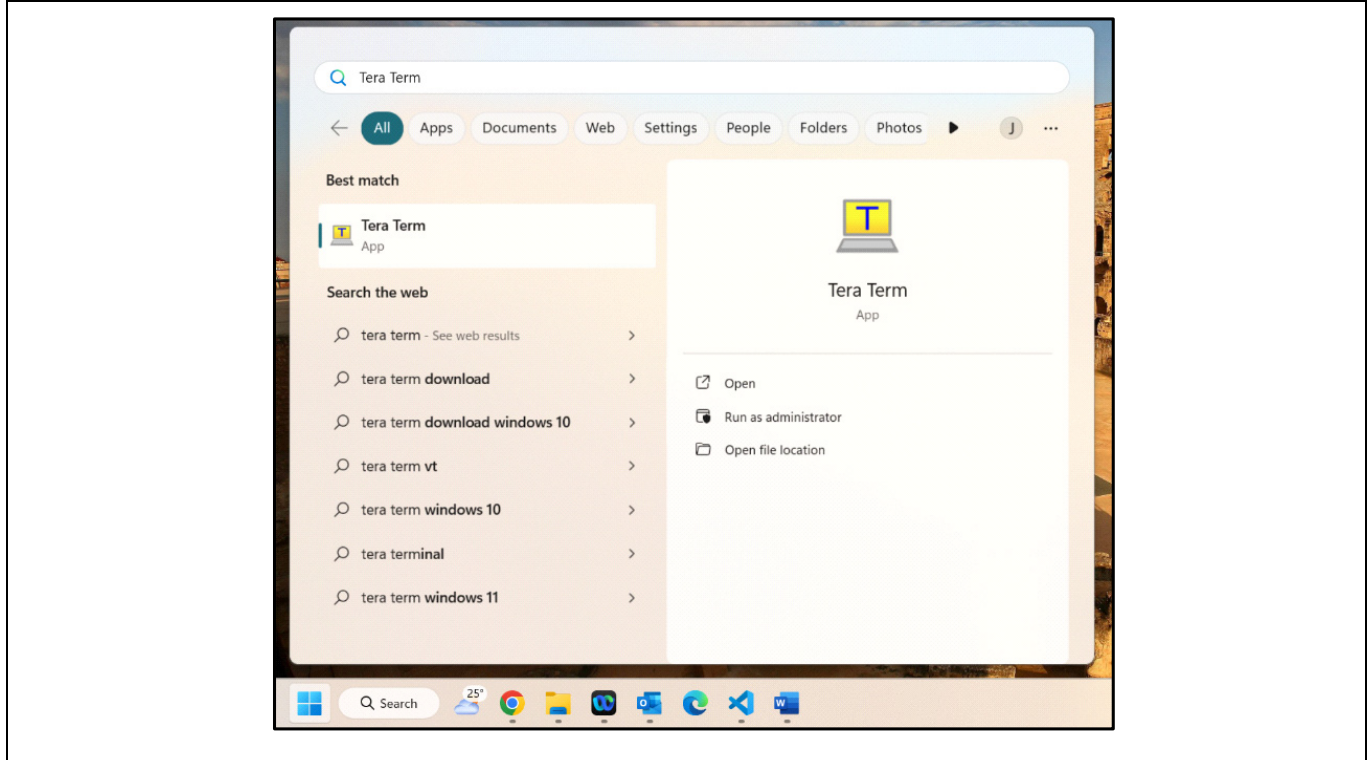

Figure 6 Opening serial terminal in PC

- 2. Select connection as "Serial" and then in the "Port" option, select the port that shows "KitProg3 USB-UART".

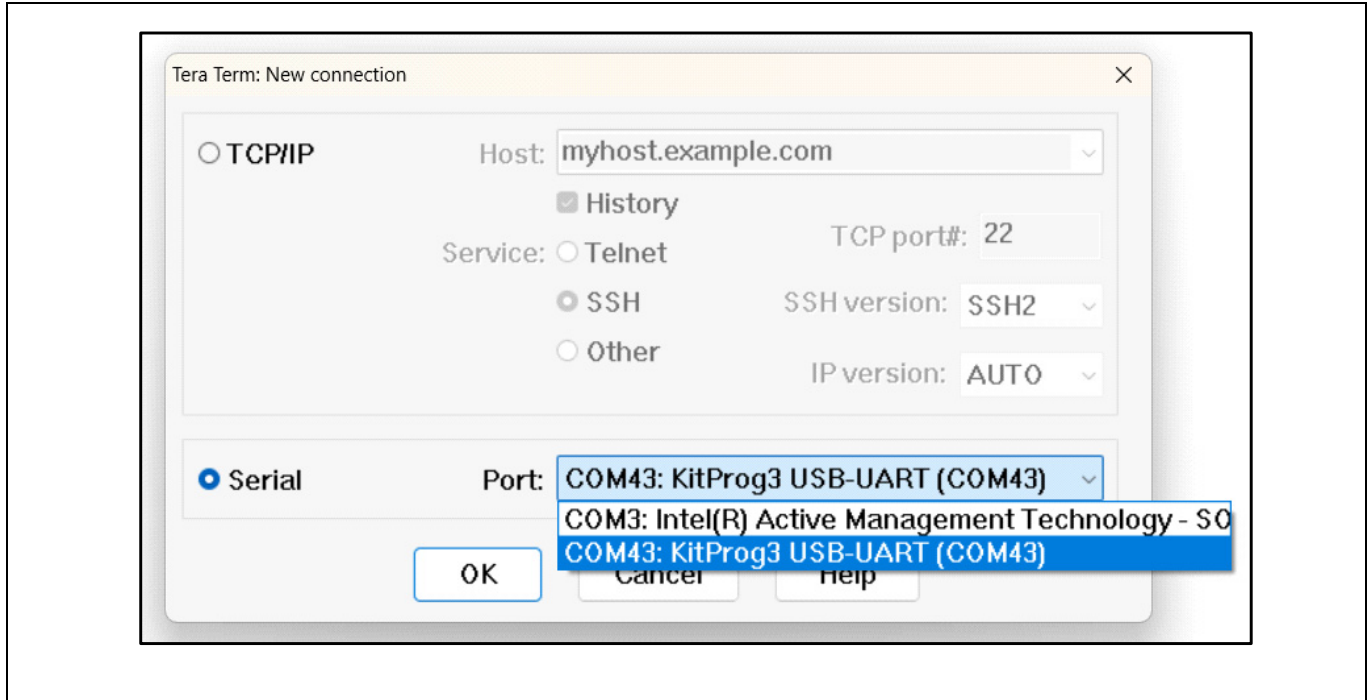

Figure 7 Selecting KitProg3 USB-UART port

System and functional description

3. Next, go to **Setup > Serial port > Speed >** and select "115200" and press the "New setting" button.

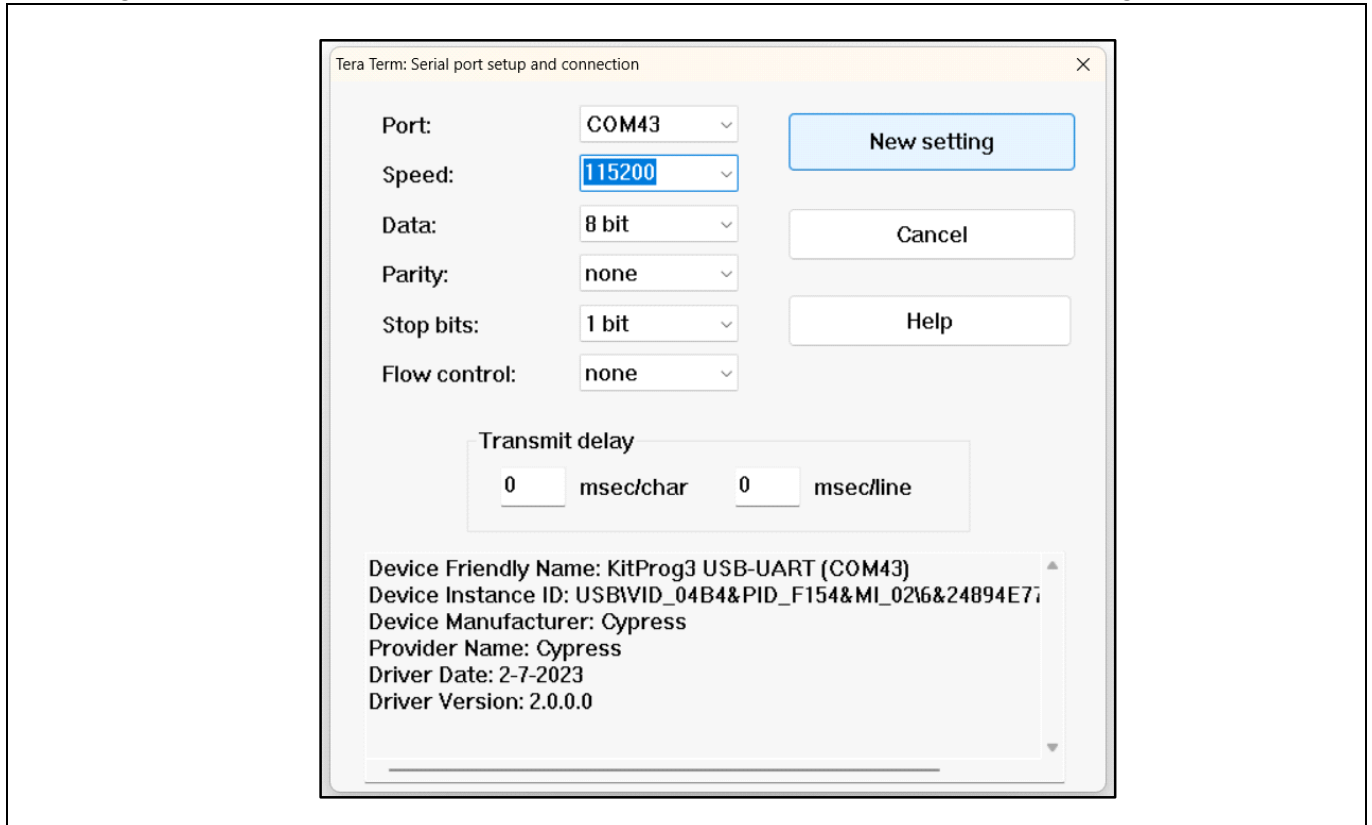

Figure 8 Selecting baud-rate of UART in terminal

4. Now, press the reset button (S200) on the kit and the message logs (silicon details and test results of peripherals) pop up on the screen, as shown in the following screenshot.

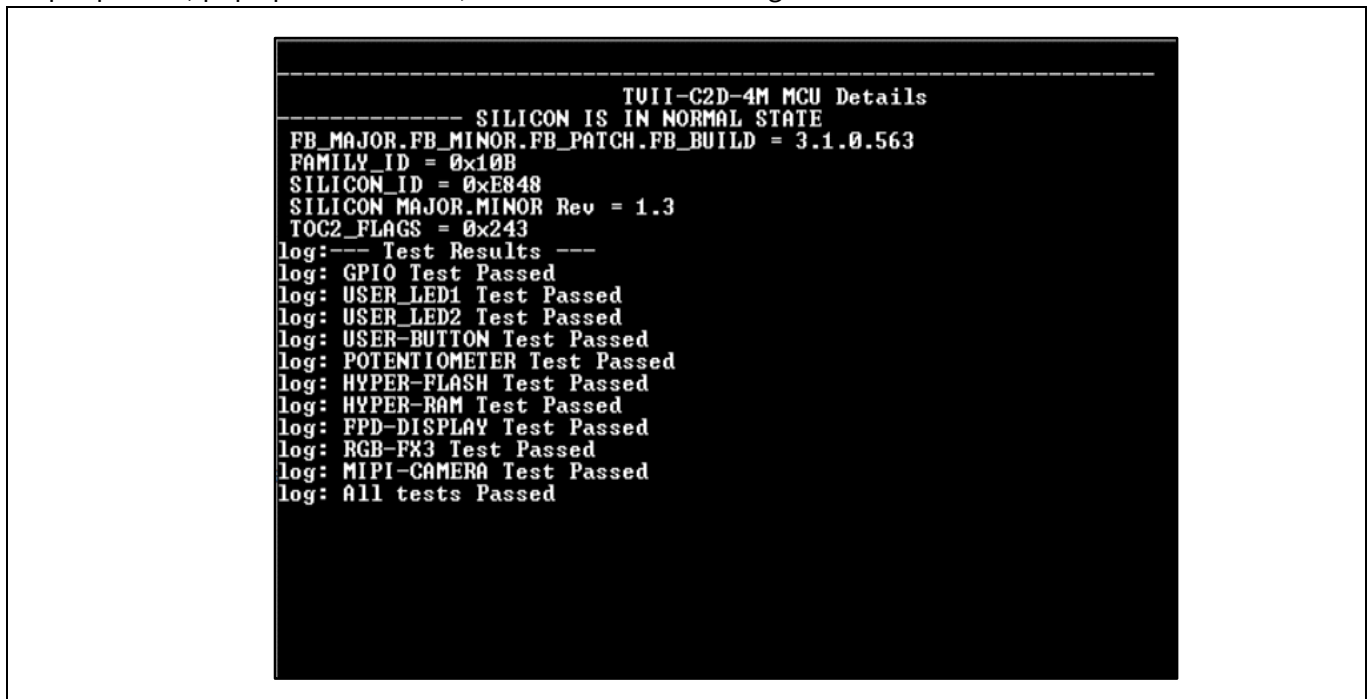

Figure 9 Silicon details and test logs

System and functional description

2.3.2 EZ-USB™ FX3 IRIS pattern

Follow this procedure to see the IRIS pattern in the VLC media player (or any media player):

1. First, ensure that jumper X502 (highlighted in the yellow box in Figure 10) is not shorted. If it is shorted, then remove that jumper, and disconnect and reconnect the power supply.

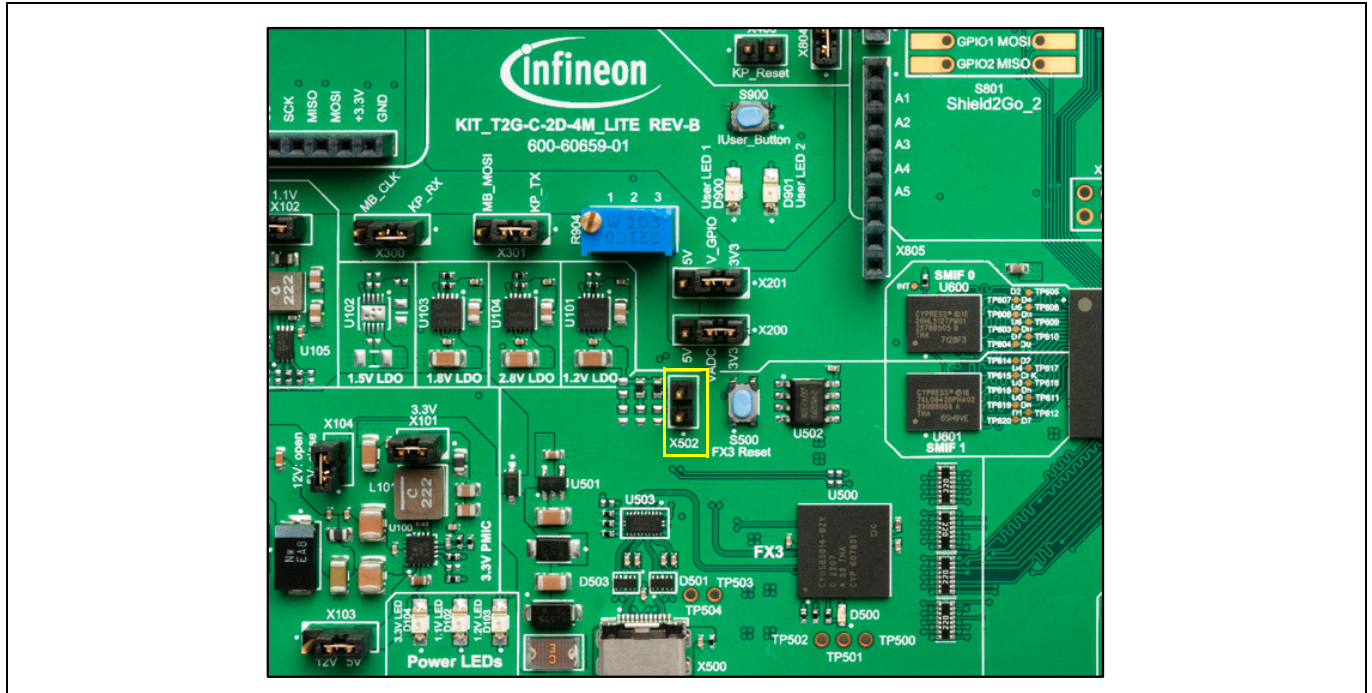

Figure 10 Checking FX3 bootloader jumper on the kit

2. Next, connect the Type-C cable (which is part of the kit content) between jumper X500 and the laptop/PC USB 3.0 Type-C port (FX3 supports only USB 3.0 ports).

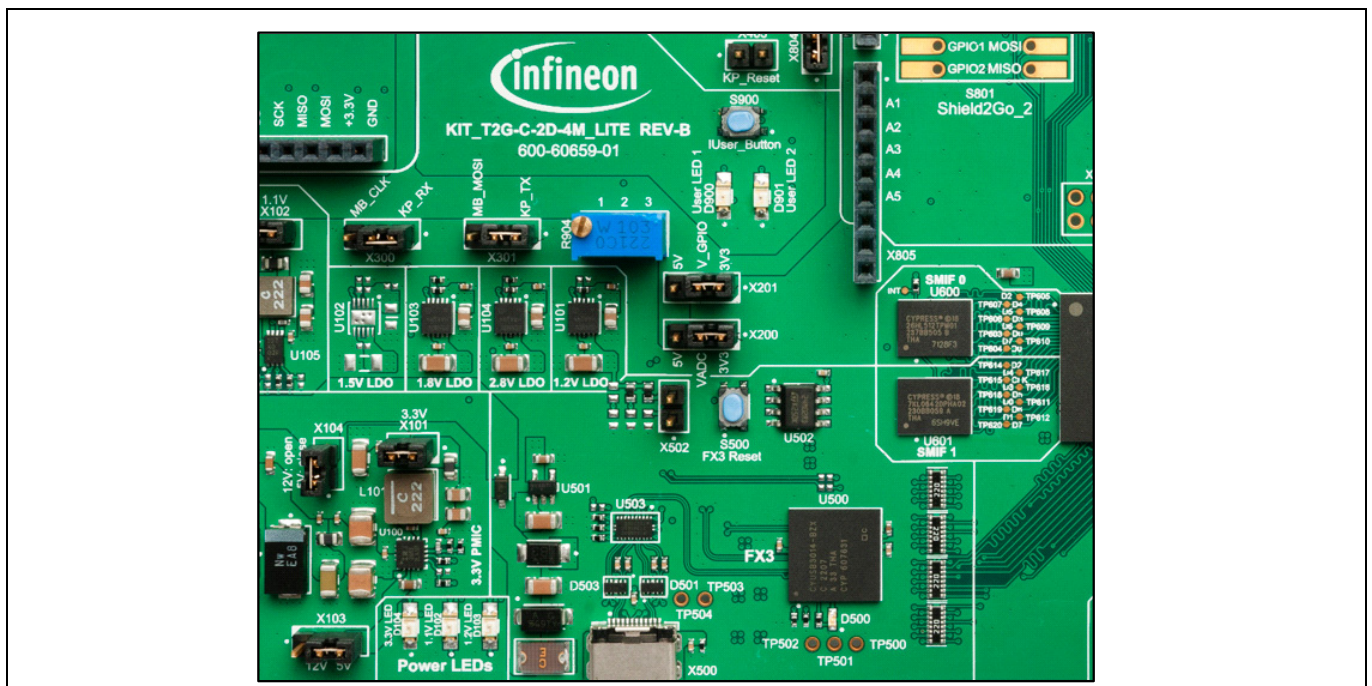

Figure 11 Connecting Type-C between X500 and laptop USB 3.0 port

System and functional description

3. Open the VLC media player and go to Media/ Open Capture Device.

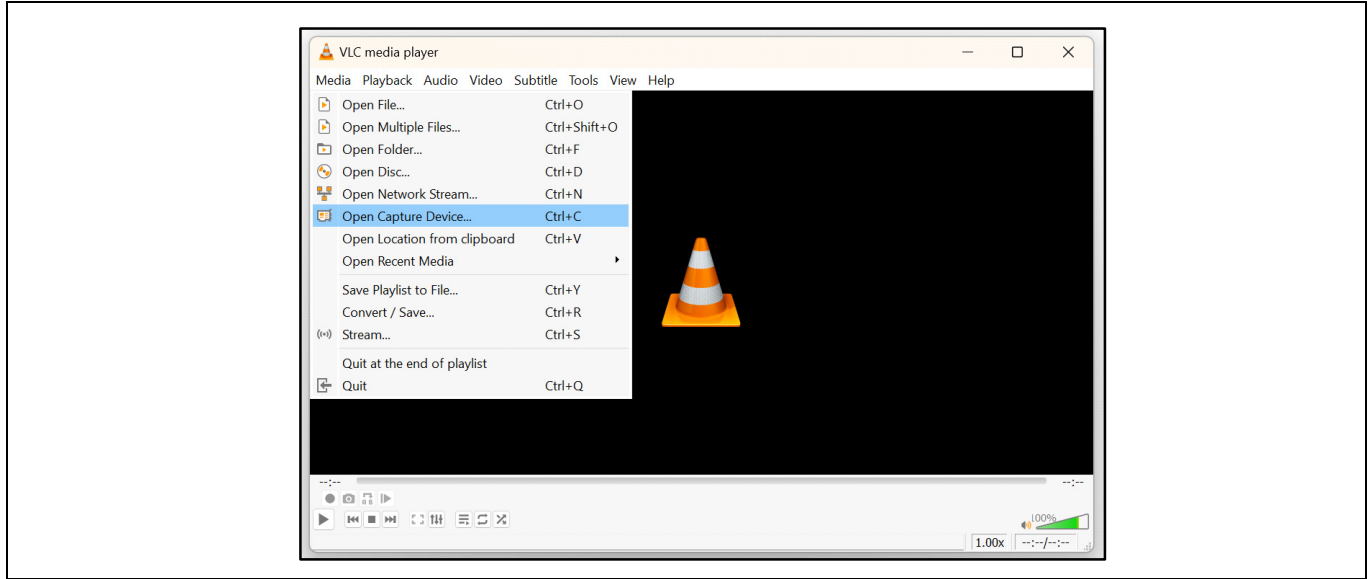

Figure 12 VLC media player window

4. In the Capture Device tab, enter the following settings:

- Capture mode : DirectShow
- Video device name : FX3
- Audio device name : Default
- Video size : 800x480

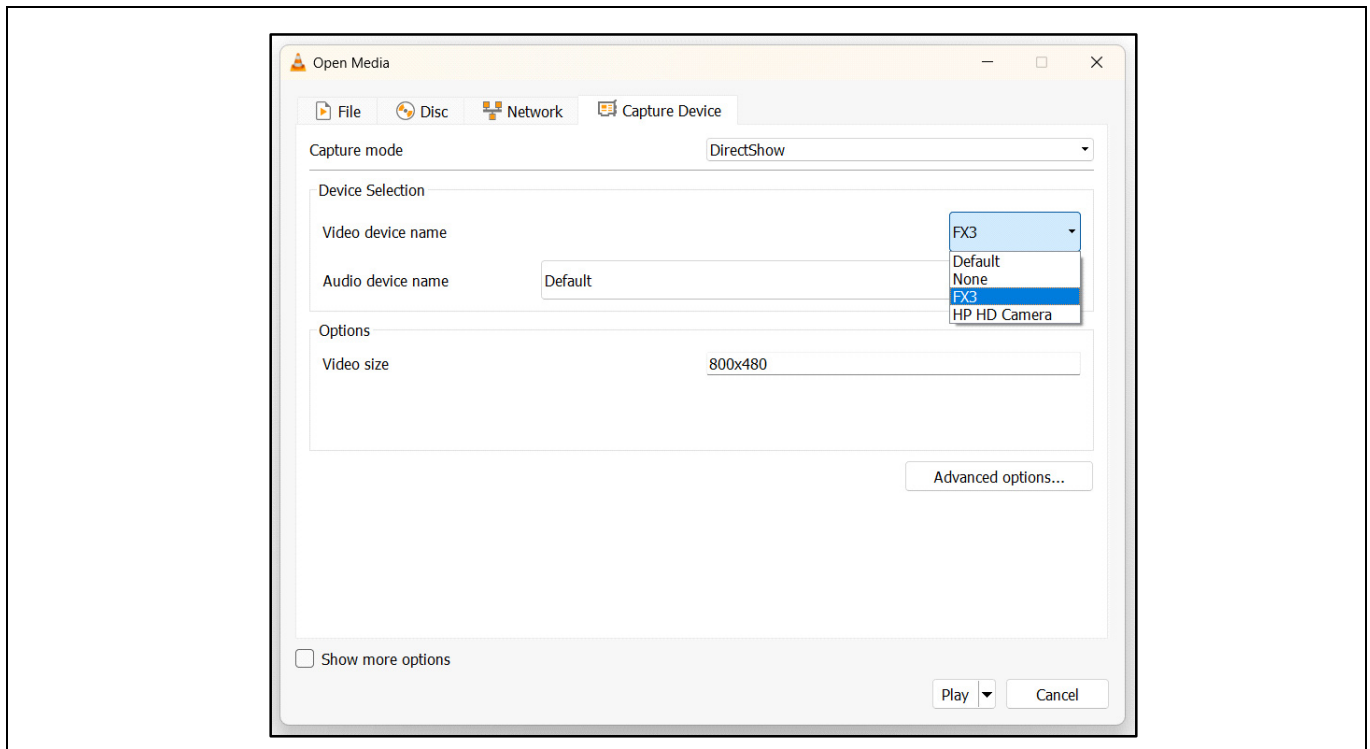

Figure 13 FX3 settings in VLC media player

System and functional description

5. Click on the Play button and note the IRIS pattern in the VLC media player window.

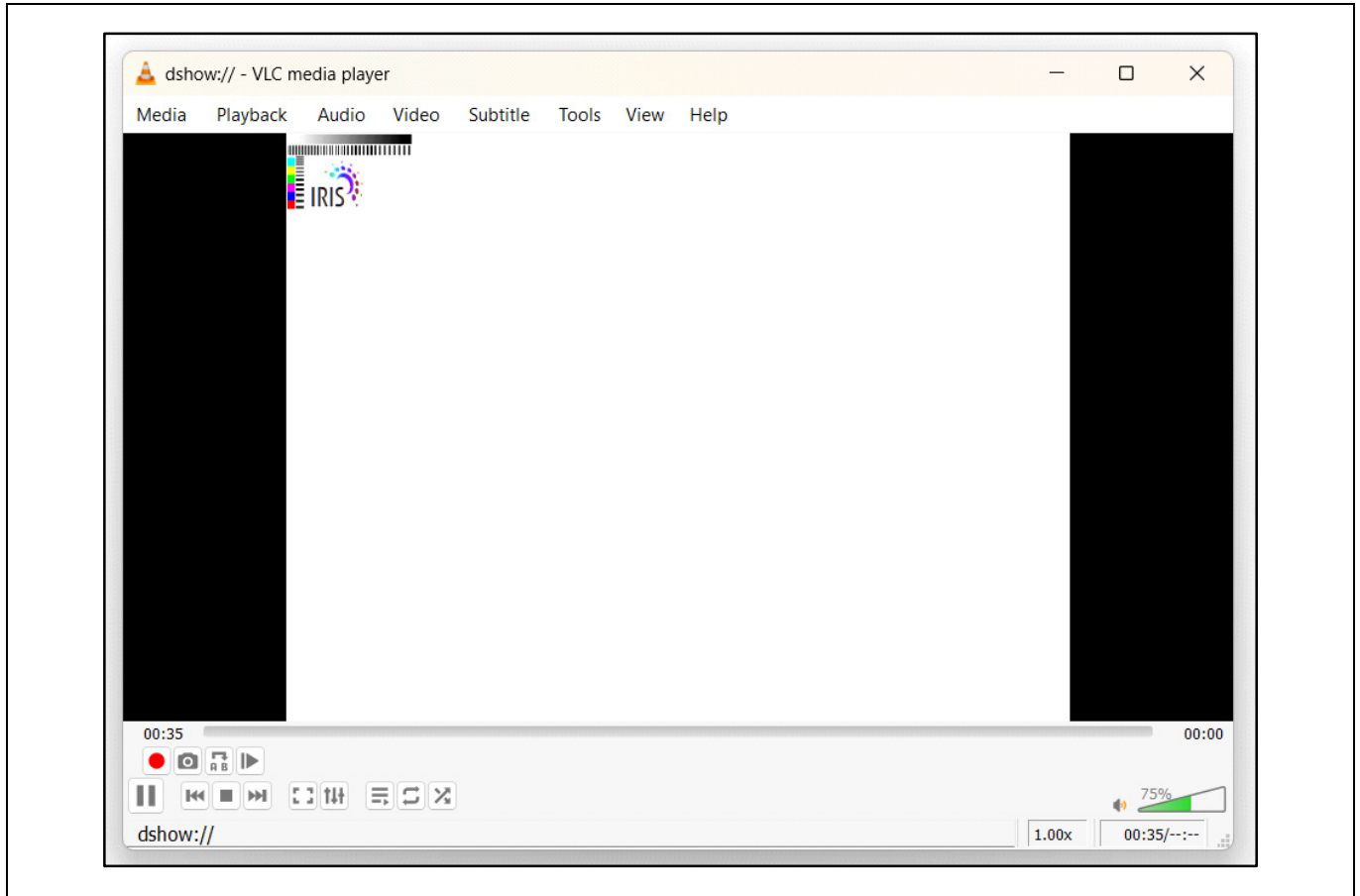

Figure 14 IRIS pattern coming on screen via FX3

Hardware blocks

3 Hardware blocks

This section describes the major hardware blocks of the TRAVEO™ T2G Cluster 4M Lite kit.

3.1 TRAVEO™ CYT3DL MCU

The TRAVEO™ T2G Cluster 4M Lite kit is designed to evaluate the different features and functionality of the TRAVEO™ T2G CYT3DL device.

CYT3DL is a family of TRAVEO™ T2G microcontrollers dedicated to automotive systems such as instrument clusters and HUDs. This family features a 2D Graphic engine, sound processing, an Arm® Cortex®-M7 CPU running up to 240 MHz for primary processing, and an Arm® Cortex®-M0+ CPU for peripheral and security processing. The CYT3DL comes in two unique packages: 216-pin TEQFP and the 272-ball BGA. The TRAVEO™ T2G Cluster 4M Lite kit uses the 272-ball BGA package.

Figure 15 shows the block diagram of the TRAVEO™ T2G CYT3DL MCU.

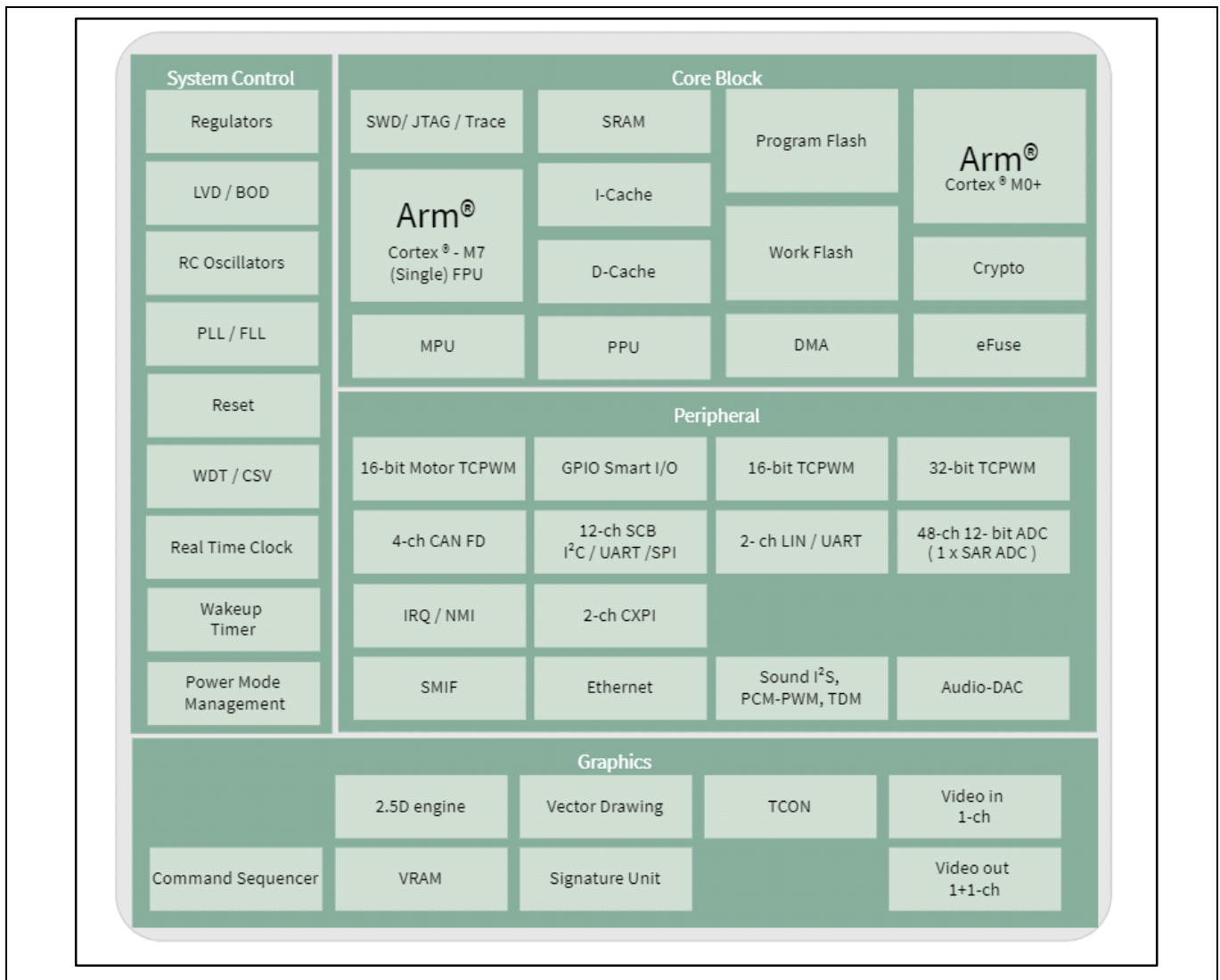

Figure 15 TRAVEO™ T2G CYT3DL block diagram

Hardware blocks

Table 4 shows the MCU device description.

Table 4 MCU device description

Reference	Manufacturer	Part number	Package, size
U200	Infineon Technologies	CYT3DLBBHBES	272- Ball BGA

Figure 16 shows the location of the CYT3DL device (MCU) in this kit.

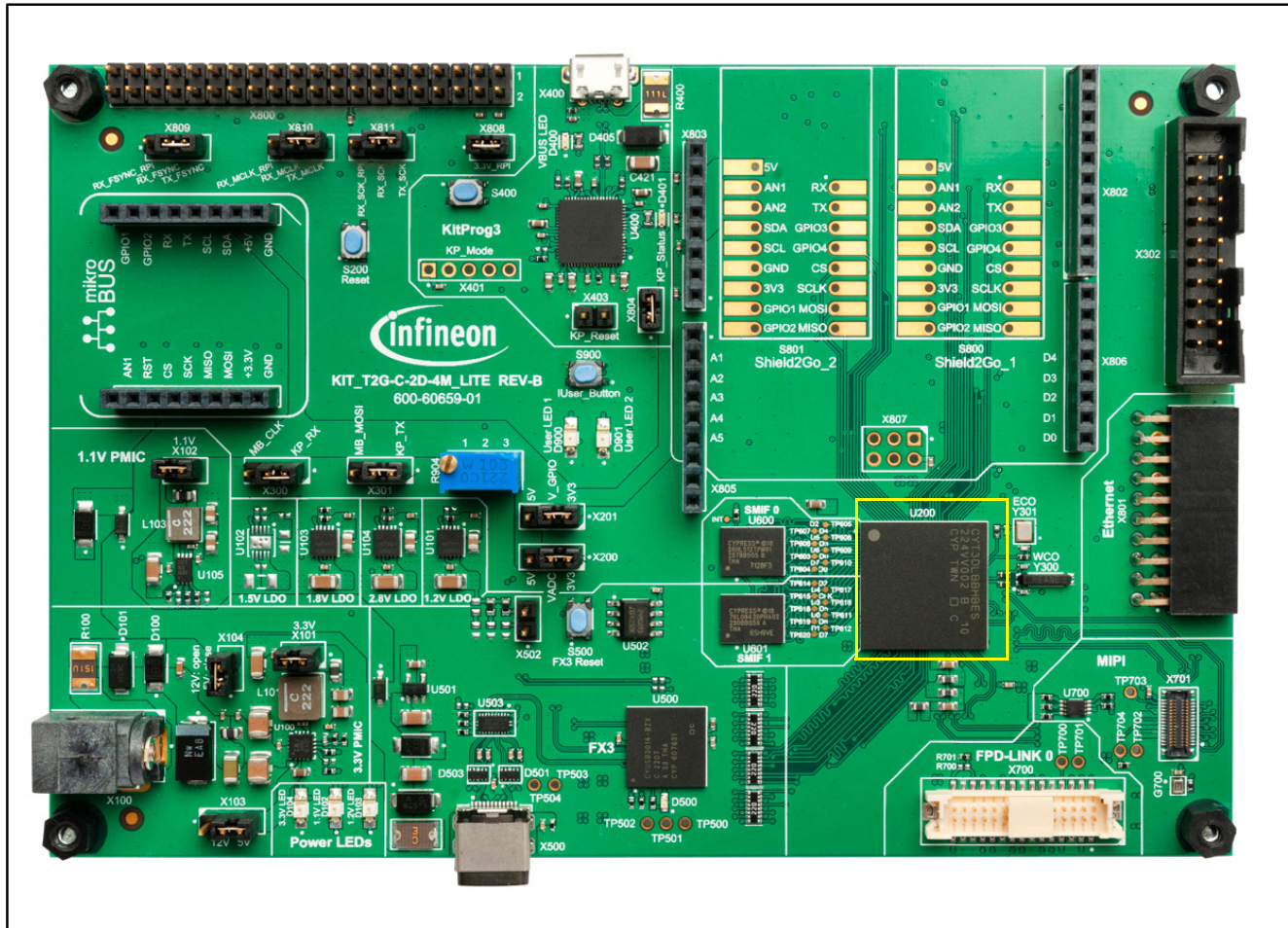

Figure 16 CYT3DL device location

3.2 PSoC™ 5LP (KitProg3)

PSoC™ 5LP is a true programmable embedded system-on-chip, integrating configurable analog and digital peripherals, memory, and a microcontroller on a single chip while the KitProg3 is low-level communication firmware for programming and debugging. It provides communication between a programming tool (such as the CYPRESS™ Programmer or PSoC™ Programmer) and a target, such as the PSoC™ 5LP. KitProg3 supports a variety of development kits.

KitProg3 uses industry-standard Serial Wire Debug (SWD) and JTAG protocols, such as CMSIS-DAP V2.0.0 and V1.2.0 as the Bulk and HID endpoint transport mechanisms. KitProg3 implements USB Bulk endpoints for faster communication. It also supports HID endpoints for use cases that require them, but communication is slower.

KitProg3 also supports the following bridges: USB-UART, USB-I2C, USB-SPI, and GPIO. In this kit, the KitProg3 is already configured to be used as a USB-UART bridge to program and debug the CYT3DL device.

Figure 17 shows the location of PSoC™ 5LP (KitProg3) in this kit.

Hardware blocks

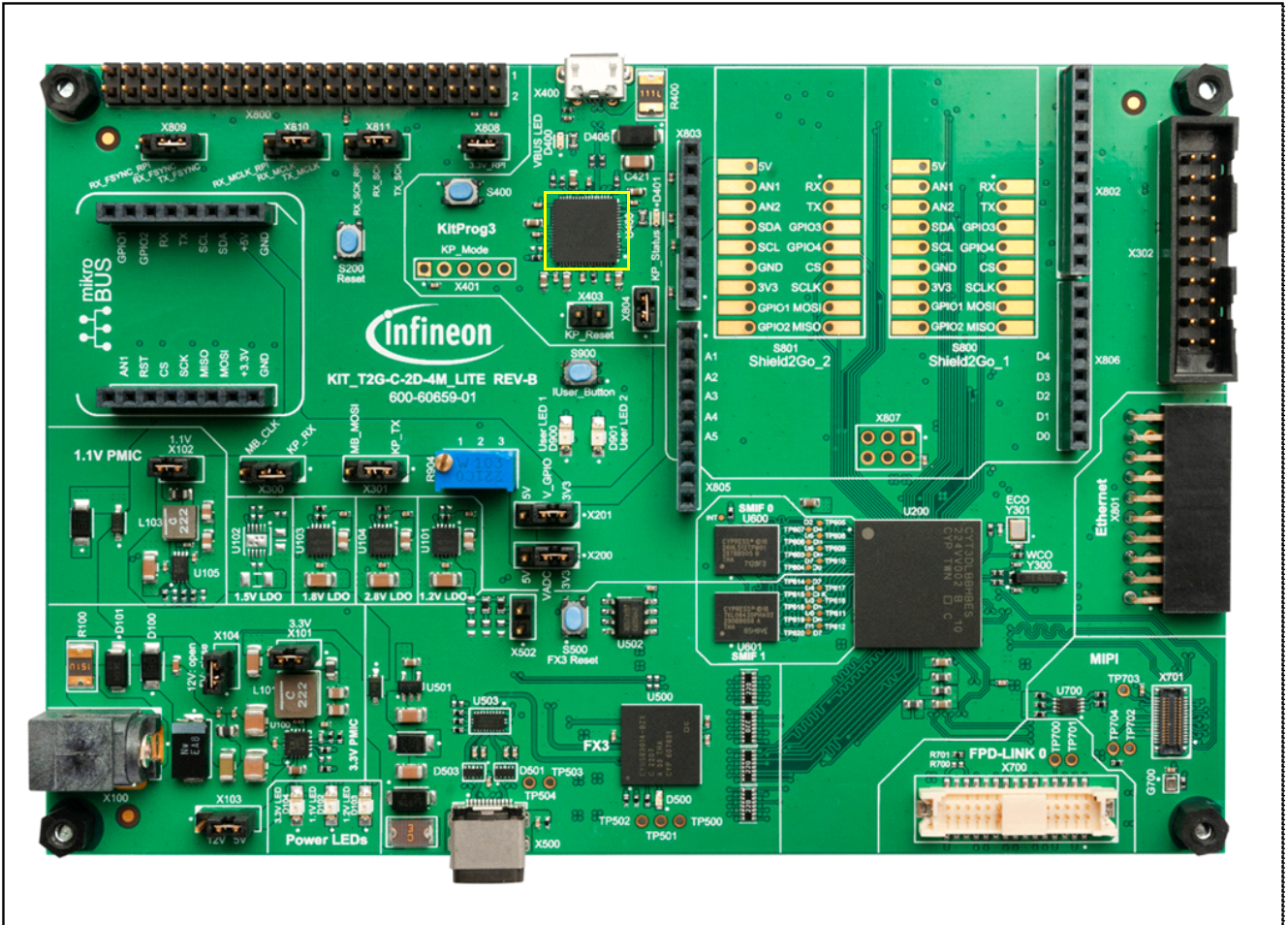

Figure 17 KitProg3 location

3.3 EZ-USB™ FX3

Infineon's EZ-USB™ FX3 is the industry's most versatile USB peripheral controller, which can add a USB 5-Gbps connectivity to any system. The second-generation general programmable interface (GPIF II) of EZ-USB™ FX3 can connect to a processor, an image sensor, an FPGA, or an ASIC. Users can program the GPIF to behave like a FIFO, an asynchronous SRAM, an address/data multiplexed interface, a CompactFlash, or a proprietary interface.

In this kit, you can connect the EZ-USB™ FX3 that has a Type-C connector directly to the laptop/PC USB port (note that EZ-USB™ FX3 only supports the USB 3.0 port) for streaming graphics output. You do not need any RGB display to view the graphics output.

Figure 18 shows the location of the EZ-USB™ FX3 in this kit.

Hardware blocks

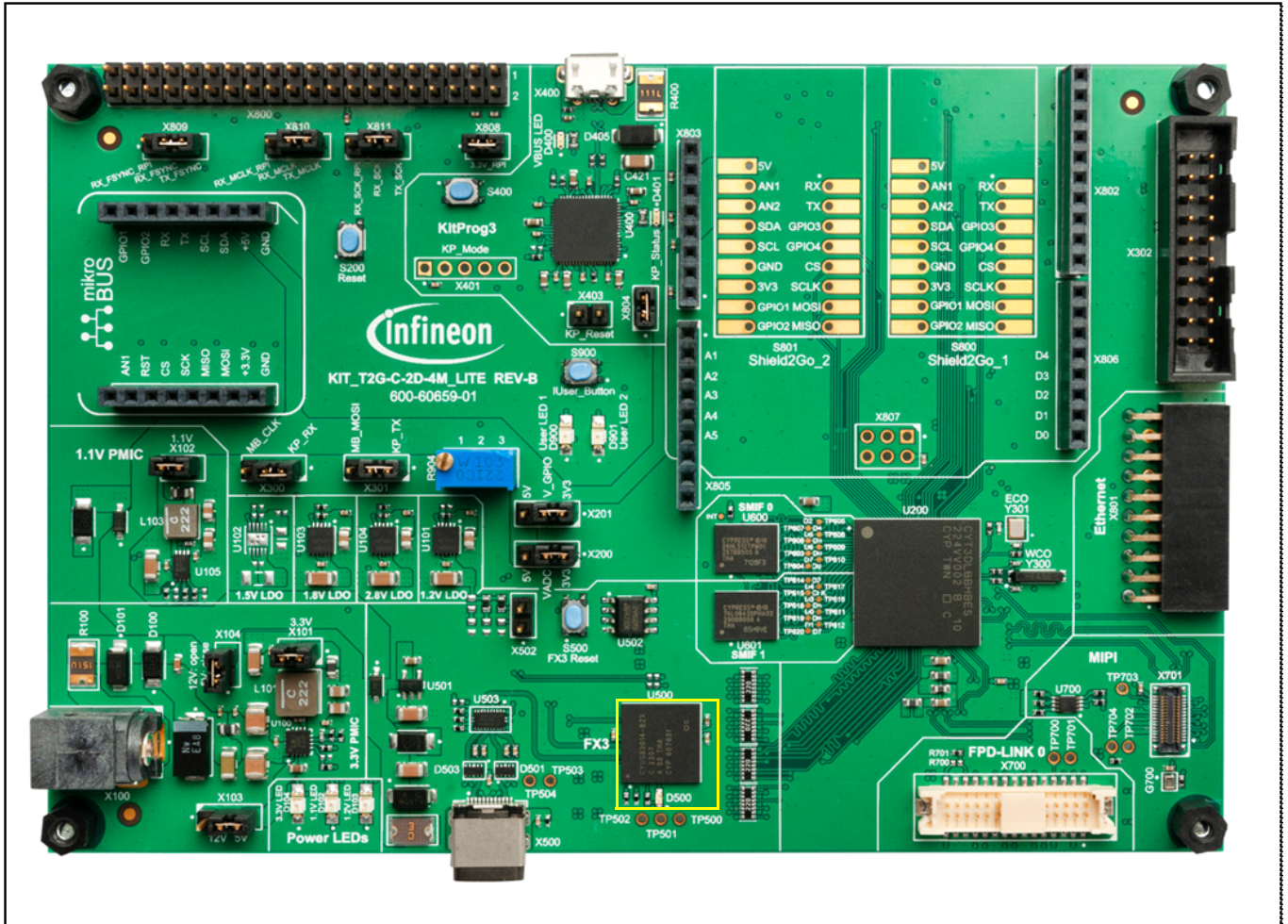

Figure 18 EZ-USB™ FX3 location

Note: Refer to [Section 3.7.1](#).

3.4 Power supply block

This kit supports the on-board PMIC module and LDOs to generate the power supplies to run the TRAVEO™ T2G CYT3DL MCU and other peripherals. The PMIC module takes input from the 12-V adapter or 5 V from the USB connectors to generate voltages based on the requirements and configurations for this kit. The PMIC output rails can drive the other peripherals available on the kit.

[Figure 19](#) illustrates the kit power supply block diagram.

Hardware blocks

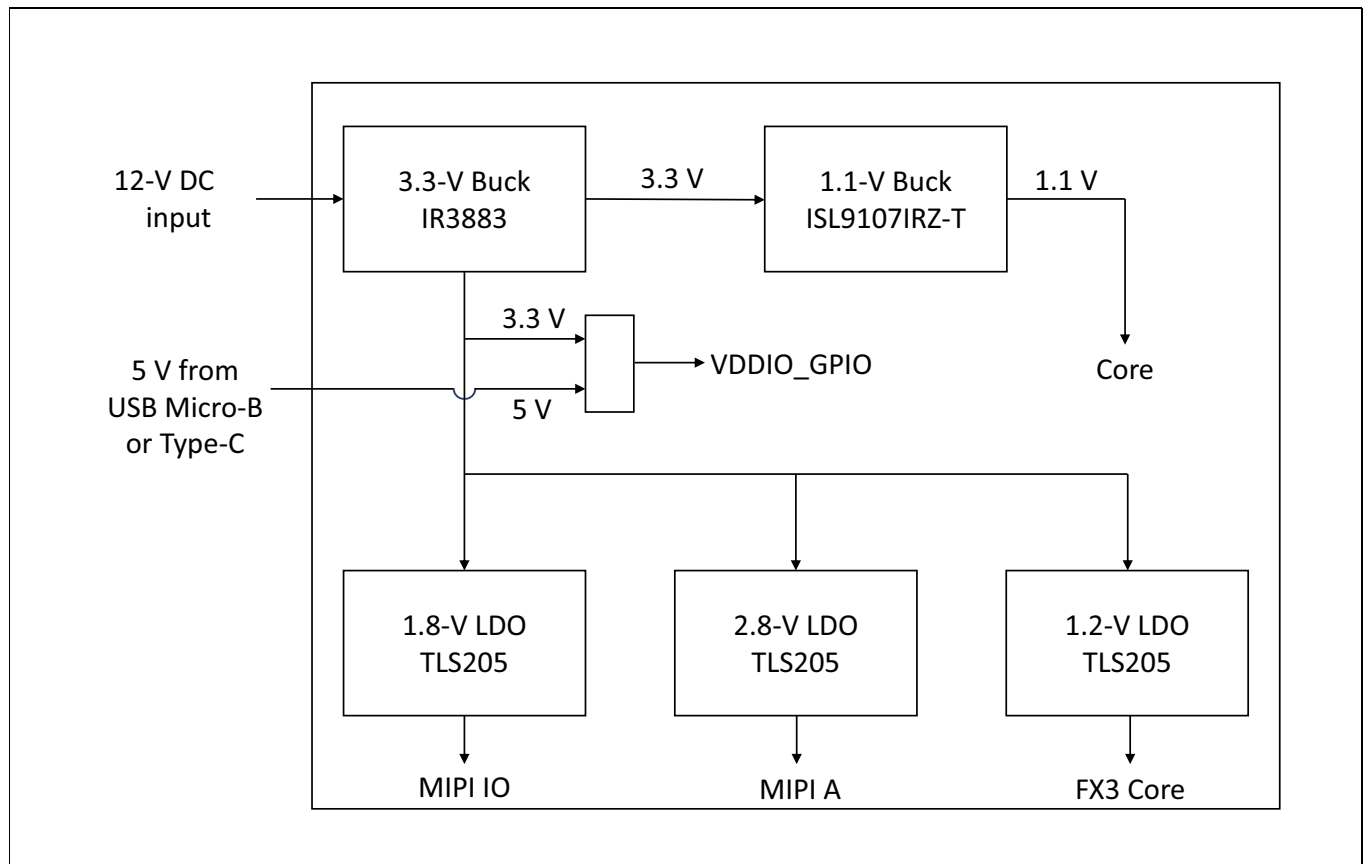

Figure 19 Block diagram of power supply

Hardware blocks

The following figure explains the operation of 12 V and 5 V with VIN ORED connection of the TRAVEO™ T2G Cluster 4M Lite Kit.

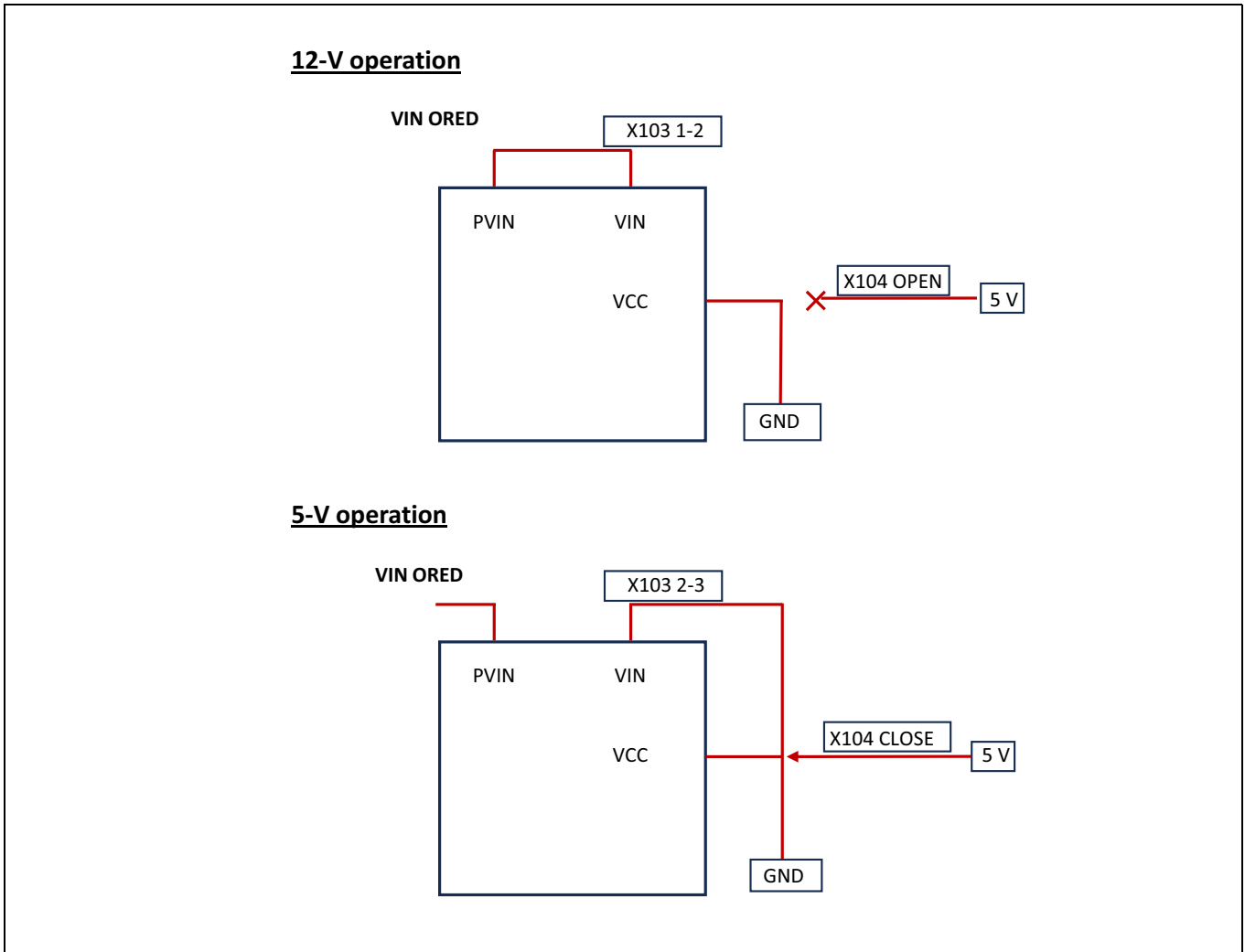

Figure 20 Power operation block diagram

For the 12-V powering option, connect the jumpers as follows:

- X103 - shorted between 1 and 2
- X104 - open

For the 5-V powering option, connect the jumpers as follows:

- X103 - shorted between 2 and 3
- X104 - close

In this kit, the IR3883 buck regulator is used for 12-V DC to 3.3-V DC conversion and the ISL9107IRZ-T buck regulator is used for 3.3-V to 1.1-V DC conversion. The primary supply comes from the IR3883 buck regulator, which converts the 12-V DC to 3.3-V DC.

This kit has other power LDOs to generate the power supply for other peripherals. The board generates 1.8-V, 2.8-V, and 1.2-V voltage rails for different peripherals such as Ethernet, MIPI-CSI2, and FPD-Link display.

In this kit, the TLS205B0 adjustable version low dropout voltage regulator is used for generating power supplies of 1.2 V, 1.8 V, and 2.8 V.

Figure 21 shows the location of different PMICs and LDOs in the TRAVEO™ T2G Cluster 4M Lite kit.

Hardware blocks

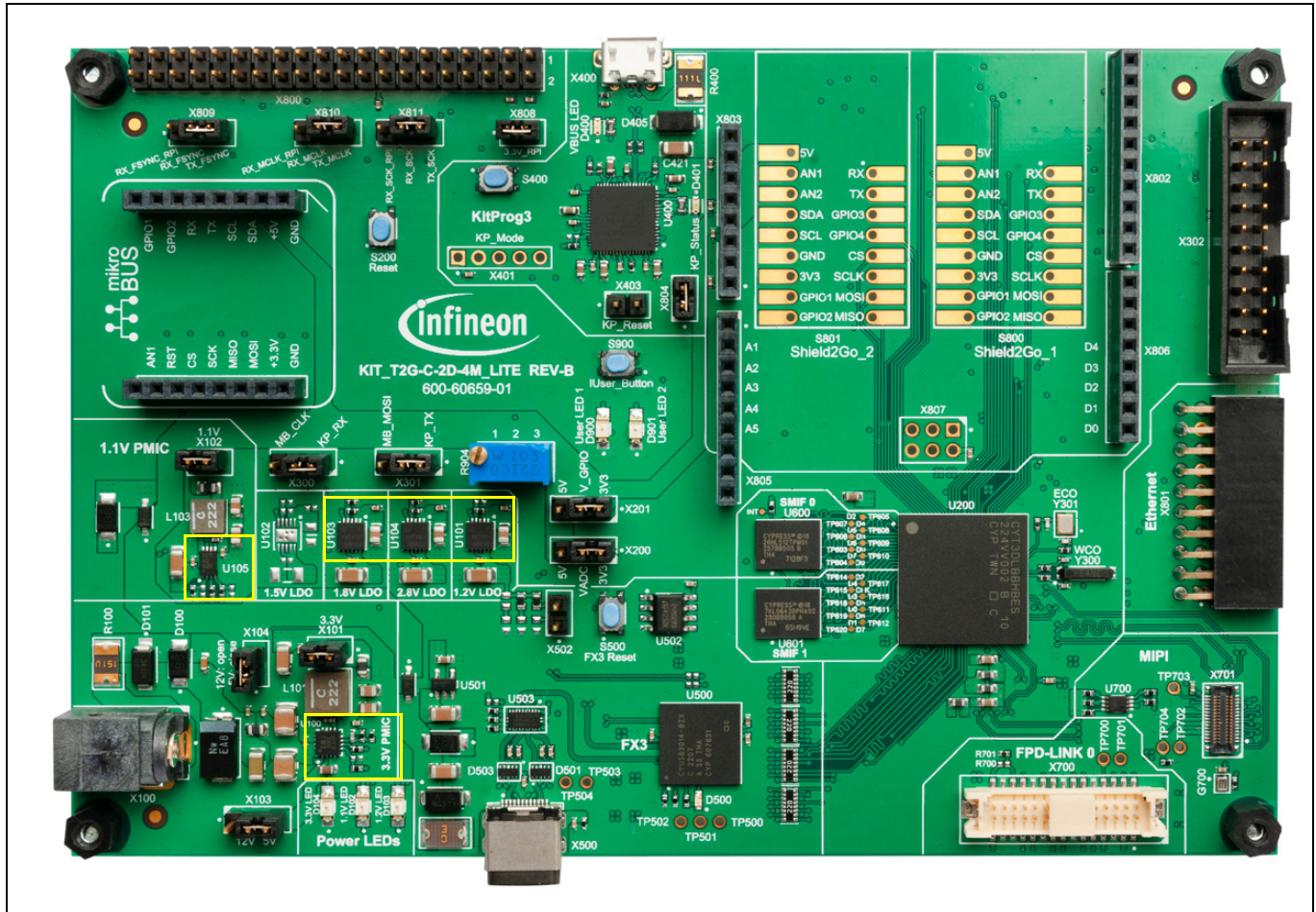

Figure 21 PMIC and LDO location

3.5 Program and debug interface

This kit has an Arm® Standard 20-pin JTAG connector to program and debug the CYT3DL device. Additionally, you can use the on-board debugger KitProg3 to program and debug the CYT3DL device.

You can use the GHS Probe directly to program and debug the kit by connecting it to the X302 connector. You can also use the JTAG-to-20-pin Arm® converter ([I-jet MIPI20 - Arm20 adapter](#)) to connect the I-jet with the X302 connector to program and debug it with the I-jet debugger.

3.5.1 KitProg3 programming interface

KitProg3 uses the industry-standard SWD protocols, such as CMSIS-DAP V2.0.0 and V1.2.0 as the bulk and HID endpoint transport mechanisms.

The KitProg USB-UART bridge helps you to program and debug the CYT3DL device just by connecting the Micro-B cable between the USB X400 Micro connector and the USB port of the PC. Refer to [Section 4](#) for more details.

[Figure 22](#) shows how to connect this kit with the PC for programming and debugging through KitProg3.

Hardware blocks

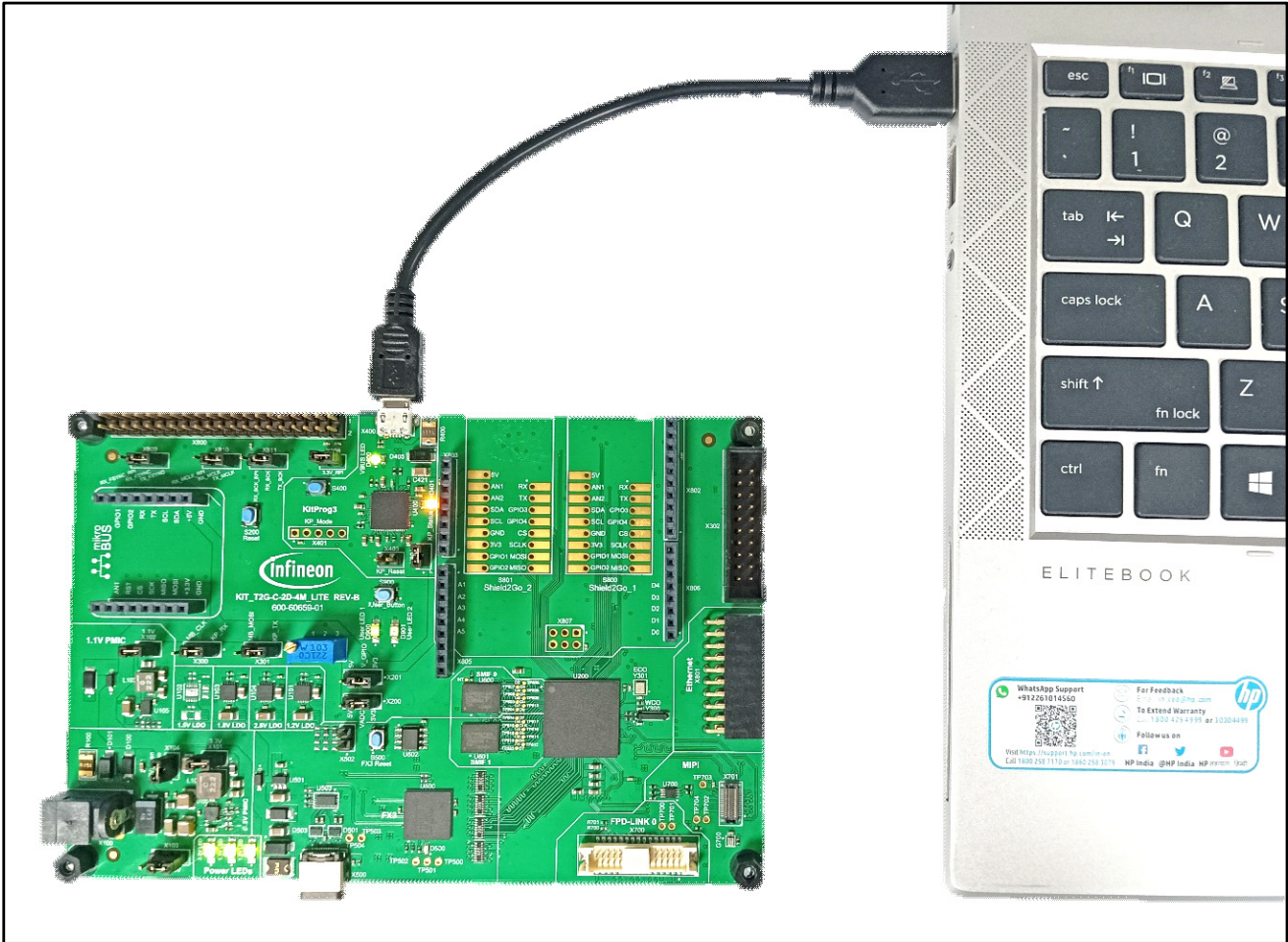

Figure 22 KitProg3 USB-UART bridge connected to PC

Note: Refer to [Section 4](#) for more details.

3.5.2 Arm® standard JTAG interface

Figure 23 shows the connection of the GHS probe to the JTAG header X302.

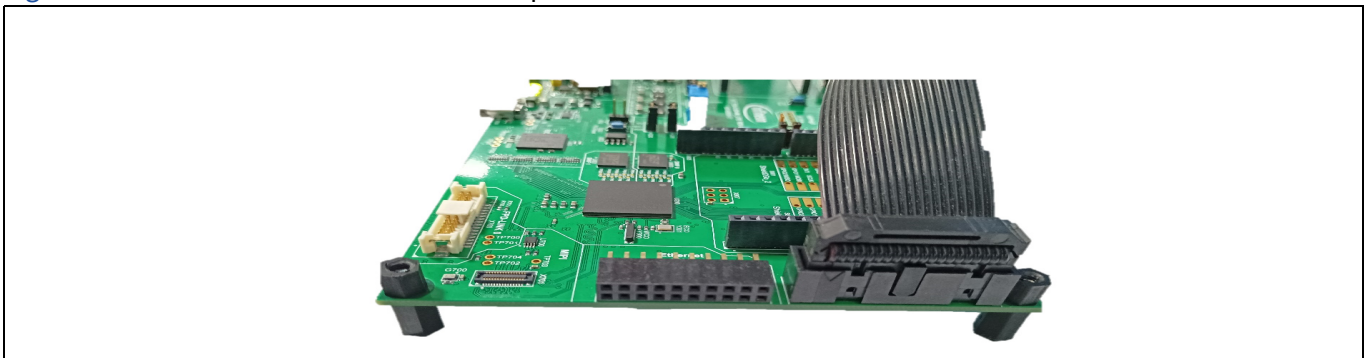

Figure 23 Connecting GHS Probe to JTAG header X302

Hardware blocks

Figure 24 shows the connection of the JTAG to the 20-pin Arm® converter from I-jet to the same JTAG header X302.

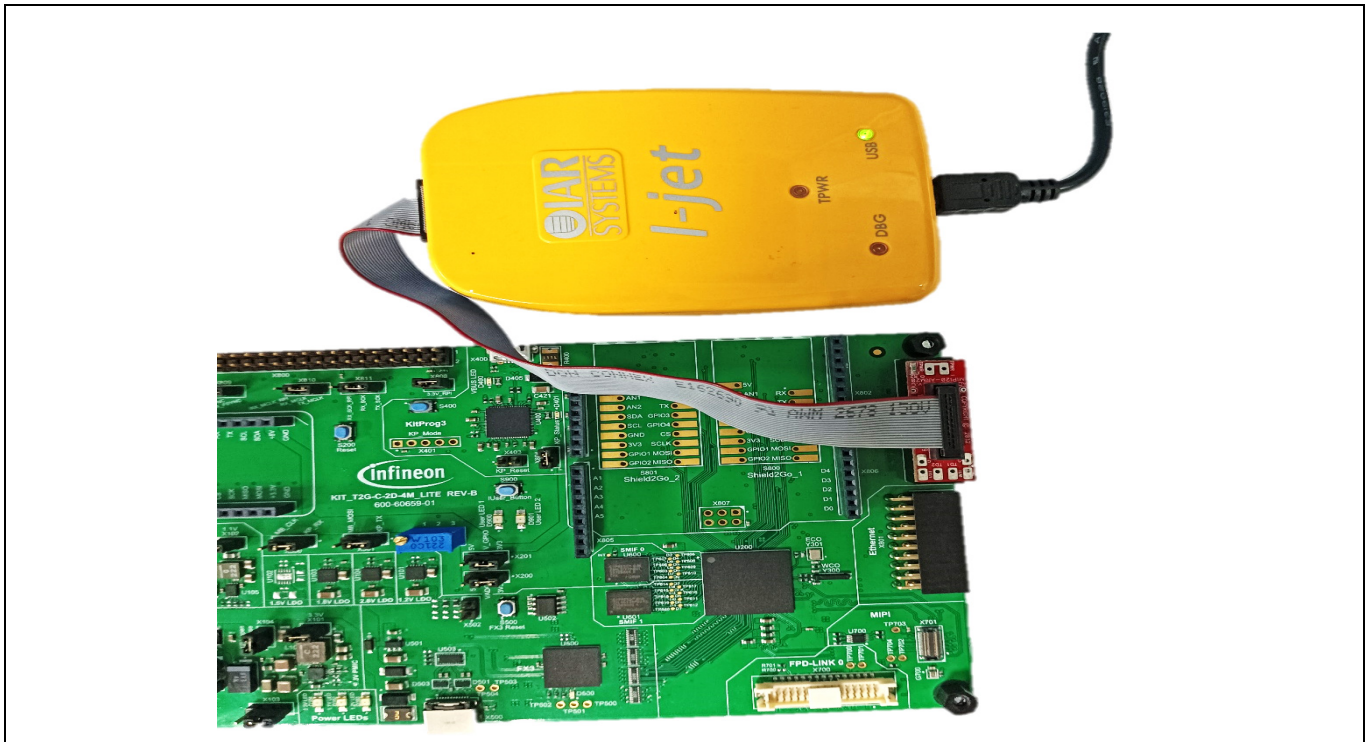

Figure 24 Connecting i-Jet to JTAG header X302

3.6 Serial memory interface

The Serial Memory Interface (SMIF) is a master that provides a low pin count connection to off-chip SPI devices, such as EEPROM, FRAM, MRAM, or NAND memories, in SDR or DDR mode, and HYPERBUS™ devices such as HYPERFLASH™ (NOR flash) and HYPERRAM™ (PSRAM and pseudo static RAM). SMIF provides two modes for data transfer operation to and from external devices:

- eXecute-In-Place (XIP) mode: The read and write transfers on the XIP AXI interface are translated on-the-fly to external device SPI transfers.
- MMIO mode: This mode supports MMIO-based accesses to external devices. The MMIO operation mode is less efficient than the XIP operation mode for read and write operations. However, it is more flexible than the XIP operation mode and this helps to implement other device operations in addition to read and write operations, such as programming and changing power modes.

This kit has two SMIF devices:

- SMIF0 – SEMPER™ Flash (S26HL)
- SMIF1 – HYPERRAM™ (S27KL)

Figure 25 shows the location of SEMPER™ Flash and HYPERRAM™ mounted in this kit.

Hardware blocks

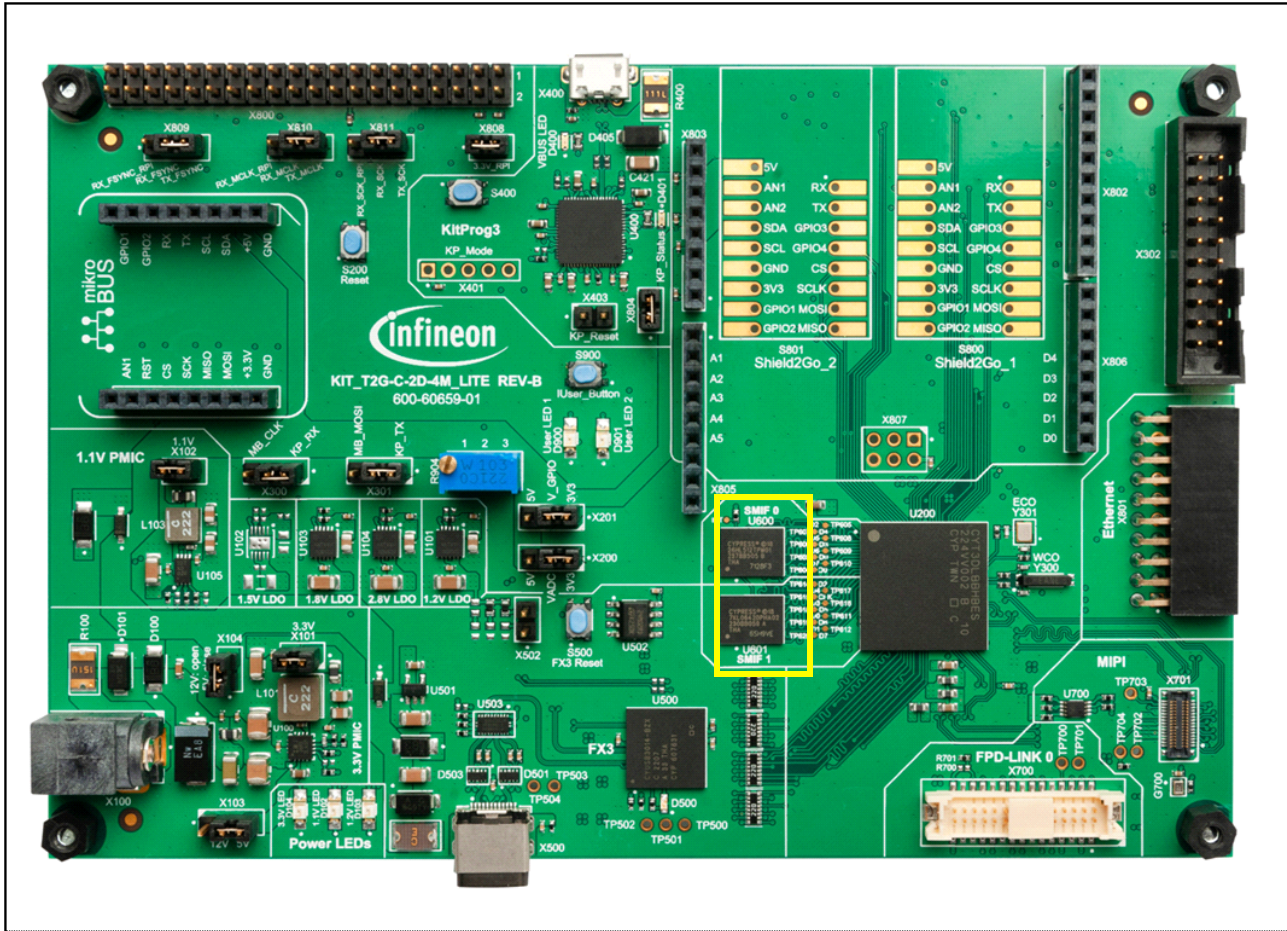

Figure 25 SEMPER™ Flash and HYPERRAM™ location

3.6.1 SEMPER™ Flash

The TRAVEO™ T2G Cluster 4M Lite kit has the S26HL512T 512 Mb SEMPER™ Flash, which is a high-speed CMOS, MIRRORBIT™ NOR Flash device compliant with the JEDEC JESD251 eXpanded SPI (xSPI) specification. SEMPER™ Flash is designed for functional safety with development according to the ISO 26262 standard to achieve ASIL-B compliance and ASIL-D readiness.

SEMPER™ Flash with HYPERBUS™ interface devices support both the HYPERBUS™ interface as well as legacy (x1) SPI. Both interfaces serially transfer transactions reducing the number of interface connection signals.

3.6.2 HYPERRAM™

This kit has S27KL0642 64-Mb HYPERRAM™ self-refresh DRAM (PSRAM). The Infineon 64-Mb HYPERRAM™ device is a high-speed CMOS, self-refresh DRAM, with HYPERBUS™ interface. The DRAM array uses dynamic cells that require periodic refresh.

The refresh control logic within the device manages the refresh operations on the DRAM array when the memory is not actively read or written by the HYPERBUS™ interface master (host). Since the host is not required to manage any refresh operations, the DRAM array appears to the host as though the memory uses static cells that retain data without refresh. Hence, the memory is more accurately described as Pseudo Static RAM (PSRAM).

Note: For datasheet and more details about SEMPER™ Flash and HYPERRAM™, refer to the [References](#) section at the end of the document.

Hardware blocks

3.7 Graphics and video interface

This kit supports different video-compatible interfaces that can be accessed via specific connectors and supported by compatible components such as displays, camera, and adapter boards.

Figure 26 shows the different video and graphic interfaces available in this kit.

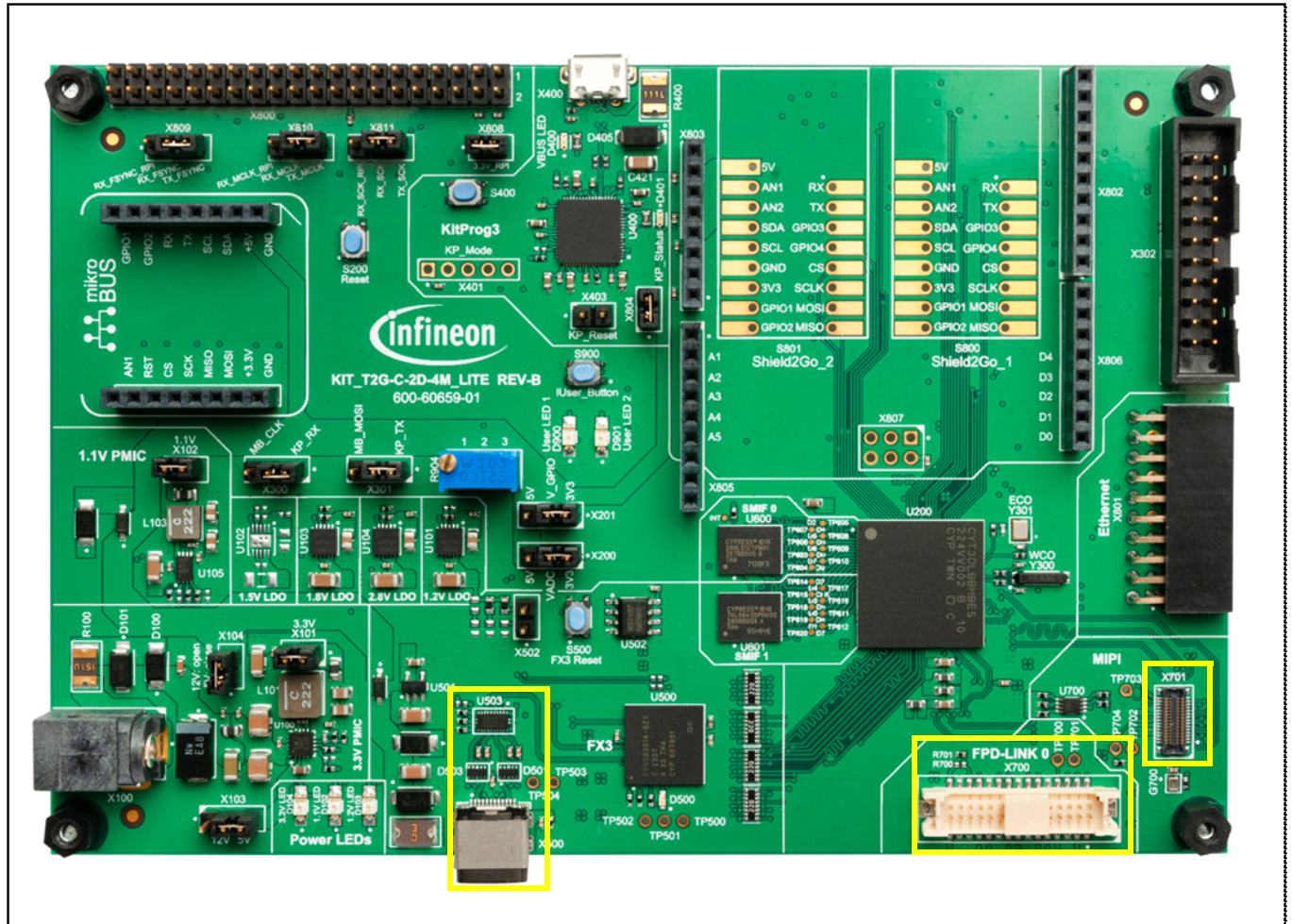

Figure 26 Video interfaces

3.7.1 EZ-USB™ FX3 interface

This kit supports the FX3 video interface via a Type-C connector to stream the graphics output on the screen. It is a plug-and-play device as EZ-USB™ FX3 comes with the necessary firm_ware preloaded. The RGB display signals coming from the CYT3DL device are converted into USB 3.2 packets by FX3 and streamed to a PC. The PC detects the FX3 as a camera and thus any media player application (such as an MPC Player or VLC) can display the graphics streamed by it.

For streaming, you can use any media player (refer to [Section 2.3](#) for configuring the media player and FX3 to stream graphics output).

Figure 27 shows the connection of the Type-C cable required to stream FX3 into PC; also, ensure that jumper X502 is not shorted in this kit.

Hardware blocks

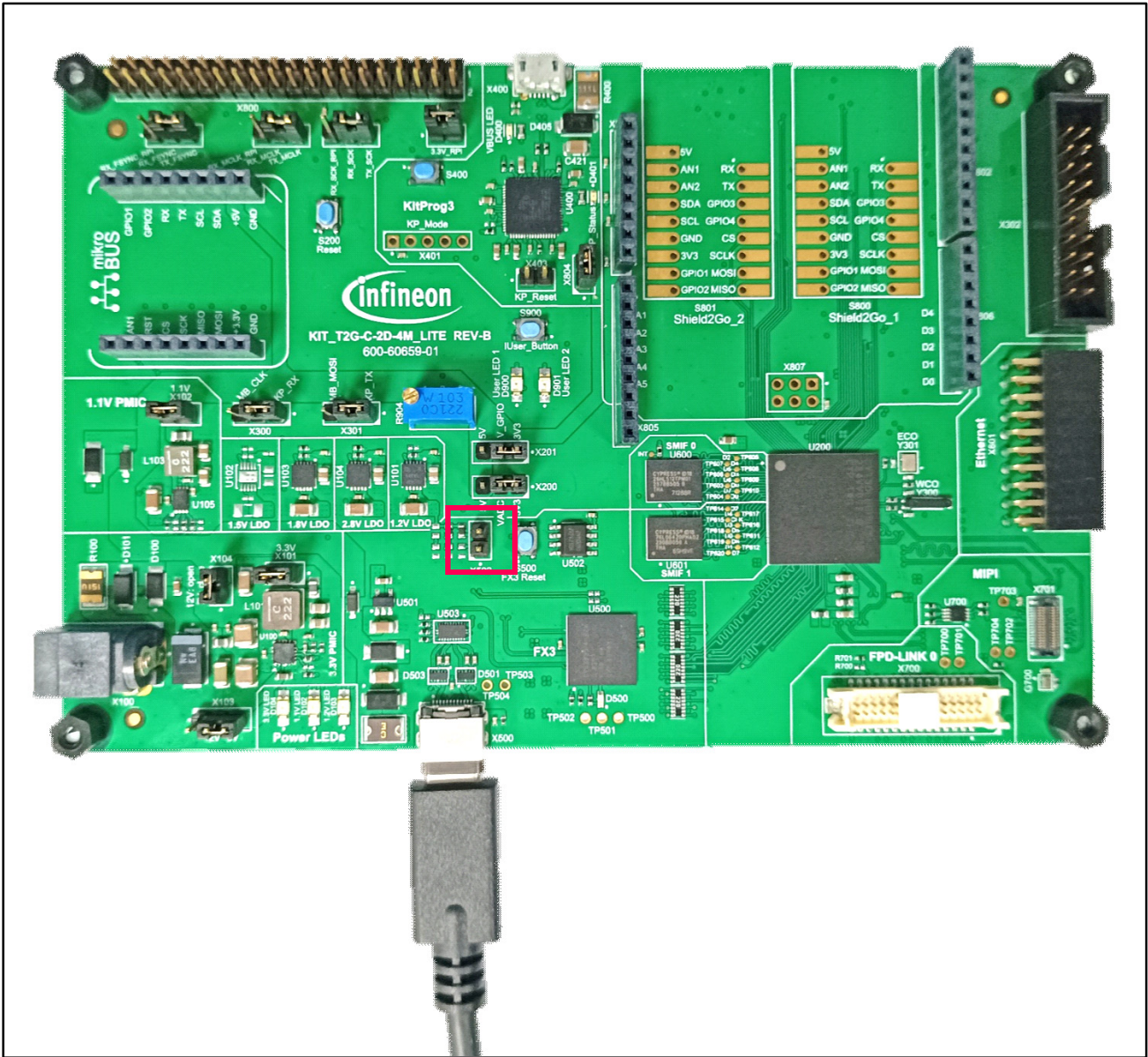

Figure 27 Connection required to stream FX3 into PC

Note: If you want to program the EZ-USB™ FX3, connect the jumper X502 (highlighted in Figure 27) on the board. Ensure that you connect and disconnect the power again in the lite kit after this jumper configuration.

Note: If you want to stream the graphics output via EZ-USB™ FX3, remove the jumper X502 (highlighted in Figure 27) from the board.

Hardware blocks

3.7.2 FPD-Link interface

This kit has one FPD-Link interface and it supports graphics output. Connect the FPD-Link display to stream graphics output.

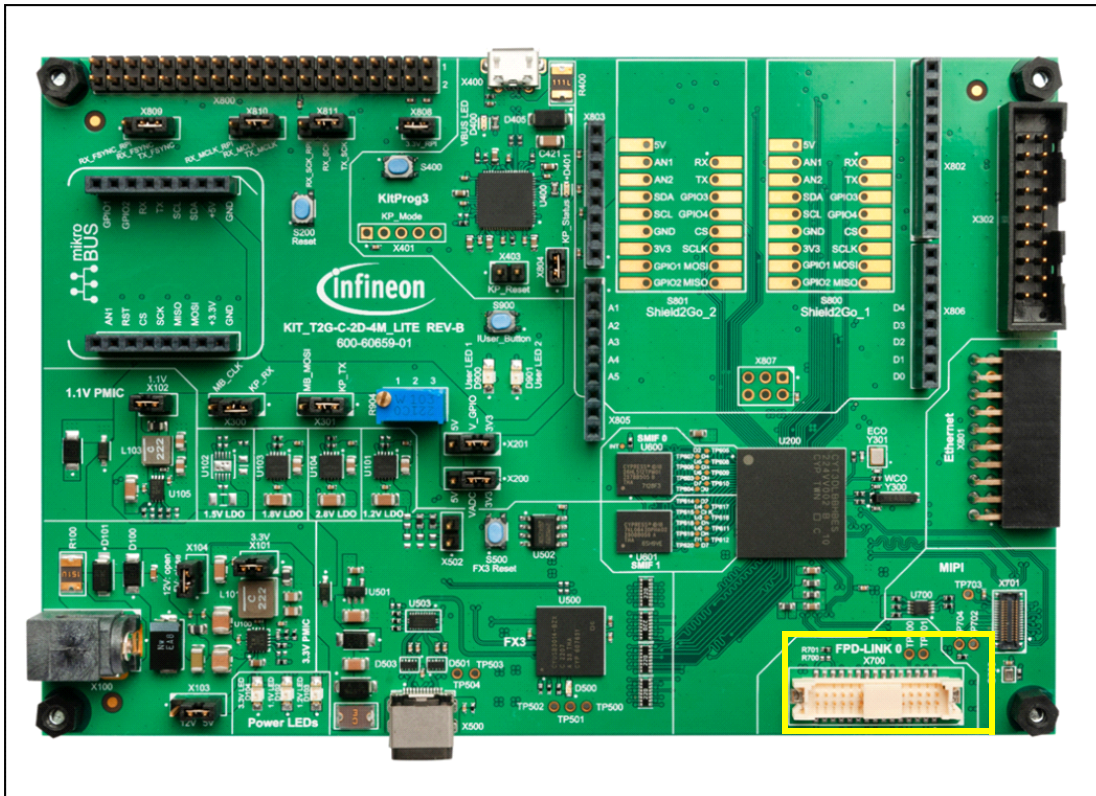

Figure 28 FPD-Link connector location on the TRAVEO™ T2G Cluster 4M Lite kit

3.7.3 MIPI-CSI2 interface

This kit supports the MIPI-CSI2 interface. Since the CSI2 (Camera Serial Interface) receiver is a part of the CYT3DL device, you need an external camera module to transmit the video stream to the device. The MIPI CSI-2 interface (X701) supports multiple imaging formats like YUV, RGB, and raw format. This connector is compatible with an e-CON camera module ([e-CAM52A_5640_MOD MIPI camera](#)).

Hardware blocks

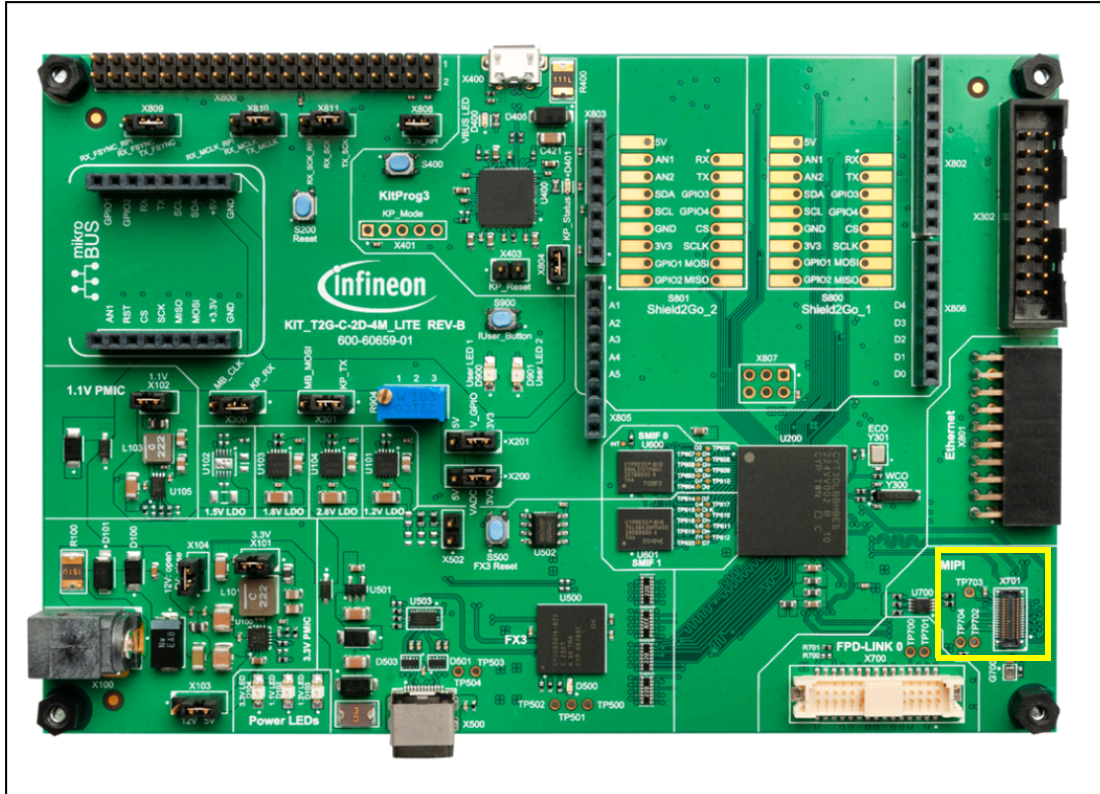

Figure 29 MIPI-CSI2 interface location in TRAVEO™ T2G Cluster 4M Lite kit

3.8 HID interface

This kit supports several Human Interface Device (HID) interfaces to take input or show some indication to the user. The board contains two user LEDs (D900, D901), one user push button (S900), and one potentiometer (R904).

Figure 30 shows the location of user LEDs, push buttons, and potentiometer in this kit.

Hardware blocks

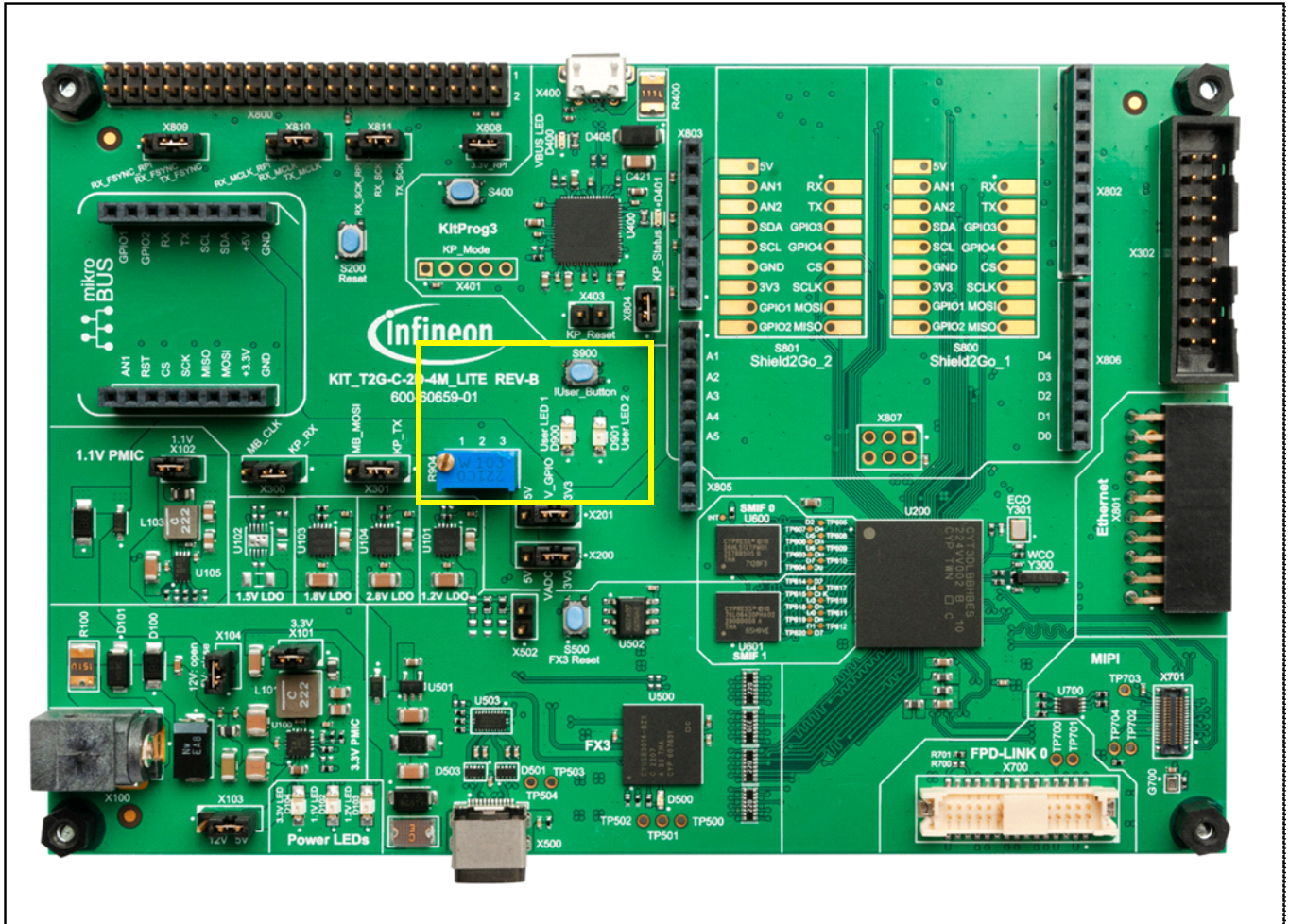

Figure 30 User LEDs, push button and potentiometer in TRAVEO™ T2G Cluster 4M Lite kit

3.8.1 User LEDs

Since the LEDs used on the board are active high, the corresponding GPIO can be used to control the LED (high - LED on and low - LED off) from the CYT3DL device.

3.8.2 User push button

The user push button used on the board is tied to a pull-up resistor and works as an active low input to the CYT3DL device; therefore, pushing the button down triggers a falling edge on that particular GPIO port pin.

3.8.3 Potentiometer

The potentiometer works as a variable resistor connected on the analog pin of the CYT3DL device. Since the VDDA power reference is given to the potentiometer, any change in its position has a relative effect on the ADC conversion result.

Hardware blocks

3.9 Crystal oscillator

This kit supports two external clock sources: External Crystal Oscillator (ECO) and Watch Crystal Oscillator (WCO). Figure 31 shows the location of the crystal oscillators in this kit.

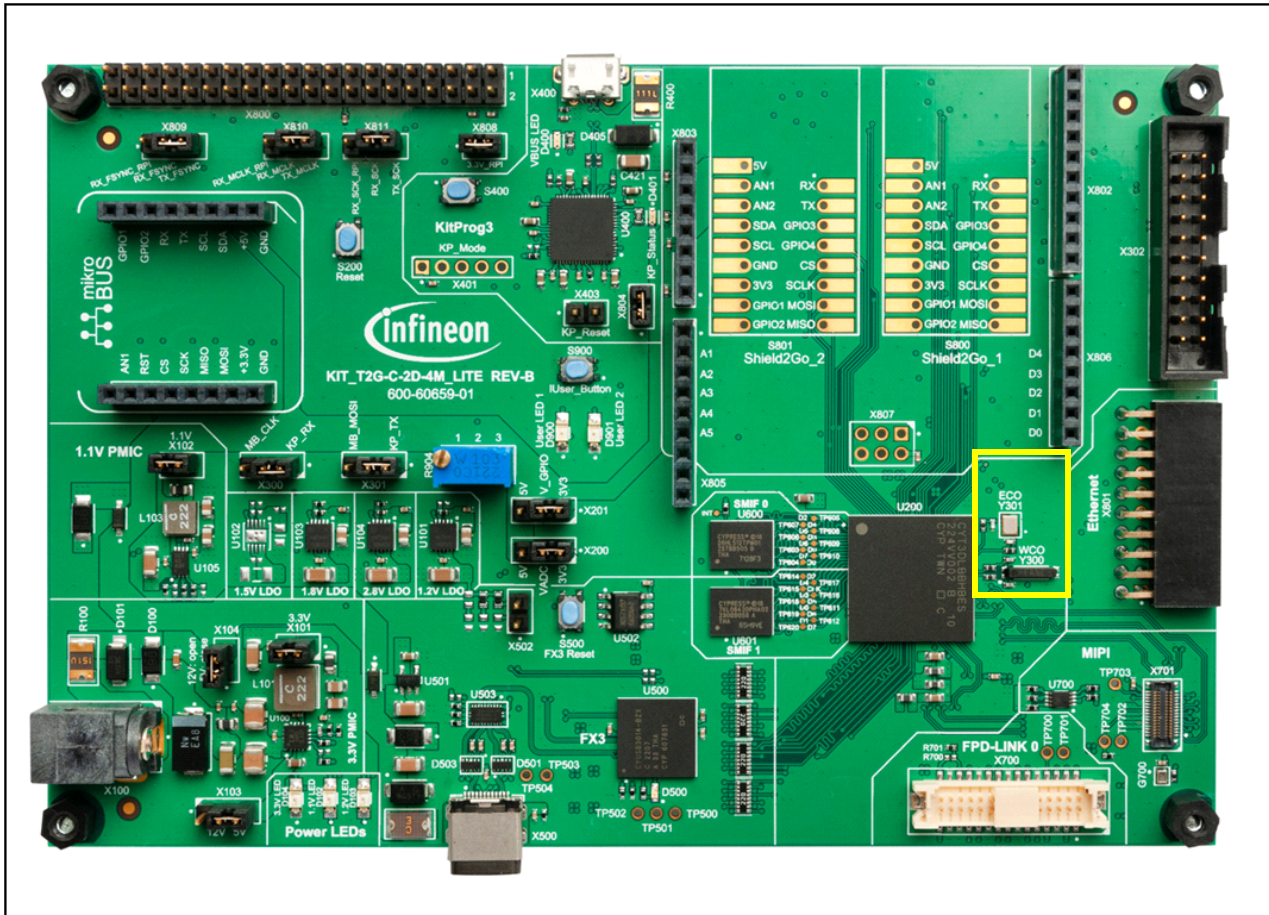

Figure 31 ECO and WCO location

Note: The ECO gives a 16-MHz clock output while the WCO gives a 32.768-kHz clock output.

3.10 Reset buttons

There are two reset buttons and one reset jumper present on the board. The reset buttons are for the CYT3DL device reset and FX3 reset. The X403 jumper is used to reset the on-board debugger KitProg3.

- S200 - MCU device reset
- S500 - FX3 reset
- X403 - KitProg3 reset

Figure 32 shows the locations of these reset buttons in this kit.

Hardware blocks

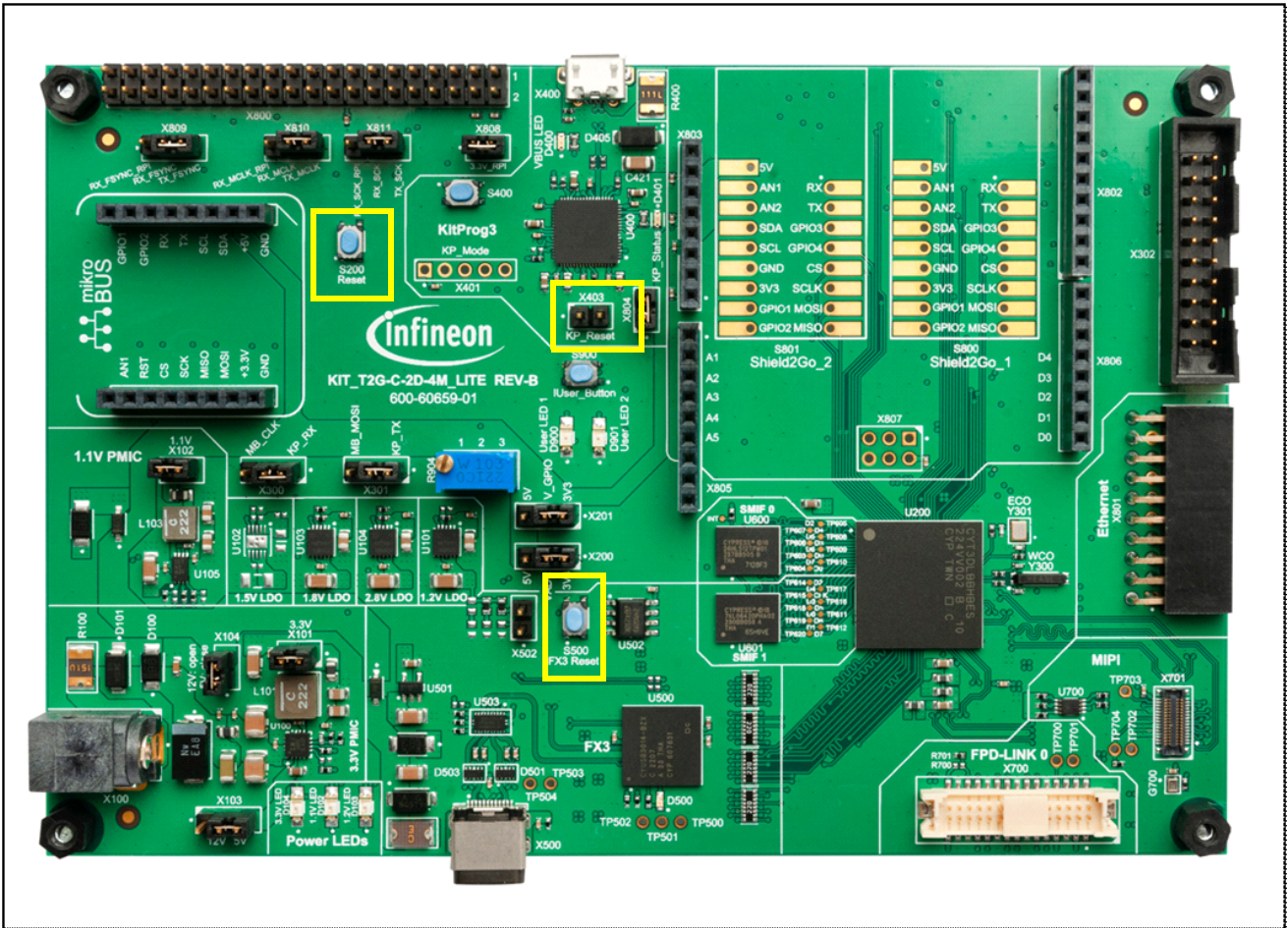

Figure 32 Reset buttons

3.11 Expansion headers

This kit provides a variety of header expansions that are compatible with the most popular interfaces. The kit is designed to be compatible with Arduino™ I/O connection header, mikroBUS™ header, and Shield2Go footprints. There is also one Raspberry Pi compatible header, which can be used with the Audio HAT for I2S Audio.

Figure 33 shows the different headers locations in this kit.

Hardware blocks

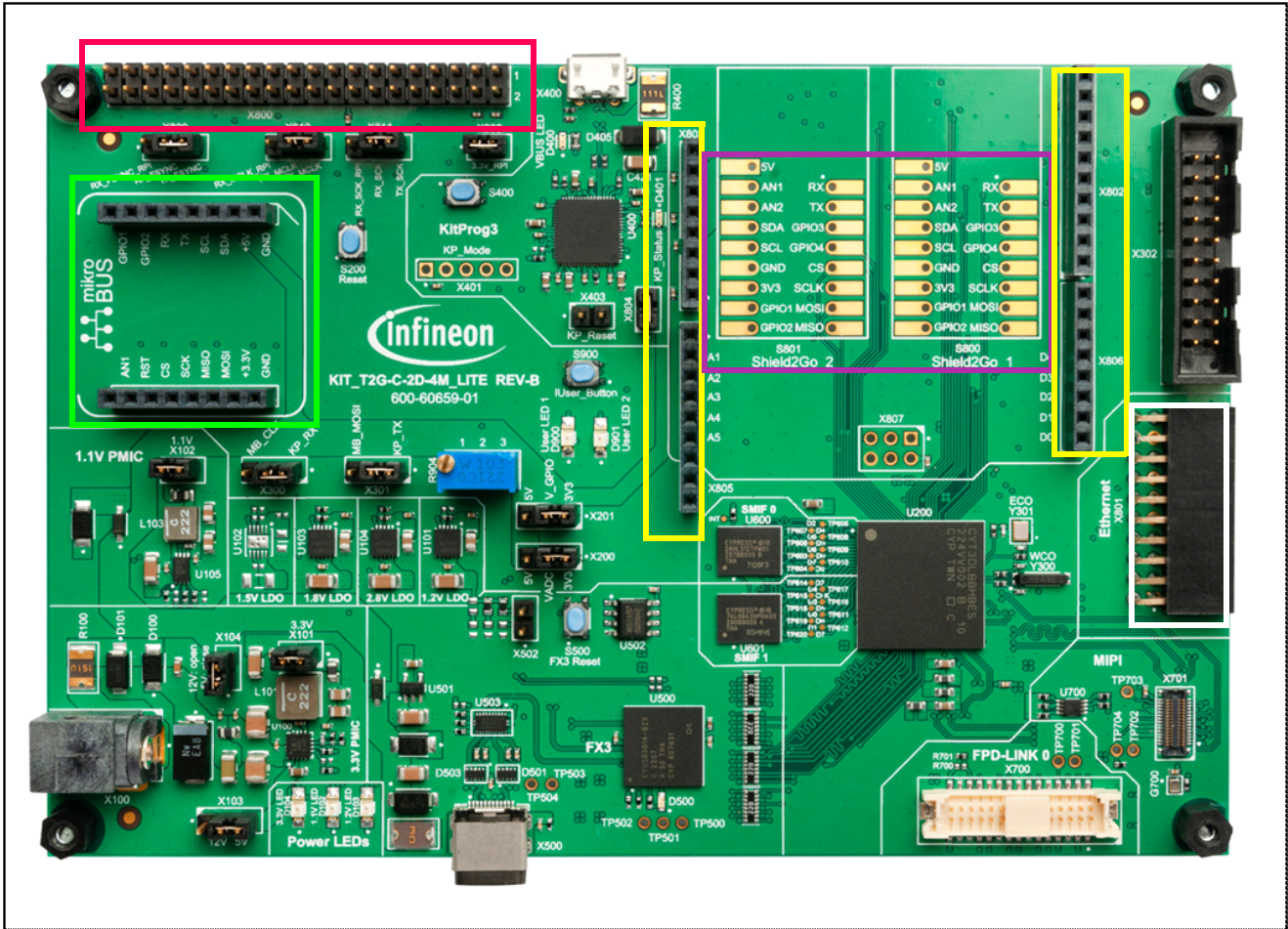

Figure 33 Expansion headers

- Raspberry Pi compatible I/O header (highlighted in red)
- Arduino-compatible header (highlighted in yellow)
- mikroBUS™ compatible header (highlighted in green)
- Shield2Go footprints (highlighted in pink)
- PMOD connector for ethernet (highlighted in white).

3.11.1 Raspberry Pi I/O header

Table 5 Raspberry Pi header pin details

Pin	Functionality
X800.1	3V3
X800.2	5V0
X800.3	SCB2 I2C SDA
X800.4	5V0
X800.5	SCB2 I2C SCL
X800.6	GND
X800.7	GPIO1 (P7.1)
X800.8	SCB6 UART RX
X800.9	GND

Hardware blocks

Pin	Functionality
X800.10	SCB6 UART TX
X800.11	GPIO2 (P7.2)
X800.12	TDM TX SCK0
X800.13	GPIO3 (P7.3)
X800.14	GND
X800.15	GPIO4 (P8.0)
X800.16	TDM RX SCK0
X800.17	3V3
X800.18	TDM TX MCK0
X800.19	SCB7 SPI MOSI
X800.20	GND
X800.21	SCB7 SPI MISO
X800.22	GPIO9 (P7.1)
X800.23	SCB7 SPI CLK
X800.24	SCB7 SPI SEL0
X800.25	GND
X800.26	SCB7 SPI SEL1
X800.27	SCB2 I2C SDA
X800.28	SCB2 I2C SCL
X800.29	GPIO5 (P8.1)
X800.30	GND
X800.31	GPIO6 (P9.2)
X800.32	GPIO8 (P9.0)
X800.33	TDM RX MCK0
X800.34	GND
X800.35	TDM TX FSYNC0
X800.36	GPIO7 (P8.3)
X800.37	TDM RX FSYNC0
X800.38	TDM RX SD0
X800.39	GND
X800.40	TDM TX SD0

3.11.2 Arduino header

Table 6 Arduino header X802 pin details

Pin	Functionality
X802.1	LIN0 TX
X802.2	LIN0 RX
X802.3	SCB8 SPI SEL0
X802.4	SCB8 SPI MOSI
X802.5	SCB8 SPI MISO
X802.6	SCB8 SPI CLK
X802.7	GND
X802.8	VADC
X802.9	SCB2 I2C SCL
X802.10	SCB2 I2C SDA

Hardware blocks

Table 7 Arduino header X803 pin details

Pin	Functionality
X803.1	VIN
X803.2	GND
X803.3	GND
X803.4	5V0
X803.5	3V3
X803.6	XRES#
X803.7	VDDIO
X803.8	NC

Table 8 Arduino header X805 pin details

Pin	Functionality
X805.1	AN1 (P4.4)
X805.2	AN2 (P4.5)
X805.3	AN3 (P2.0)
X805.4	AN4 (P5.0)
X805.5	SCB2 I2C SDA
X805.6	SCB2 I2C SCL
X805.7	DAC_AOUT_R
X805.8	DAC_AOUT_L
X805.9	DAC_COM_R

Table 9 Arduino header X806 pin details

Pin	Functionality
X806.1	LIN1 TX
X806.2	LIN1 RX
X806.3	DAC_COM_L
X806.4	GPIO3 (P11.1)
X806.5	CAN0 TX
X806.6	CAN0 RX
X806.7	GPIO2 (P8.2)
X806.8	GPIO1 (P4.2)

3.11.3 mikroBUS header

Table 10 mikroBUS header 812 pin details

Pin	Functionality
X812.1	AN1 (P5.3)
X812.2	RST
X812.3	SCB7 SPI SEL0
X812.4	SCB7 SPI CLK
X812.5	SCB7 SPI MISO
X812.6	SCB7 SPI MOSI
X812.7	3V3
X812.8	GND

Hardware blocks

Table 11 mikroBUS header 813 pin details

Pin	Functionality
X813.1	GPIO1 (P19.3)
X813.2	GPIO2 (P21.3)
X813.3	SCB6 UART RX
X813.4	SCB6 UART TX
X813.5	SCB2 I2C SCL
X813.6	SCB2 I2C SDA
X813.7	5V0
X813.8	GND

3.11.4 Ethernet header

Table 12 Ethernet header X801 pin details

Pin	Functionality
X801.8	TXD1
X801.9	TXD0
X801.10	TX_EN
X801.11	RXD1
X801.12	RXD0
X801.13	CRSDV
X801.14	REF_CLK
X801.15	MDC
X801.16	MDIO
X801.17	GND
X801.18	GND
X801.19	VCC
X801.20	VCC

3.11.5 Shield2Go

Shield2Go footprints are available on this kit and you can mount the header based on your requirement.

3.12 Supported shields

This kit supports various shields to use different peripherals, which are not available on the board, but can be used by connecting to the I/O headers of the kit.

[Figure 34](#) shows the available shields that you can use with different I/O headers of this kit.

Hardware blocks

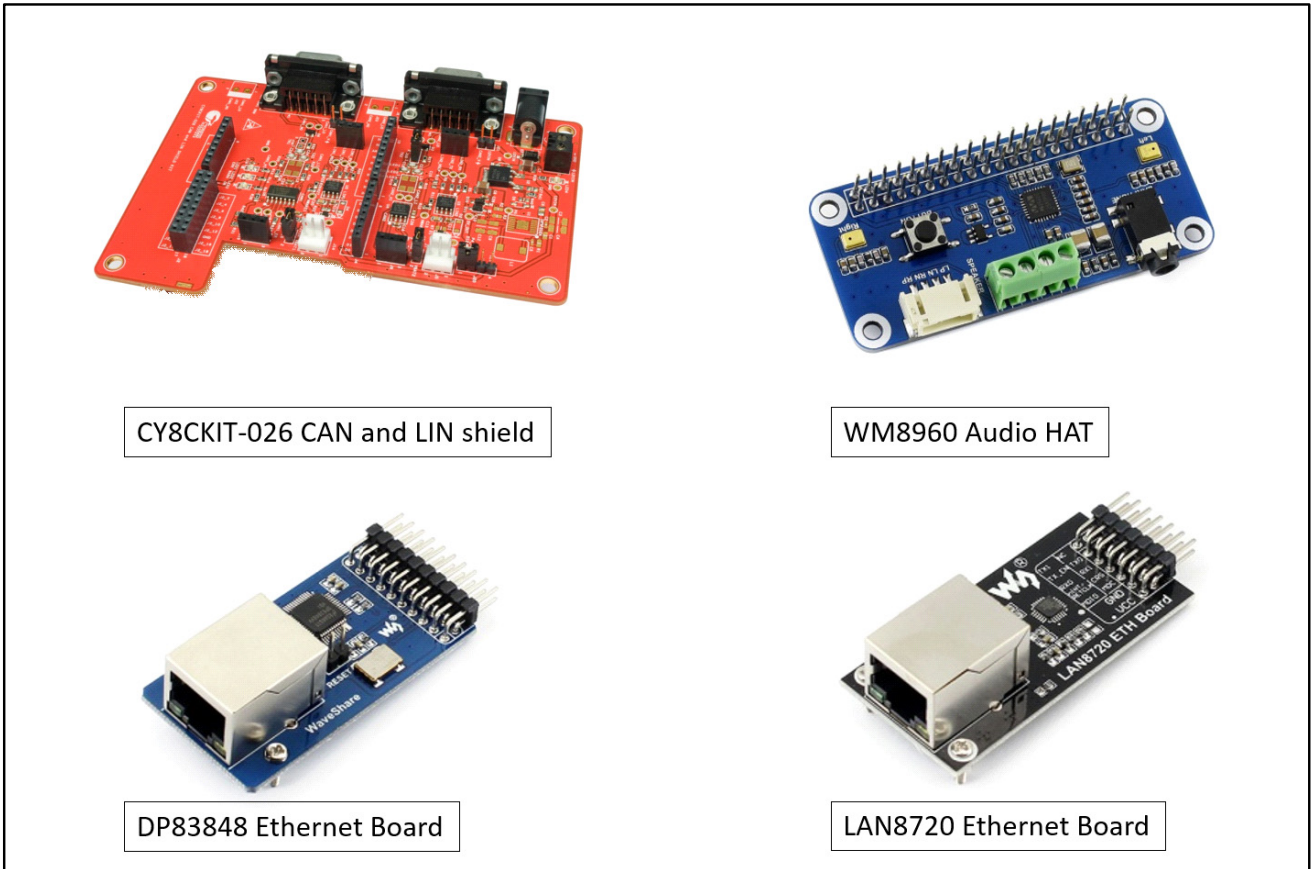

Figure 34 Different shields supported by TRAVEO™ T2G Cluster 4M Lite kit

3.12.1 CY8CKIT-026 CAN and LIN Shield Kit

This kit supports the CY8CKIT-026 CAN and LIN Shield kit, which is an Arduino-compatible shield board used with several Infineon kits such as the CY8CKIT-042 PSoC™ 4 Pioneer Kit/CY8CKIT-044 PSoC™ 4 M-Series Pioneer Kit or the FM4-176L-S6E2GM - Arm® Cortex®-M4 MCU Pioneer Kit. It enables you to evaluate the Controller Area Network (CAN) and Local Interconnect Network (LIN) slave communication capabilities of CYT3DL device.

By default, the TRAVEO™ T2G Cluster 4M Lite kit does not come with CAN and LIN transceivers but by using this shield, you can use those communication protocols in the TRAVEO™ T2G Cluster 4M Lite kit.

Figure 35 shows how to connect the CAN and LIN shield with this kit.

Hardware blocks

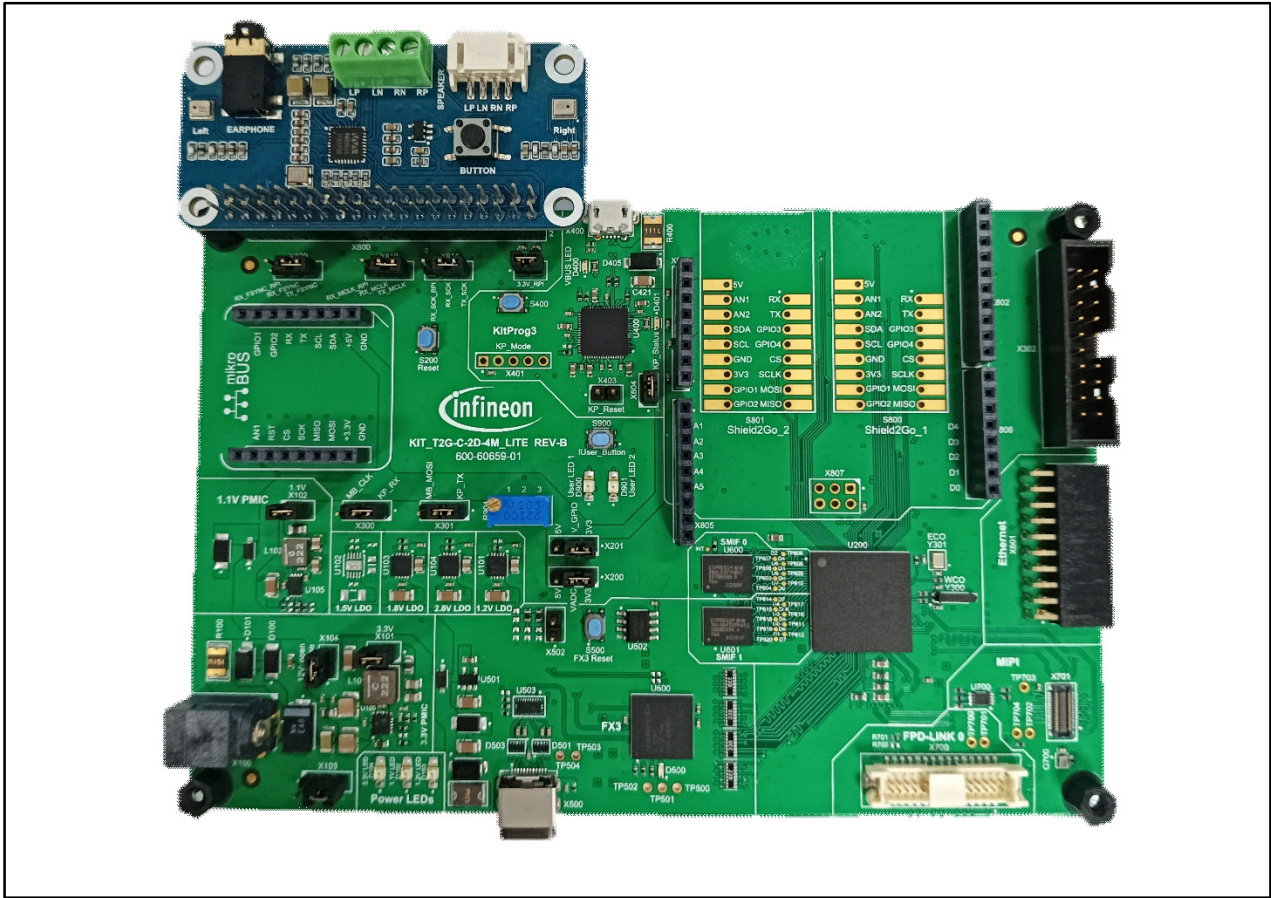

Figure 36 Connecting WM8960 Audio HAT

3.12.3 Ethernet board

This kit does not have on-board ethernet PHY but you can use the external ethernet PHY boards by connecting them to the PMOD connector (X801) on the board. The following sections provide details about the boards which are supported with this kit for ethernet.

3.12.3.1 DP83848 Ethernet board

The DP83848 ethernet board is an accessory board that includes an onboard Ethernet Physical Layer Transceiver DP83848, RJ45 connector, and control interface.

3.12.3.2 LAN8720 Ethernet board

The LAN8720 ethernet board supports RMII interface with a 10/100 ethernet transceiver LAN8720.

Figure 37 shows how to connect the DP83848 and LAN 8720 ethernet board with this kit.

Hardware blocks

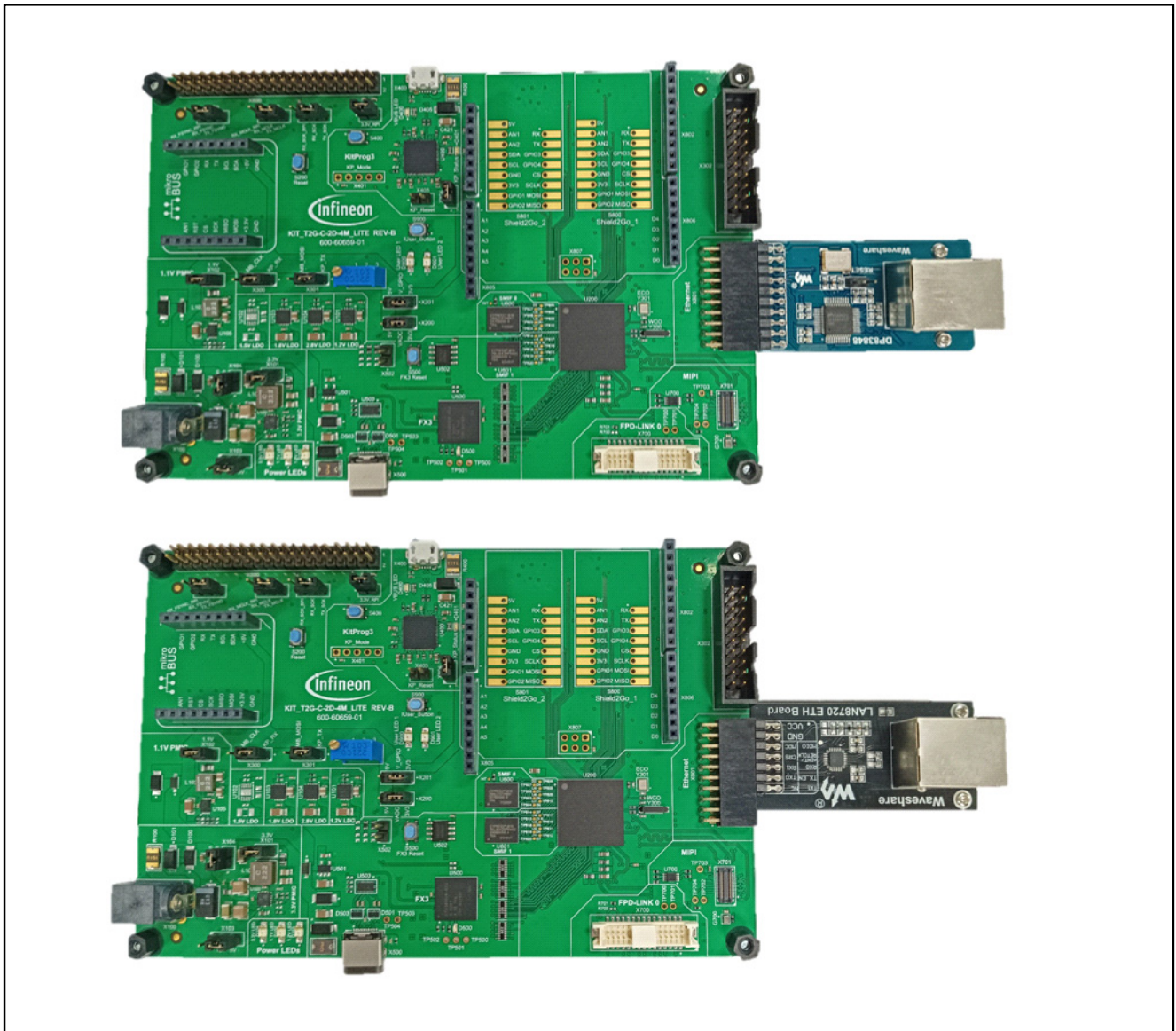

Figure 37 Connecting external ethernet boards with this kit

Programming and debugging

4 Programming and debugging

This section describes how to program and debug this kit. The FX3 programming steps are also described in this section.

4.1 Program CYT3DL device using AutoFlashUtility

The AutoFlashUtility is a flexible, cross-platform, integrated application to allow programming Infineon devices. It can perform Program, Erase, Verify, and Read operations on the target device flash. It can target an entire device, a specific region, a sector, and even a byte of a device (contact [Technical Support](#) to obtain the tool).

To use AutoFlashUtility tool in this kit, connect a micro-B cable between X400 and the USB port of the PC for using the on-board debugger/programmer KitProg3. After that, run the commands from the command prompt to use that AutoFlashUtility tool for flashing codes. The tool does not support debugging and should be used only for programming.

Figure 38 shows the connection between USB micro-B X400 and the USB port of the PC to flash the code via the AutoFlashUtility tool.

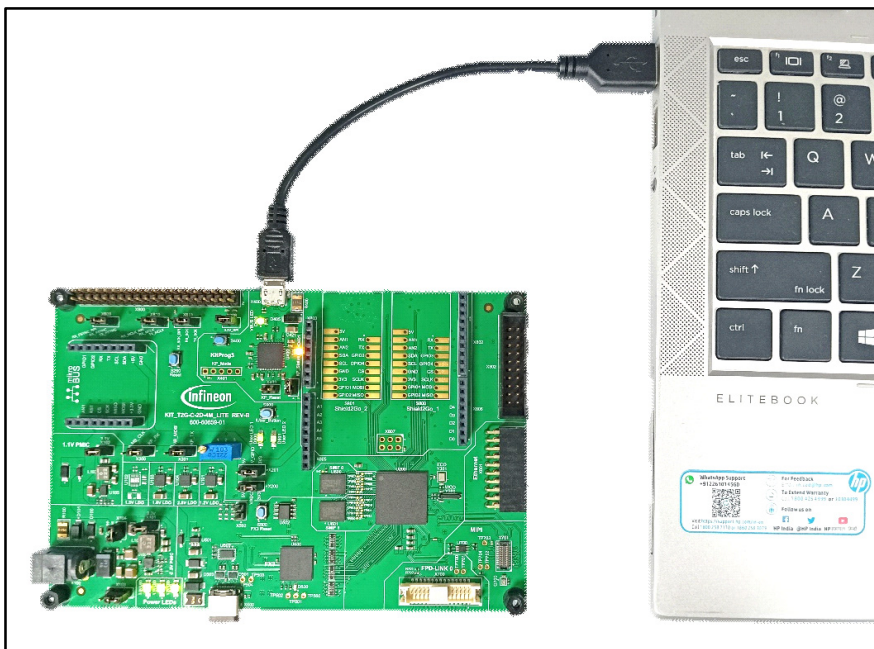

Figure 38 Connecting cable between X400 and PC for flashing via AutoFlashUtility

Note: Currently, we do not publish AutoFlashUtility on the web; contact traveo@infineon.com if you need this tool.

Programming and debugging

4.2 Program and debug CYT3DL device using IAR Embedded Workbench

This kit supports the programming and debugging using the third-party software and hardware like IAR-EWARM (embedded workbench for Arm® software and I-Jet debugger) and Green Hills System (Multi IDE software and GHS probe debugger).

Download the latest Sample Driver Library (SDL) for the TRAVEO™ T2G Cluster 4M Lite kit in the PC. Install the SDL outside the default program files to allow the IDE to access and create temporary files.

Open the *Readme.pdf* from the root folder of the SDL and use the same link to download the version of IAR EWARM supported by the SDL. Download the software and run the installation (note that the installation might take some time).

When you open the IAR EWARM for the first time, select the license in the License wizard. If you do not have the license, it is strongly recommended to register for a code size limited license type. After downloading and setting-up the IDE, extract the folder available in the following path: *SDL (version 7.9.0 or higher) -> misc. -> tools -> iar -> IAR_EWARM_9301_FlashLoader_Patch_TraveoII.zip*, and follow the *readme.txt* document available there for patch files copying to support SDL and the device with that IDE.

The CYT3DL device is now ready to program and debug by connecting the I-Jet debugger with [i-Jet MIPI20 - Arm20 adapter](#) to the X302 jumper on the board. Refer to [Section 4.3](#) to use the Micro-B cable to X400 with flashing through the KitProg3 USB-UART bridge.

There are two debugging methods with IAR EWARM:

- 1. Debugging with download on the RAM.
- 2. Debugging with download on the Flash (described in this document).

Follow these steps to download and debug using the CM0+ core workspace:

- 1. Start IAR EWARM 9.32.1 and go to "file\open workspace", and then select the following path: *T2G_Sample_Driver_Library_7.9.0\ tviiic2d4m\ tools\ iar\ flash\ tviiic2dd4m_flash_cm0plus_template*.

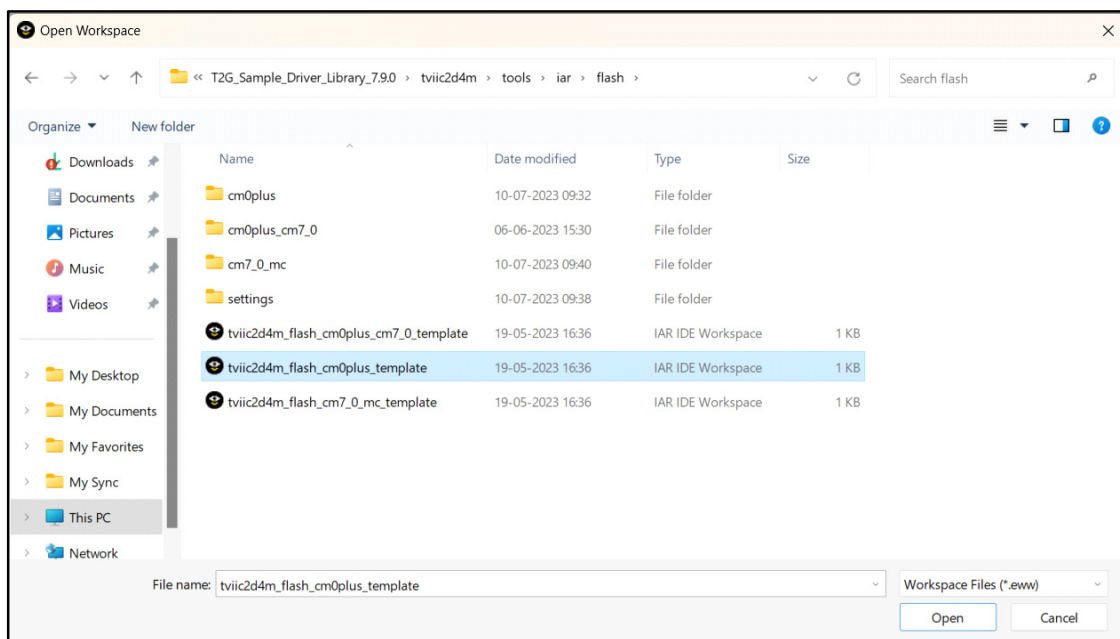

Figure 39 Opening workspace in IAR EWARM

Programming and debugging

2. Select the revision in the workspace tab as "lite_kit" from the drop-down list under Workspace, as shown in Figure 40.

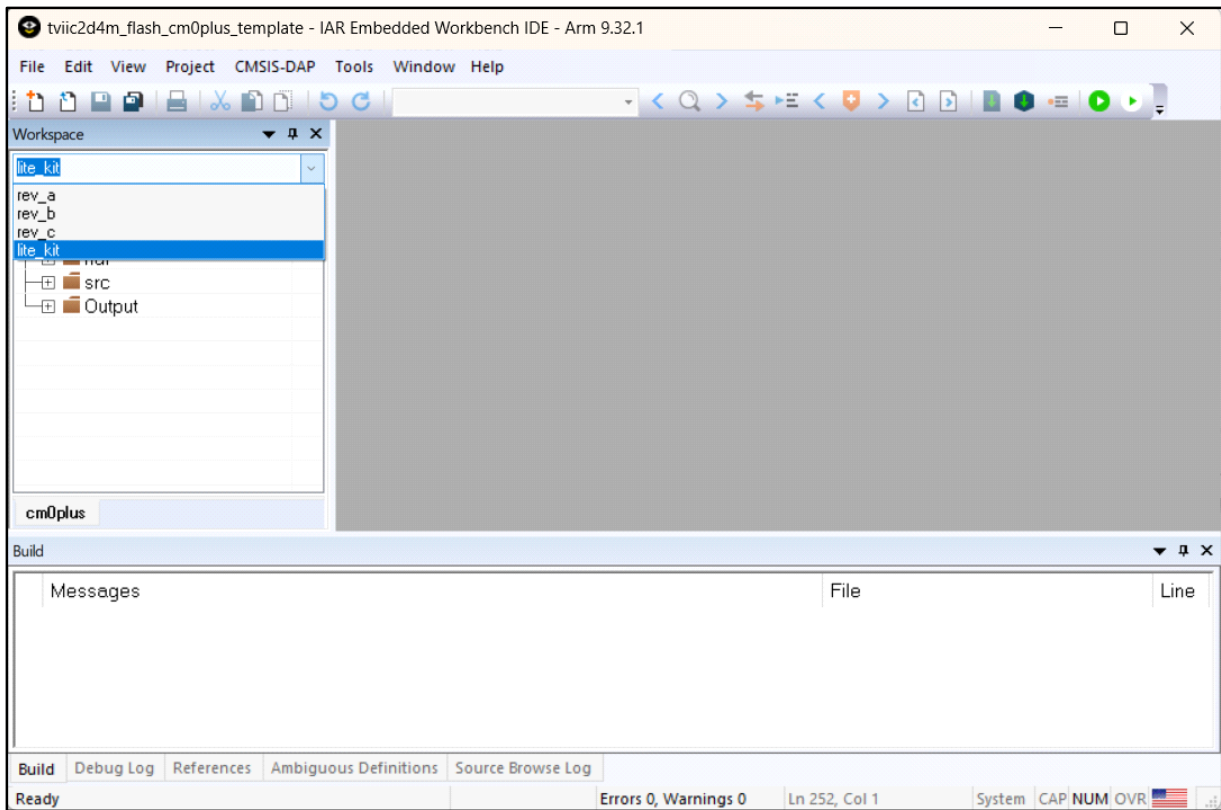

Figure 40 Selecting lite_kit workspace for TRAVEO™ T2G Cluster 4M Lite kit in IAR

Note: Ignore the other workspace revisions for this lite_kit. The other revisions constitute the MCU assembled on other evaluation boards (CPU boards).

3. In that workspace tab, expand the src folder to find the "main_cm0plus.c" file.

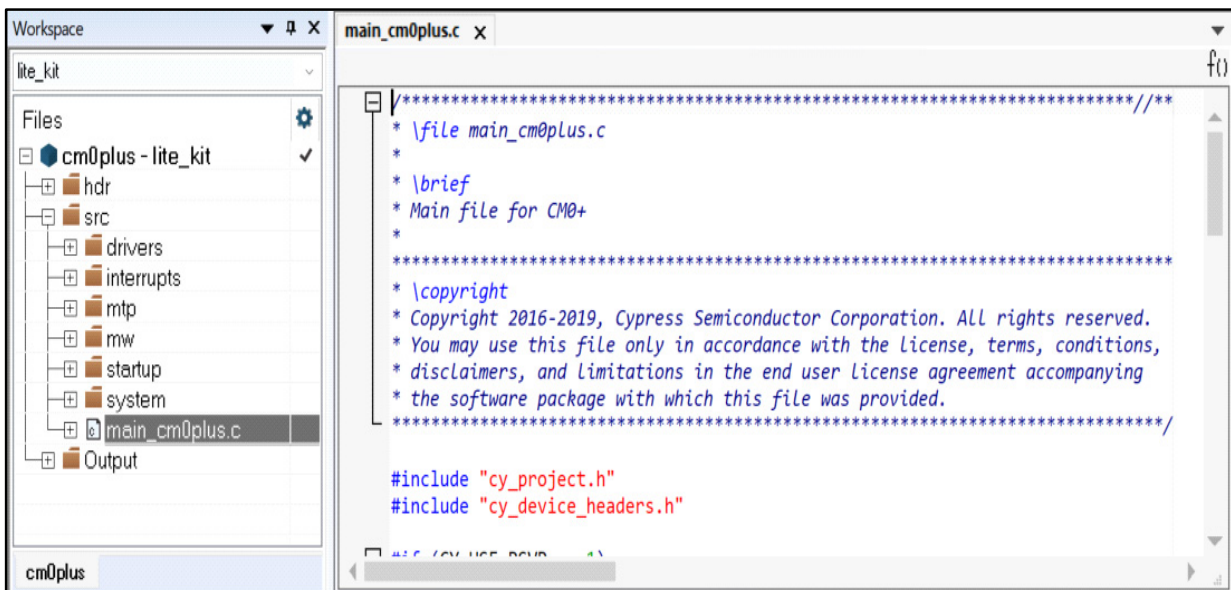

Figure 41 Opening main C file in IAR

Programming and debugging

- For checking the debugger option, right-click on the "cm0plus - lite_kit" and select "Options", and then "Debugger". Check what is selected in the driver menu in the Debugger tab. If you are using the I-JET debugger, then select "I-jet" or if you are using the KitProg USB-UART bridge, then you can use the "CMSIS DAP" option there. Since this example uses the I-jet debugger, select the "I-jet" option and press **OK**.

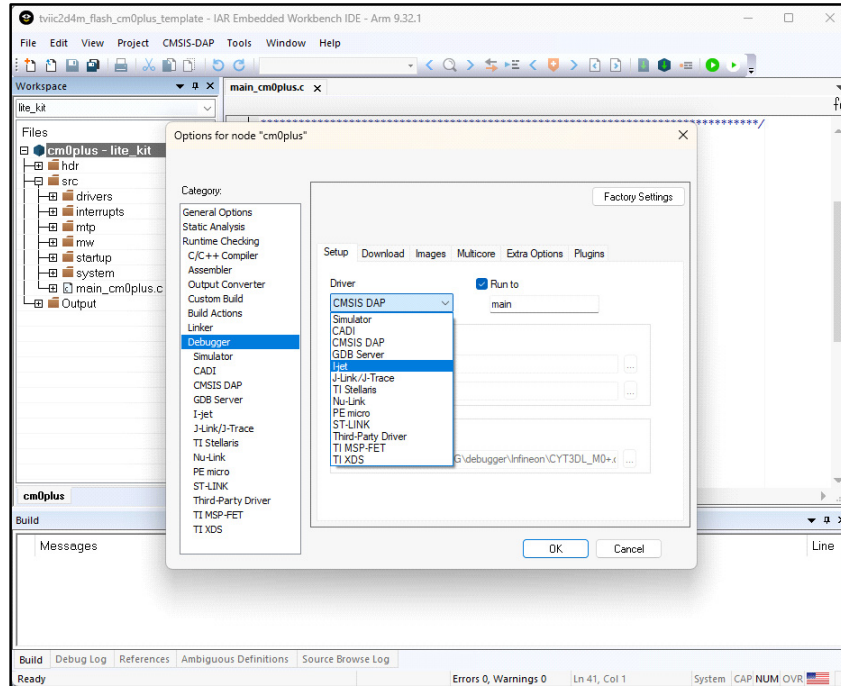

Figure 42 Checking the debugger option in IAR

- For the build, right-click on the "cm0plus - lite_kit" and select the "Rebuild All" option.

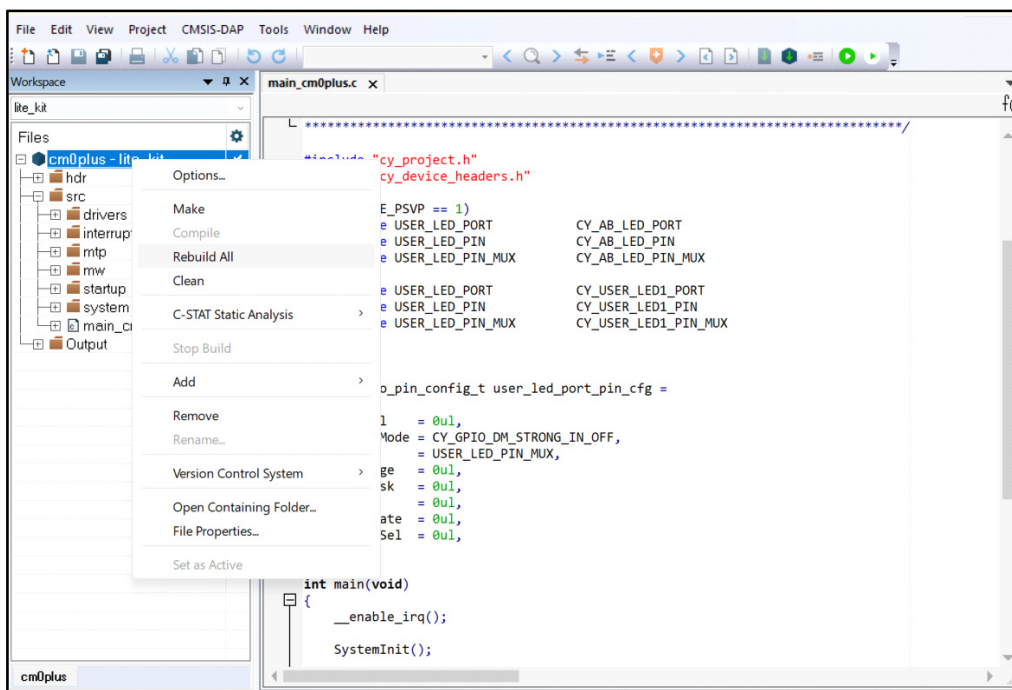

Figure 43 Compiling and building the code in IAR

Programming and debugging

6. Now the rebuild process starts; you can check for errors and warnings in the "Build Log".

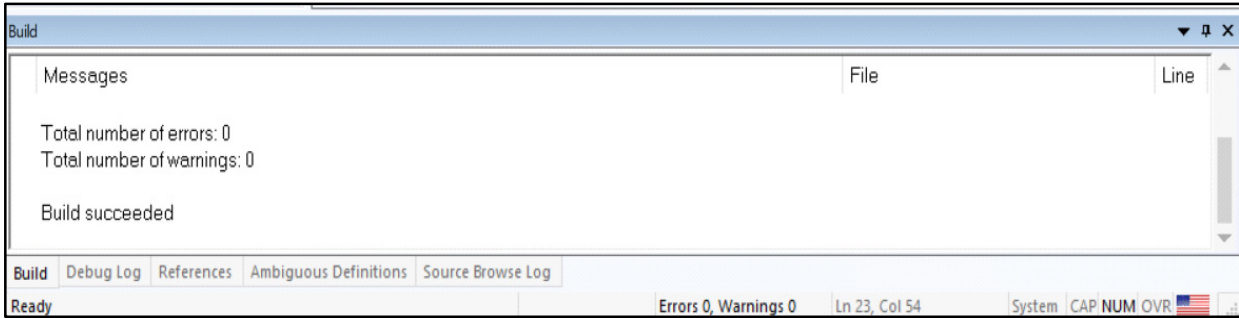

Figure 44 Checking for errors and warnings in build log in IAR

Note: If the build window does not appear on the screen, go to "View > Messages > Build". In the Messages option under View, you can find the debug log, reference windows etc.

7. To load the program to the flash region of CM0+ core, click the "Download and Debug" icon in the toolbar.

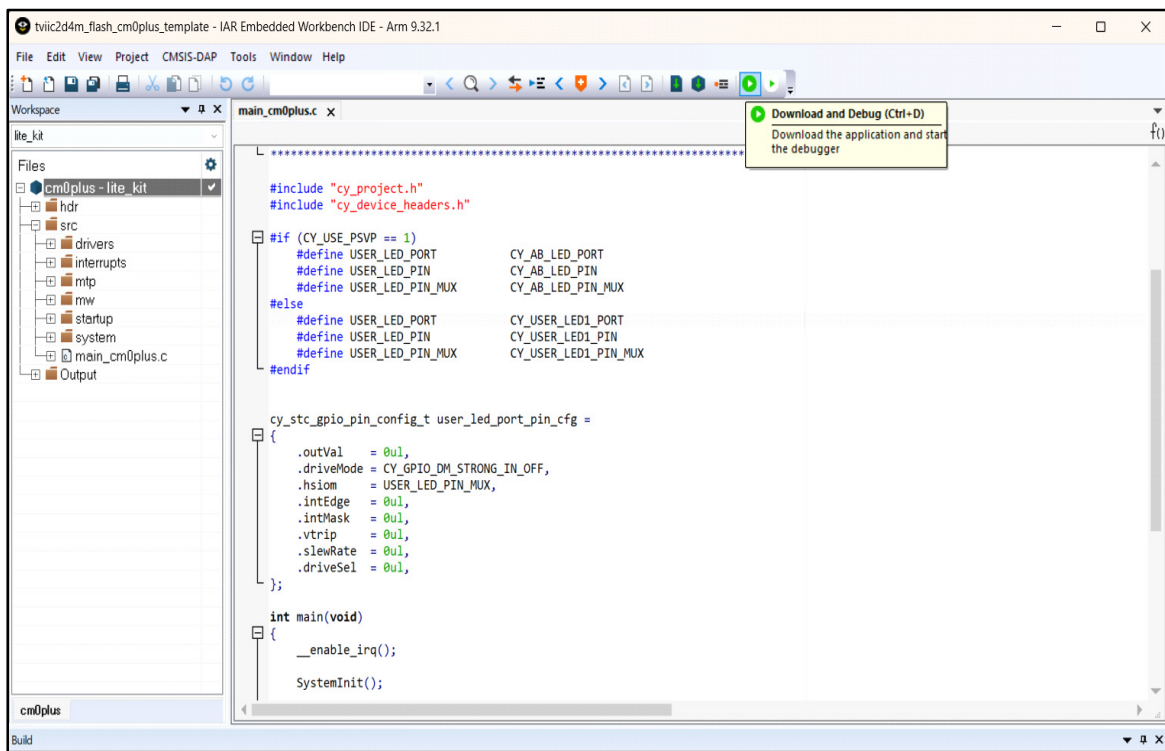

Figure 45 Downloading and debugging the code in IAR workspace

Programming and debugging

- Now click the "Go" icon to start the execution. You can also use the function keys in the Debug window: F5 (Go), F10 (Step Over), F11 (Step into), and Ctrl+D (Download and Debug).

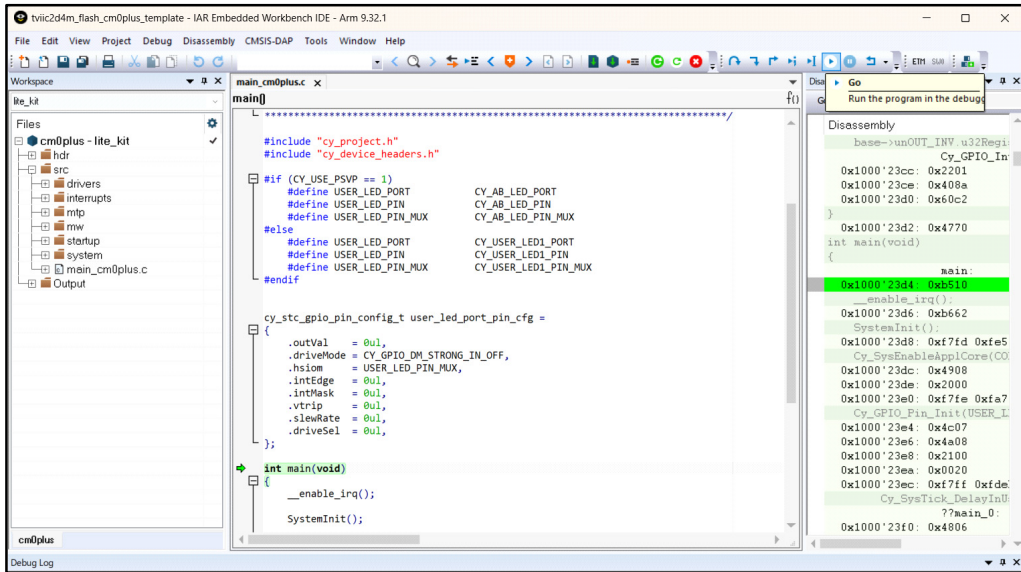

Figure 46 Running the code in IAR workspace for TRAVEO™ T2G Cluster 4M Lite kit

- In free-running execution, user LED1 (D900) starts blinking on the board.

4.3 Program and debug CYT3DL device using KitProg3

To program and debug this kit using KitProg3, connect the Micro-B cable between X400 and USB port of the PC. After connecting the Micro-B cable, follow the same steps as mentioned in [Section 4.2](#). The other steps are identical, except the debugger option and connection, which will change. In the "debugger option", select "CMSIS DAP" since it is supported by the KitProg3 USB-UART bridge to flash the code and debugging.

[Figure 47](#) shows the connection of the Micro-B cable between jumper X400 and the USB port of the PC.

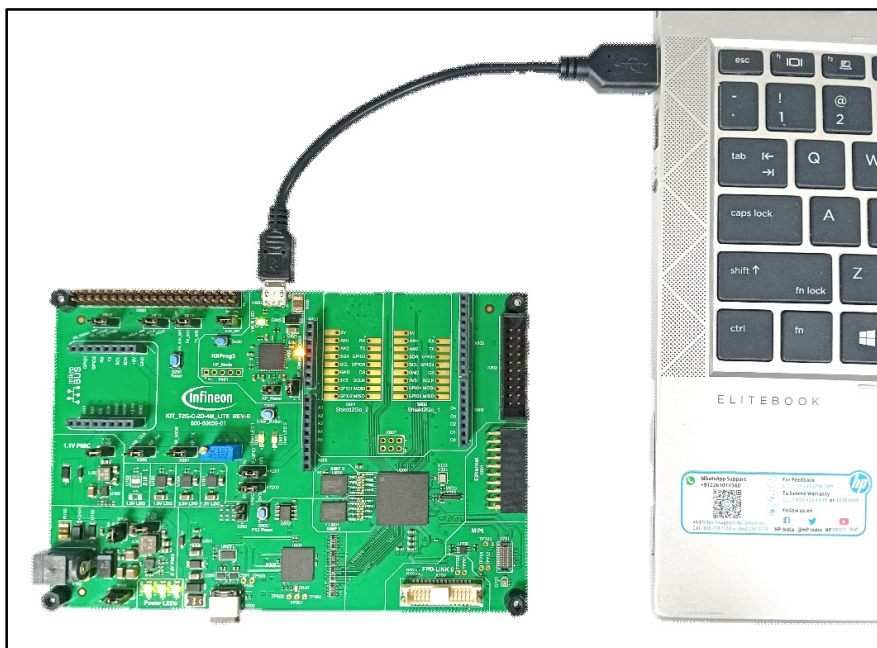

Figure 47 Connecting USB Micro-B cable between X400 and USB port of PC

Programming and debugging

4.4 Program EZ-USB™ FX3

Follow the procedure mentioned in this section to program the EZ-USB™ FX3. But before that, download the software required to program EZ-USB™ FX3. To program and use the EZ-USB™ FX3, use the FX3 Software development Kit (FX3 SDK), which comes with tools, drivers, and application example.

Note: Refer to [References](#) at the end of this document for downloading the FX3 SDK.

Follow these steps to program EZ-USB™ FX3:

- Install the EZ-USB™ FX3 SDK in your PC for drivers and programming tools.
- Program the EZ-USB™ FX3 through the Control Center.

Follow these steps to install the EZ-USB™ FX3 SDK in your PC for drivers and programming tools

1. Download the EZ-USB™ FX3 SDK.
2. After downloading it from the web, unzip it and open FX3SDKSetup application.
3. In the Installation type tab in the SDK window, select the option you prefer (in this example, the "Custom" option is selected), and then click **Next**.

In the "Selected Release" table, do not select/deselect or change anything. Follow the default setup and click **Next**.

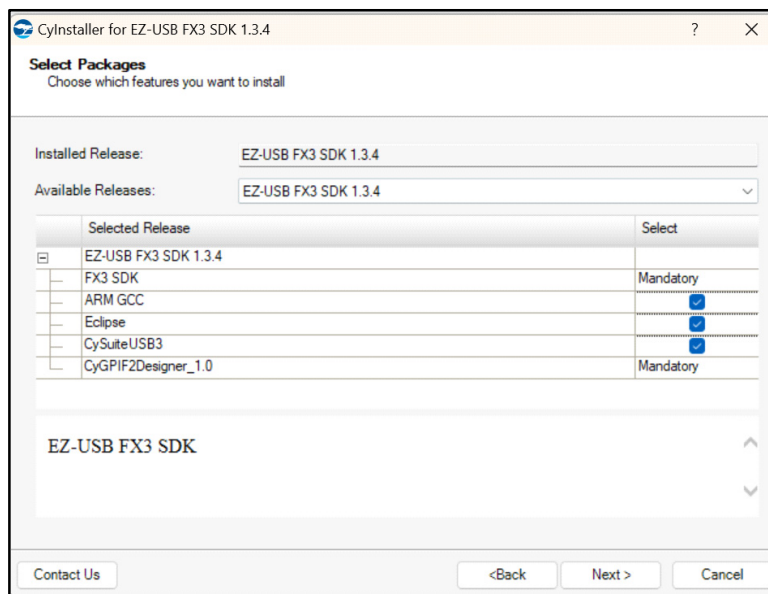

Figure 48 Installing FX3 SDK in PC

4. Click on "Accept the terms and conditions" and after reading that carefully, click **Next**.
5. Follow the same process for the next steps and wait until the window shows you the installation status.
6. After installation is complete, a window with "Contact Information" pops up; fill that and click **Finish**.
7. Your FX3 SDK installation is complete.

Programming and debugging

Programming FX3 through control center

1. Before programming the FX3, make sure that you connect the jumper X502 on board, to enable FX3 to move to Bootloader mode. Now press the FX3 Reset button (S500) on the board.

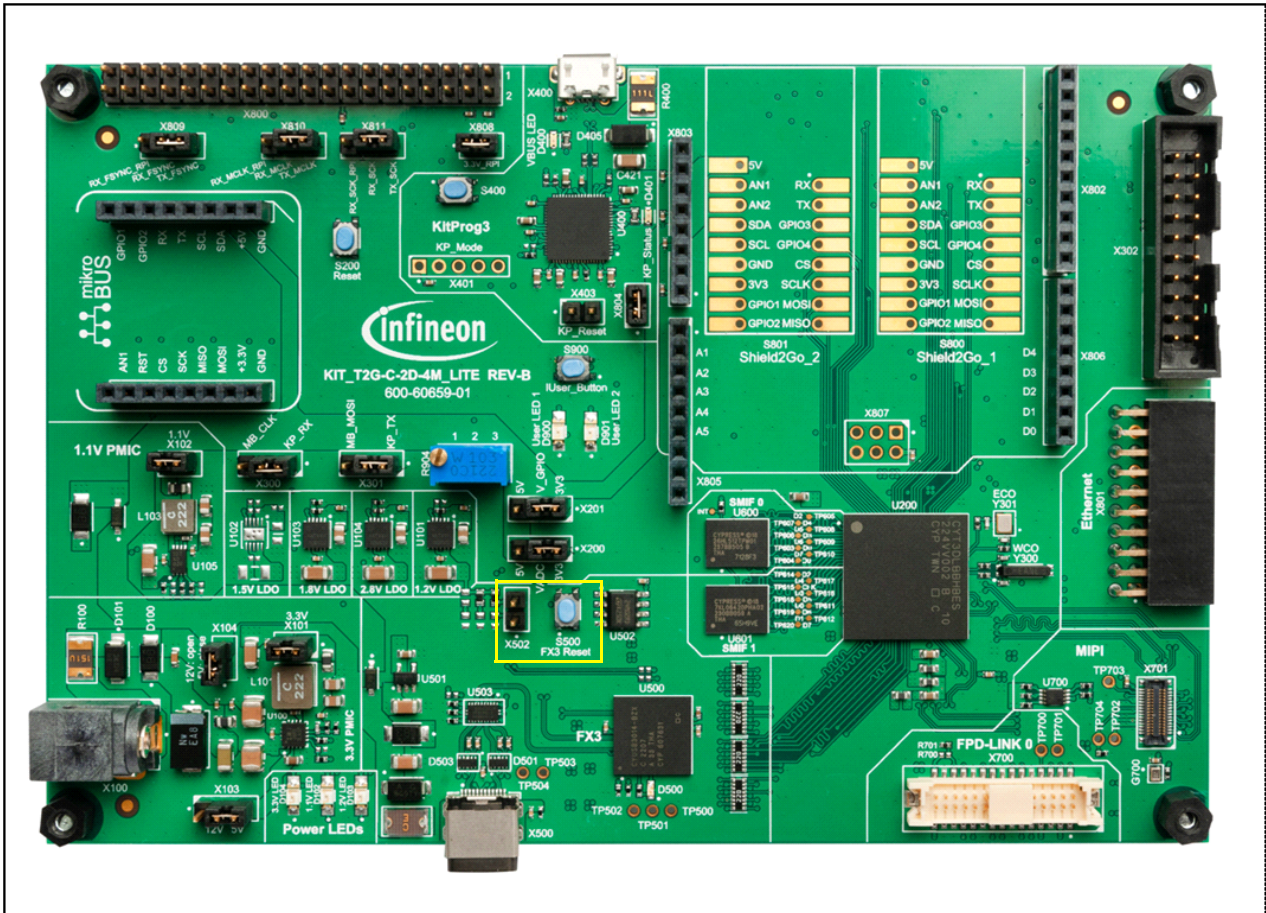

Figure 49 Shorting the jumper X502 and press reset button in TRAVEO™ T2G Cluster 4M Lite kit

2. Now connect the USB Type-C cable between the USB connector X500 on board and the USB port of your PC (do not power the board with a 12-V DC adapter or USB Micro-B for programming FX3; the Type-C connector is capable of powering it through USB port of your PC).
3. Open the search tab and search for "Control Center". If you cannot find it, go to **Start > All apps > Cypress**, and open it.

Programming and debugging

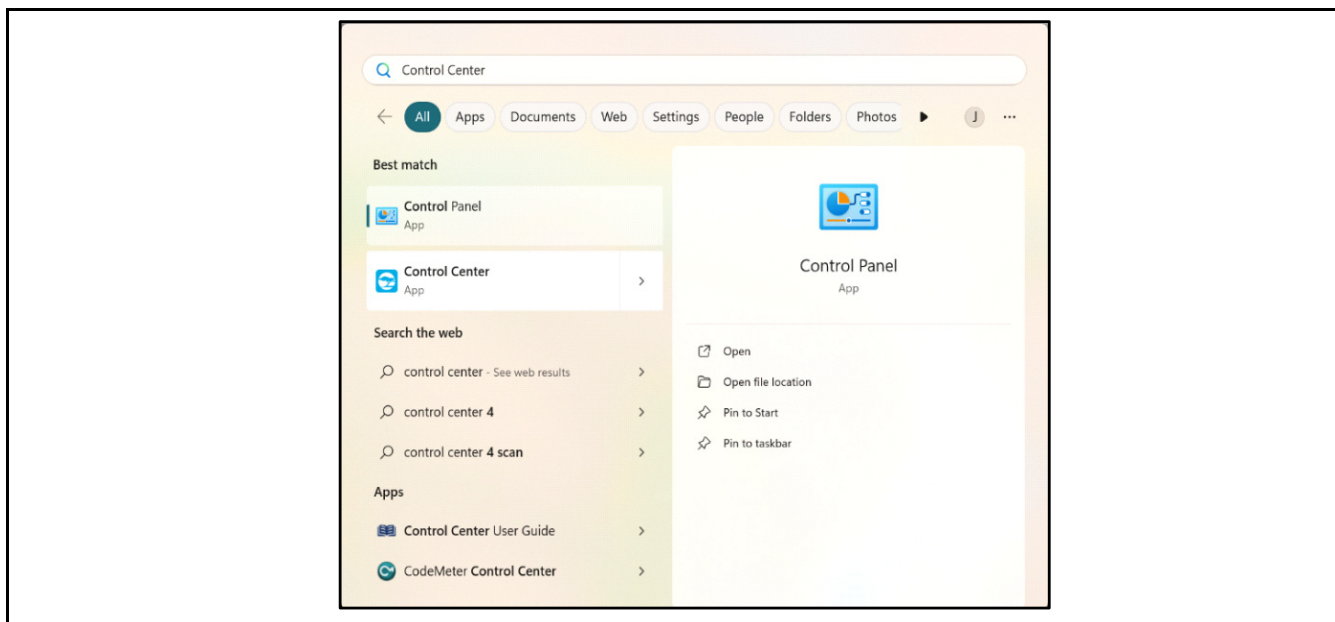

Figure 50 Opening Control Center for programming FX3

4. Select "Cypress FX3 USB Bootloader Device" in the Control Center. Next, go to **Program** > **FX3**, and select "I2C EEPROM".

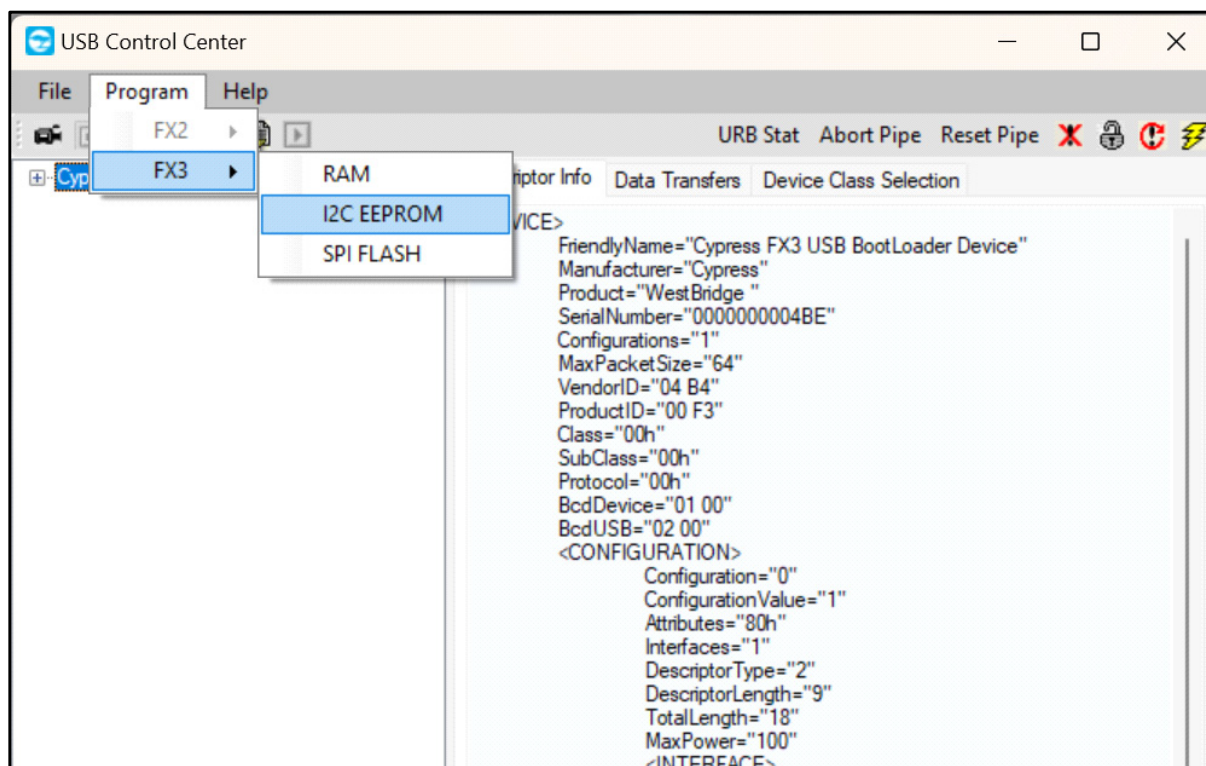

Figure 51 Programming EZ-USB™ FX3

Programming and debugging

- 5. Now, you will be prompted for the location of the UVC image to flash into FX3. Locate the directory that has the image file which you want to program. After selecting that image in the bottom left of the Control Center, note the status of the flashing.

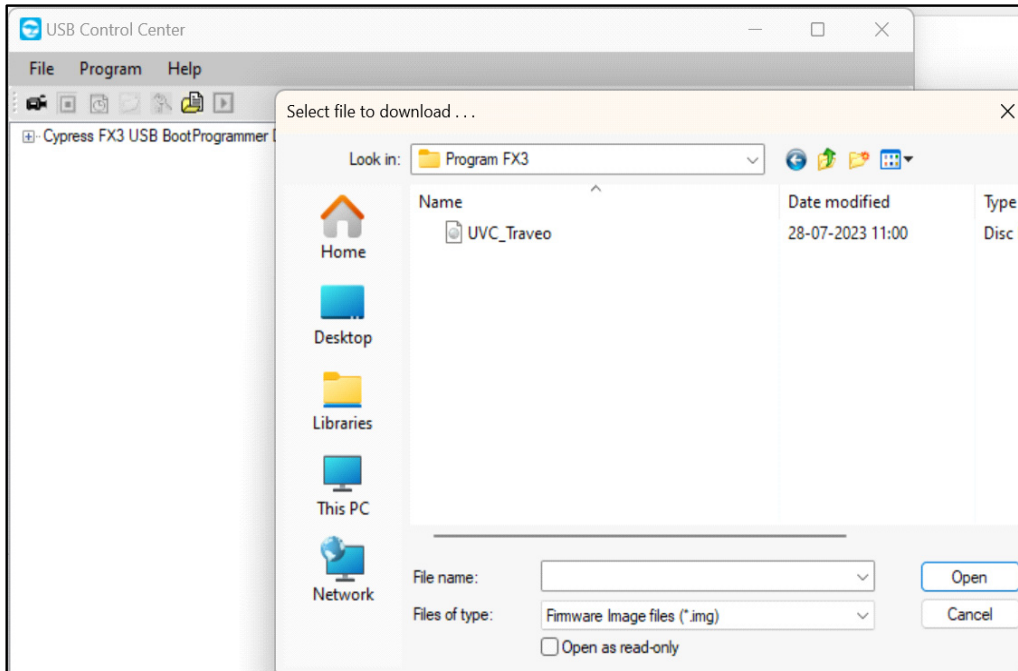

Figure 52 Flashing UVC image into FX3

- 6. If the status shows “Programming of I2C EEPROM Succeeded”, the FX3 is programmed. You can close the Control Center tab now and remove the X502 jumper from the kit.

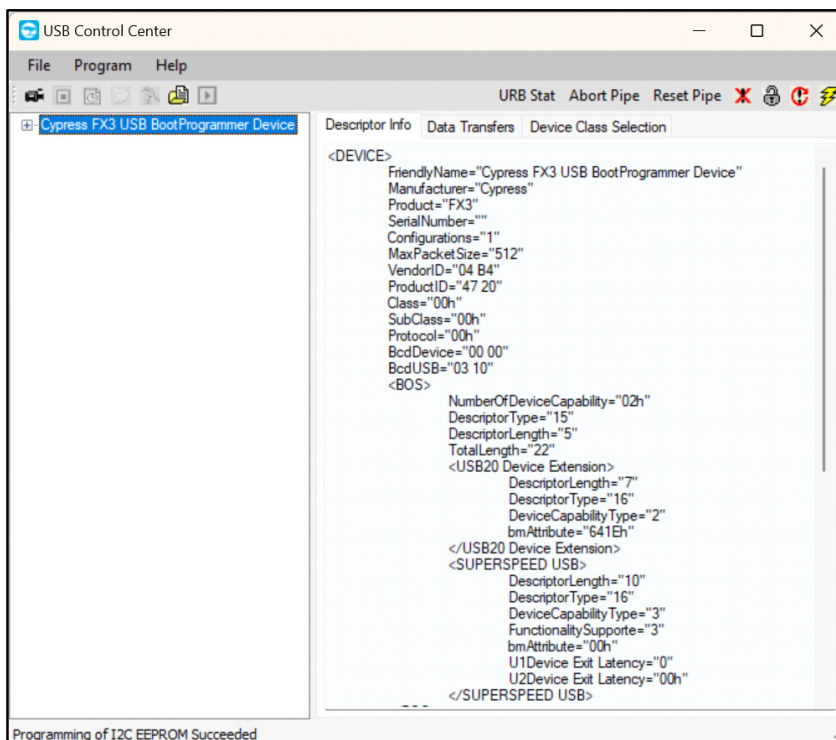

Figure 53 Programming of FX3 is done

Programming and debugging

Attention: *If you have connected the X502 jumper on your board, then note the device “Cypress FX3 USB Boot Programmer Device” under the “Universal Serial Bus controllers” tab in the Device Manager, as shown in Figure 54.*

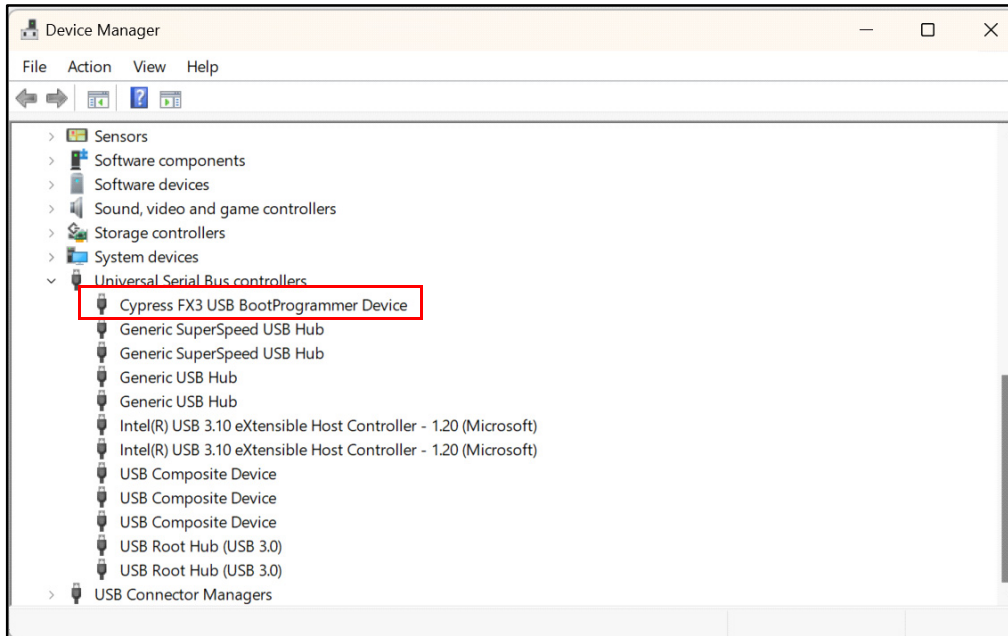

Figure 54 EZ-USB™ FX3 coming under Universal Serial Bus Controllers

Attention: *If you removed the X502 jumper from your board, note the “FX3” device under “Camera” in the Device Manager, as shown in Figure 55. Before or after removing the X502 jumper, disconnect and connect the power in the kit again to see them in the device manager under these tabs.*

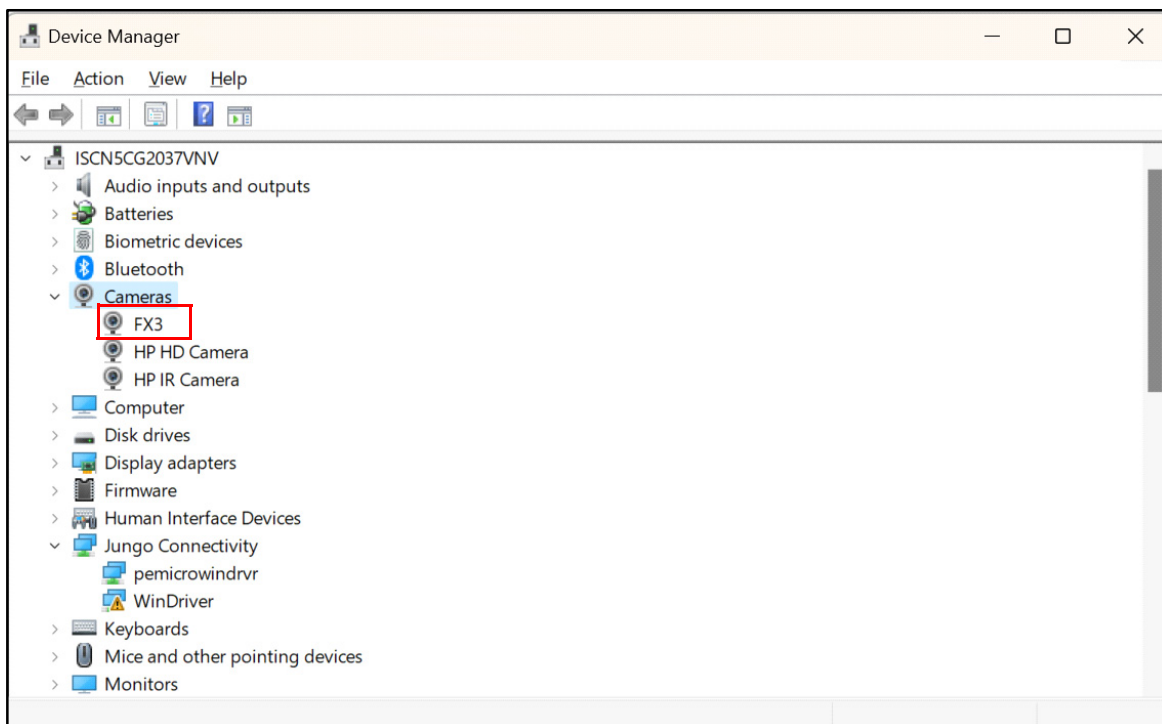

Figure 55 EZ-USB™ FX3 coming under Camera in Device Manager

Technical specifications

5 Technical specifications

5.1 Test points

The following table describes the test points available in this kit.

Table 13 Available test points available

Serial No.	Functionality	Reference designator
1	FX3 UART_RX	TP501
2	FX3 UART_TX	TP502
3	SMIF0 RWDS	TP600
4	SMIF0 CLK	TP602
5	SMIF0 DATA0	TP603
6	SMIF0 DATA1	TP604
7	SMIF0 DATA2	TP605
8	SMIF0 DATA3	TP606
9	SMIF0 DATA4	TP607
10	SMIF0 DATA5	TP608
11	SMIF0 DATA6	TP609
12	SMIF0 DATA7	TP610
13	SMIF1 DATA0	TP611
14	SMIF1 DATA1	TP612
15	SMIF1 SEL0	TP613
16	SMIF1 DATA2	TP614
17	SMIF1 CLK	TP615
18	SMIF1 DATA3	TP616
19	SMIF1 DATA4	TP617
20	SMIF1 DATA5	TP618
21	SMIF1 DATA6	TP619
22	SMIF1 DATA7	TP620
23	SMIF1 RWDS	TP621
24	SMIF0 SEL0	TP622

Technical specifications

5.2 Multiplexed options

In this kit, you can use any one functionality of some of the multiplexed pins, depending upon the jumpers or connections you made. Check the connection and jumpers before you decide the functionalities you need.

Table 14 Multiplexed options

Reference designator	Functionality	Jumper selection
X300	KitProg RX	1-2: short (default)
	mikroBUS SPI CLK	2-3: short
X301	KitProg TX	1-2: short (default)
	mikroBUS SPI MOSI	2-3: short
X809	TDM RX FSYNC going to RPi header	1-2: short
	TDM RX FSYNC to TX FSYNC	2-3: short (default)
X810	TDM RX MCLK going to RPi header	1-2: short
	TDM RX MCLK to TX MCLK	2-3: short (default)
X811	TDM RX SCK routed to RPi header	1-2: short
	TDM RX SCK to TX SCK	2-3: short (default)

Appendices

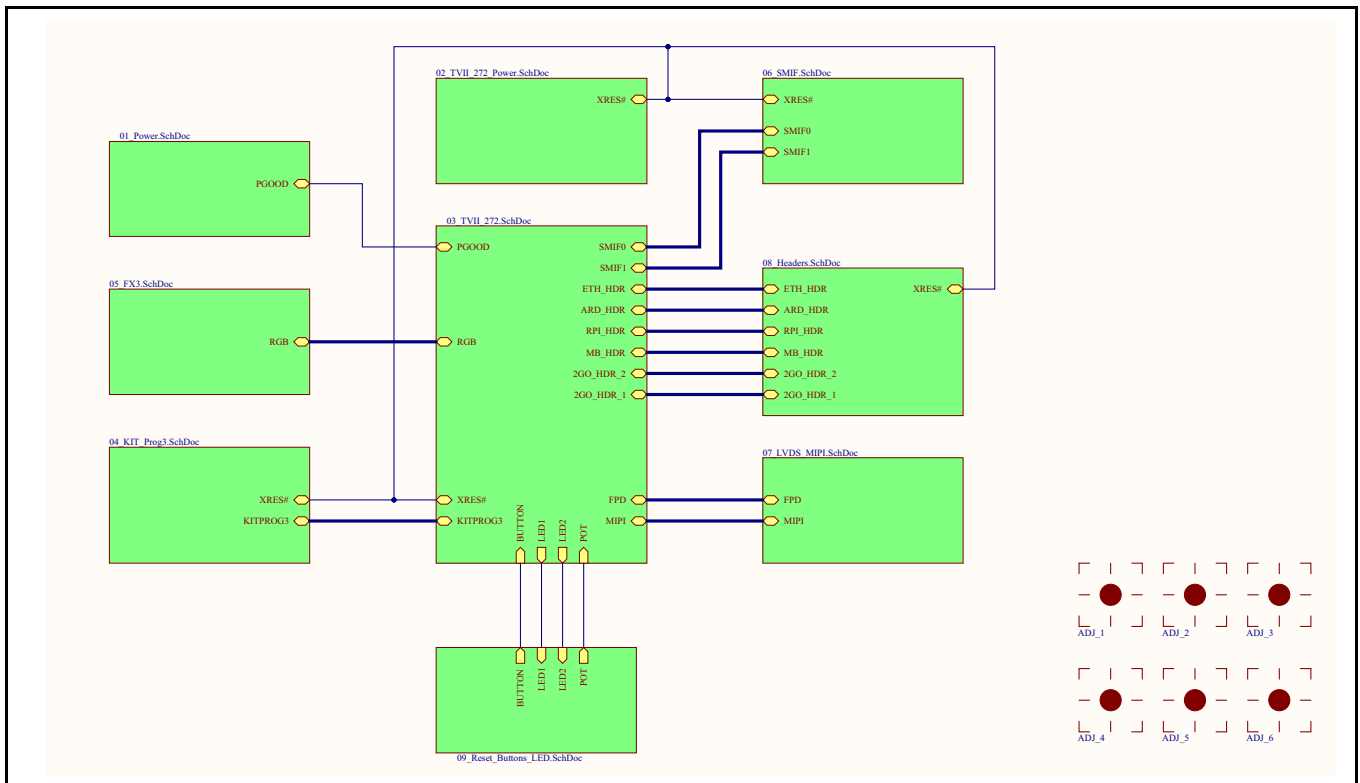

Figure 58 Overview page

Appendices

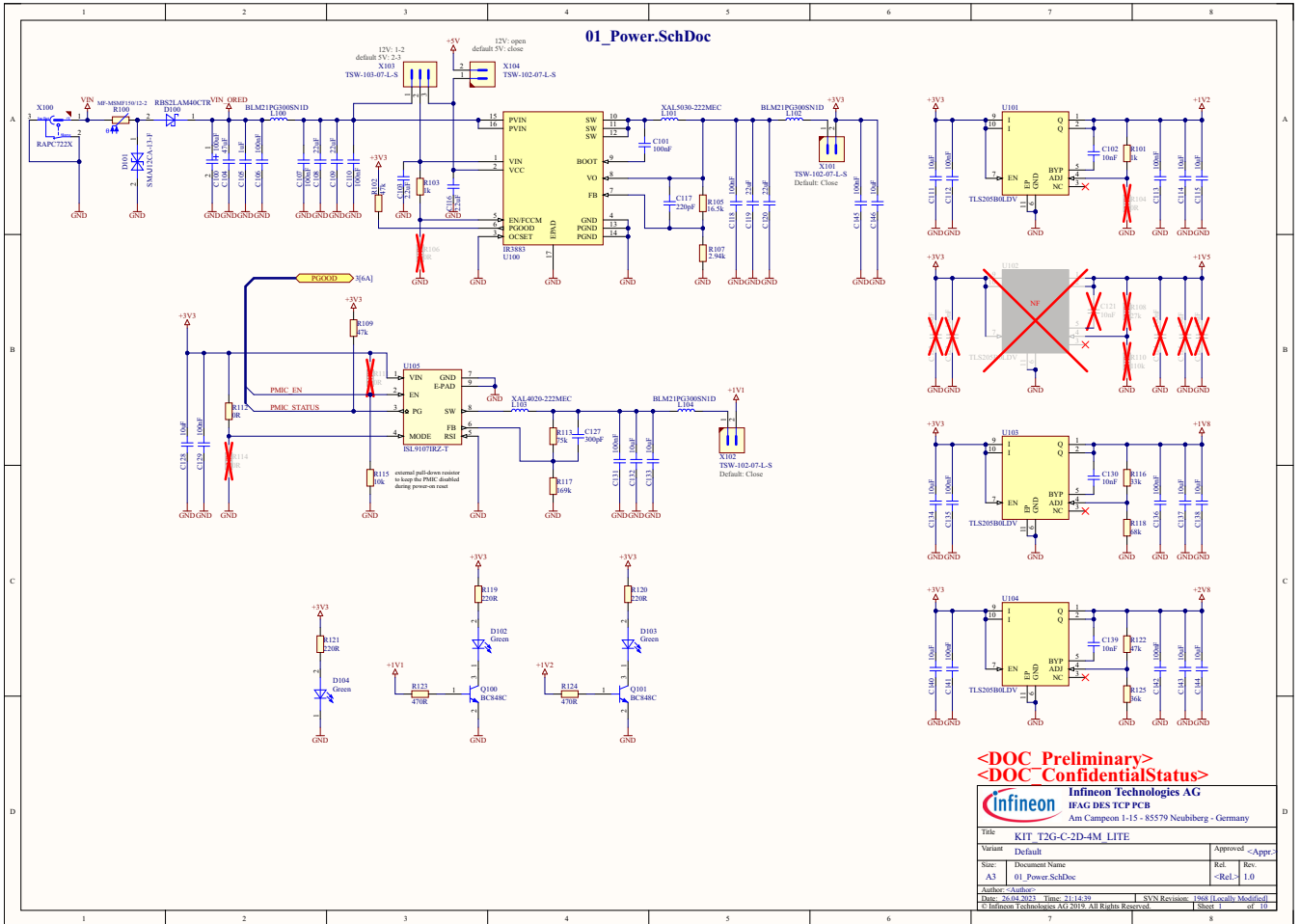

Figure 59 Board power page

Appendices

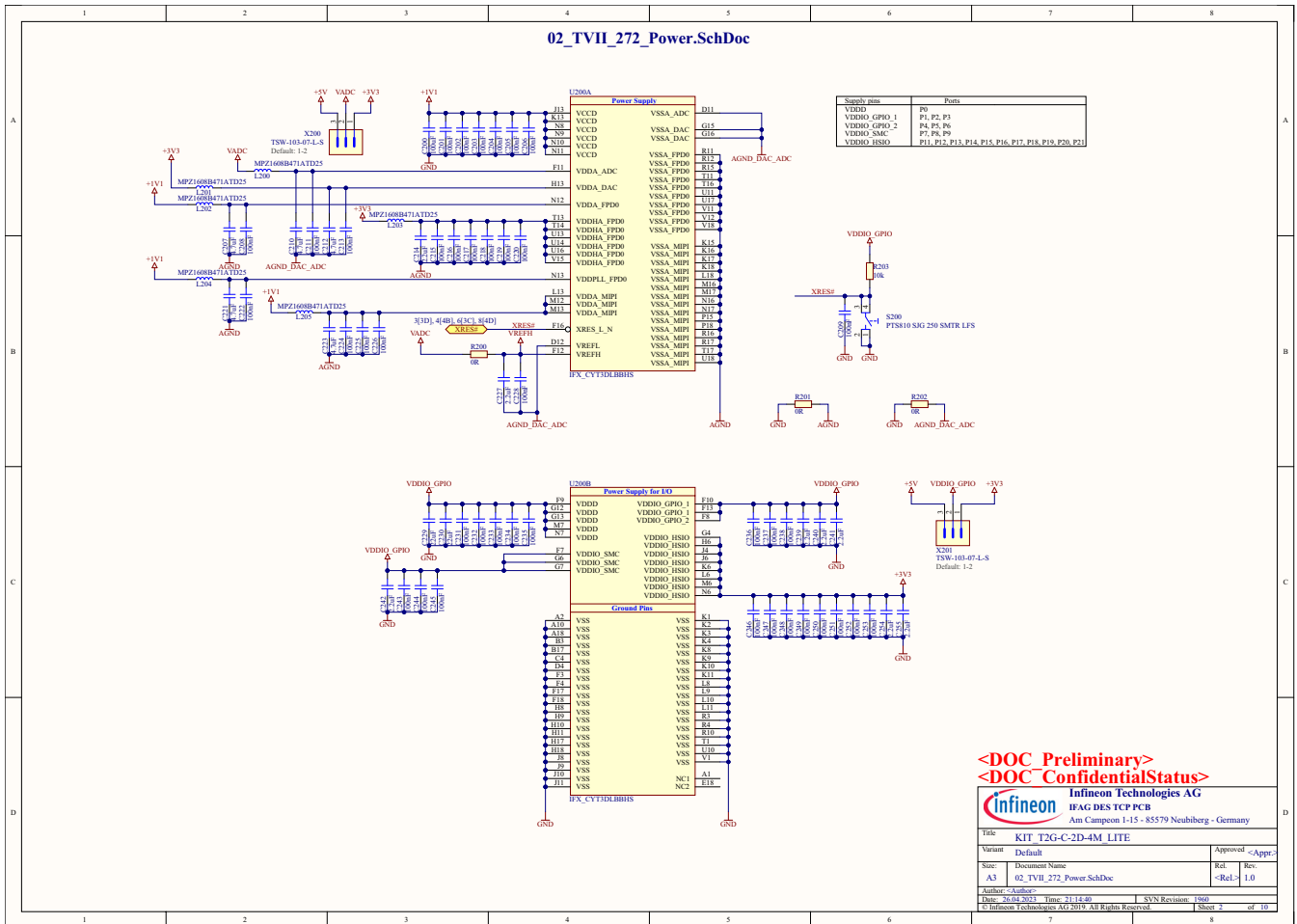

Figure 60 TVII-272 MCU power page

TRAVEO™ T2G Cluster 4M Lite Kit user guide

KIT_T2G_C-2D-4M_LITE



Appendices

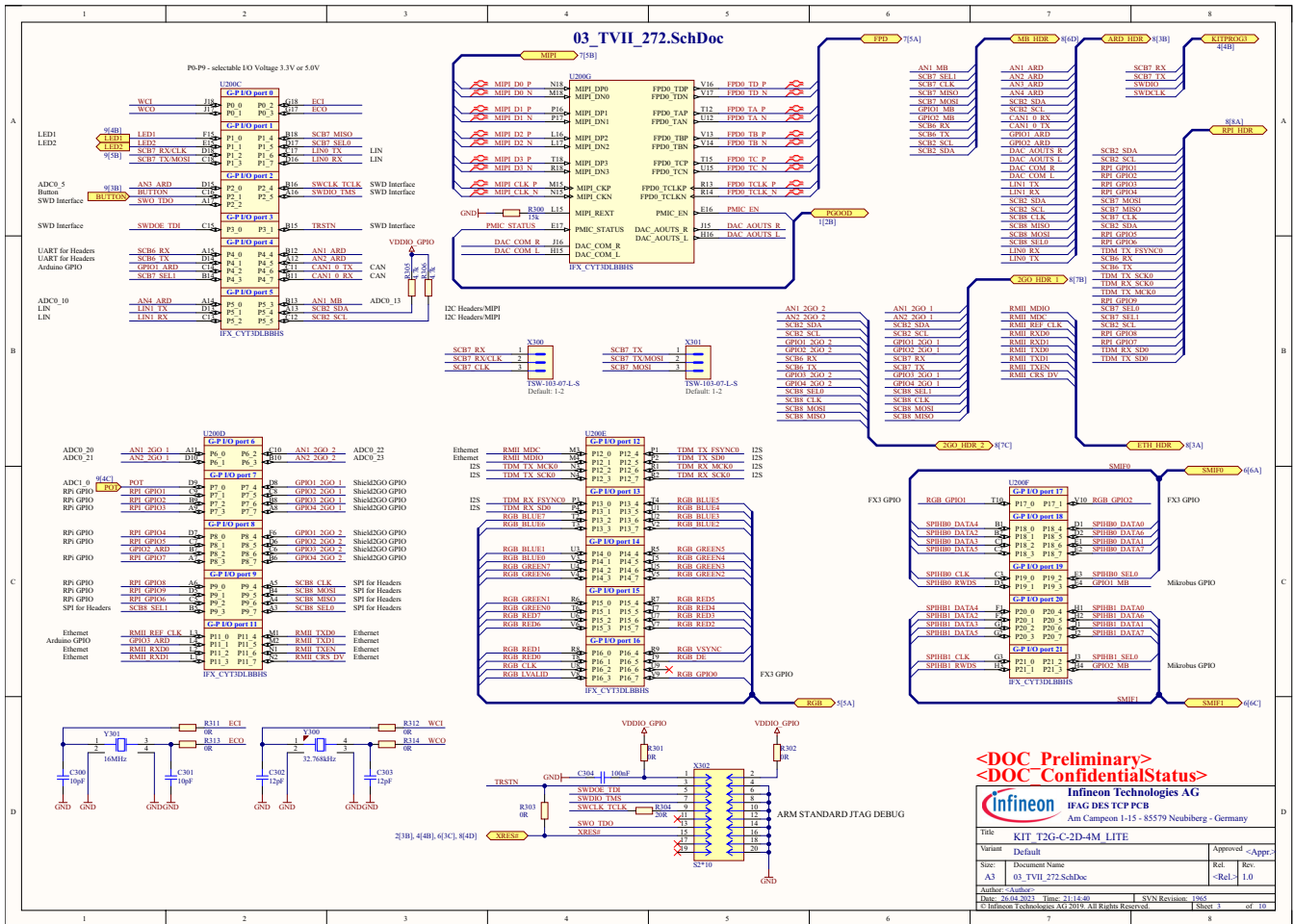

Figure 61 TV11-272 MCU schematic page

Appendices

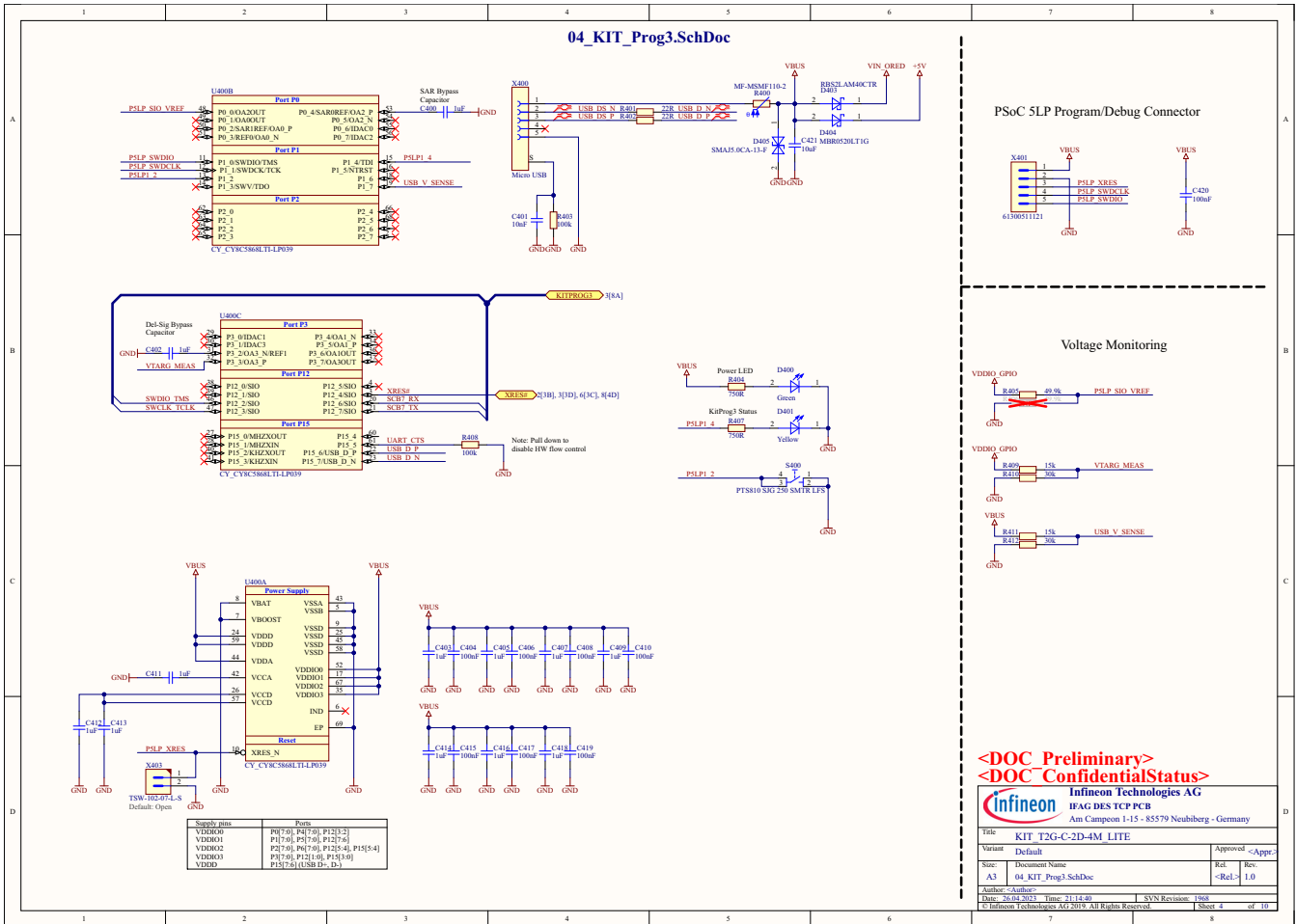

Figure 62 KitProg3 schematic page

Appendices

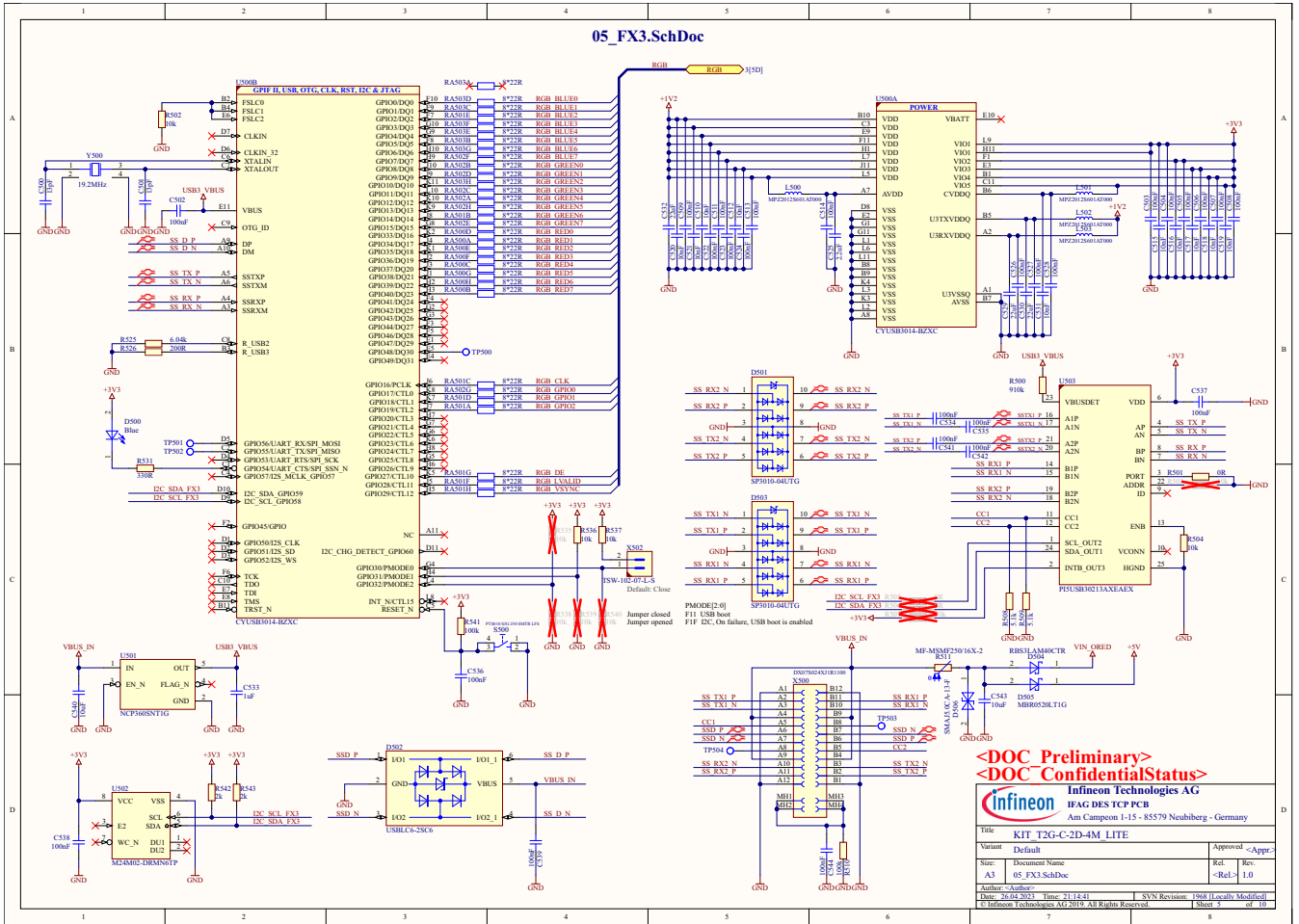
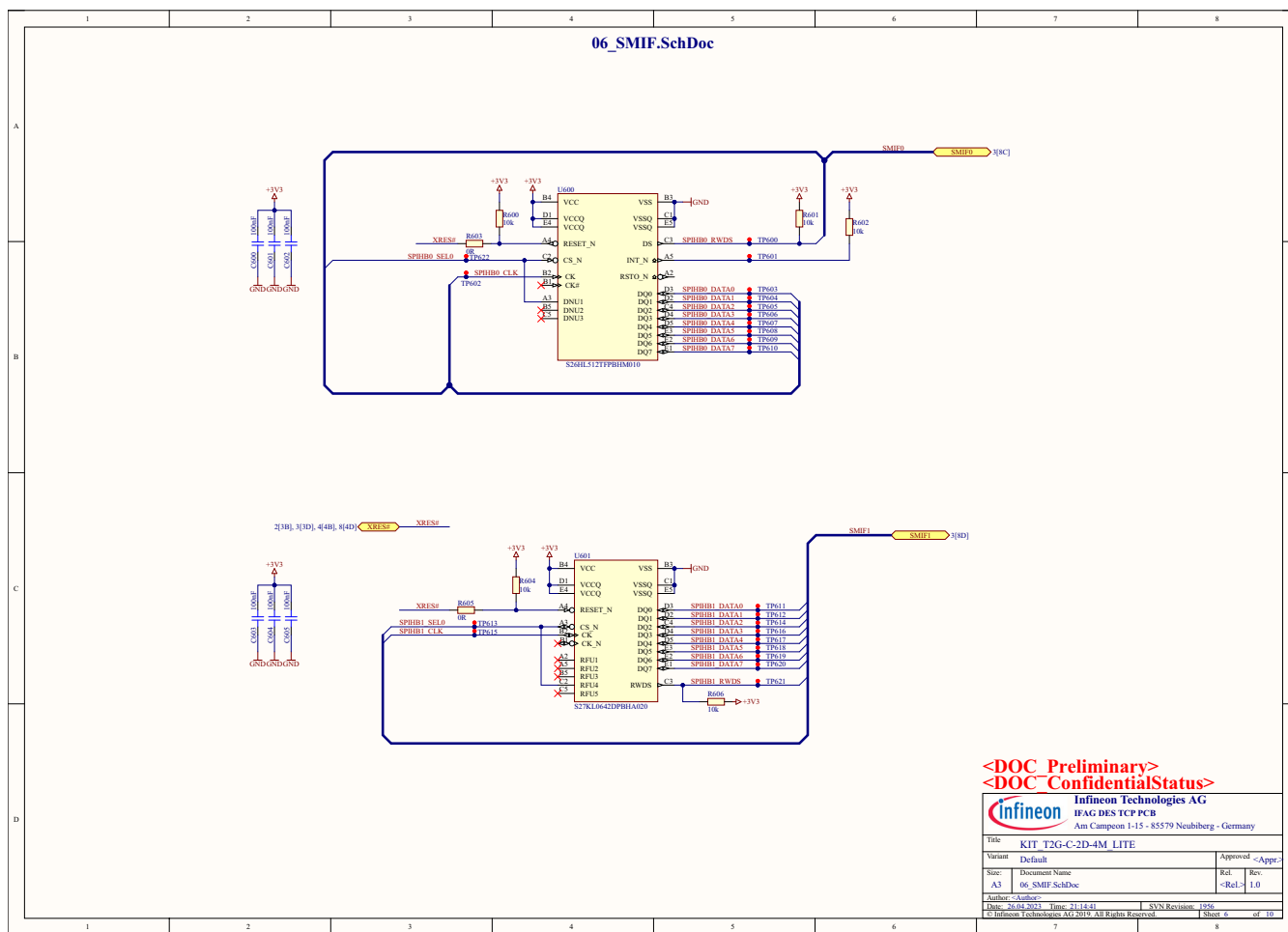

Figure 63 FX3 schematic page

Appendices



<DOC Preliminary>
<DOC ConfidentialStatus>

Infineon Technologies AG IFAG DES TCP PCB Am Campeon 1-15 - 85579 Neuberg - Germany	
Title: KIT_T2G-C-2D-4M_LITE	
Variant: Default	Approved: <Appr.>
Size: Document Name	Ref: Rev:
A3: 06_SMIF_SchDoc	<Rel.:> 1.0
Author: <Author> Date: 26.04.2023, Time: 21:14:41 SVN-Revision: 1256 © Infineon Technologies AG 2019. All Rights Reserved. Show 6 of 10	

Figure 64 Serial Memory interface schematic page

Appendices

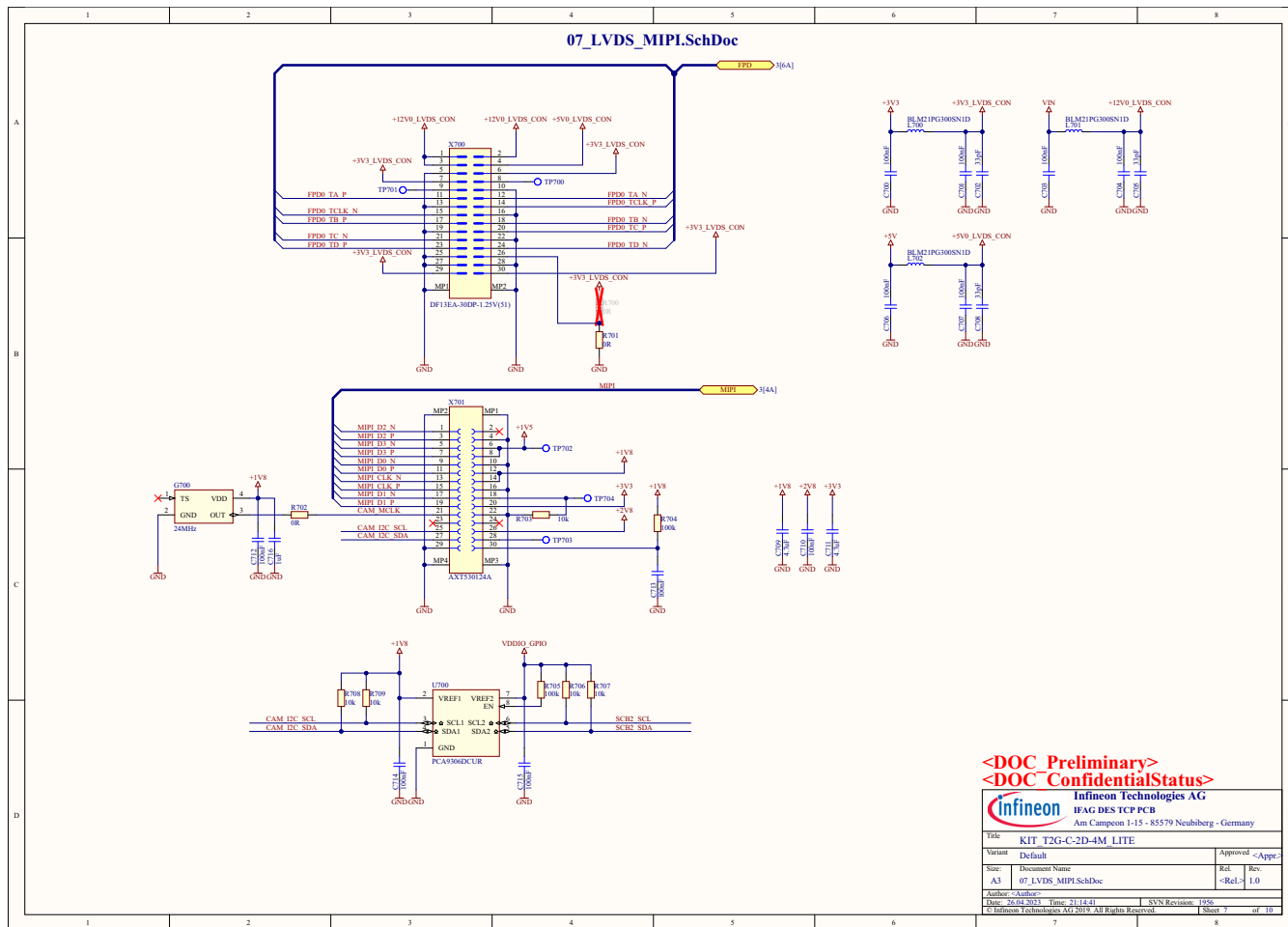

Figure 65 LVDS and MIPI schematic page

Appendices

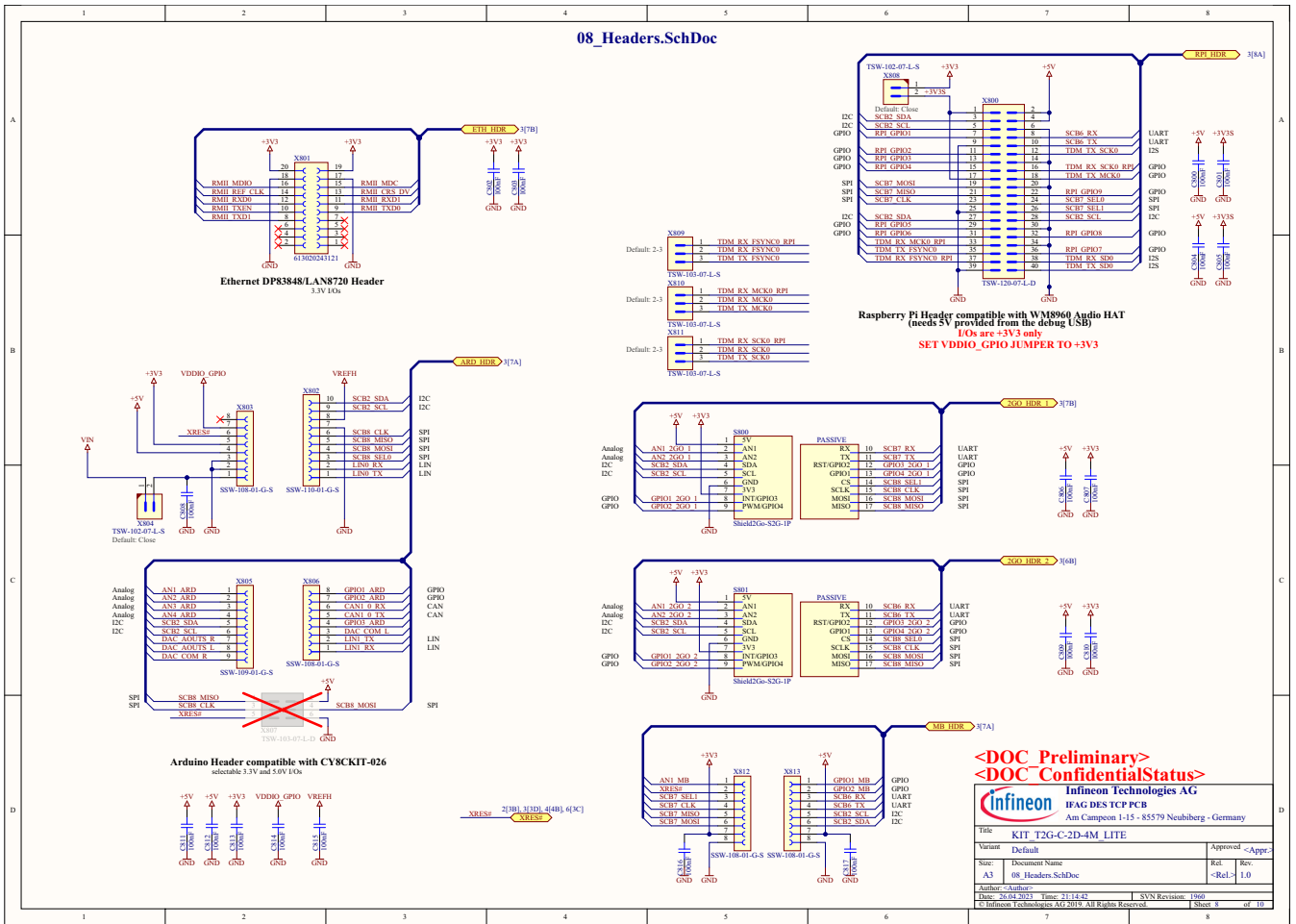

Figure 66 I/O headers schematic page

Appendices

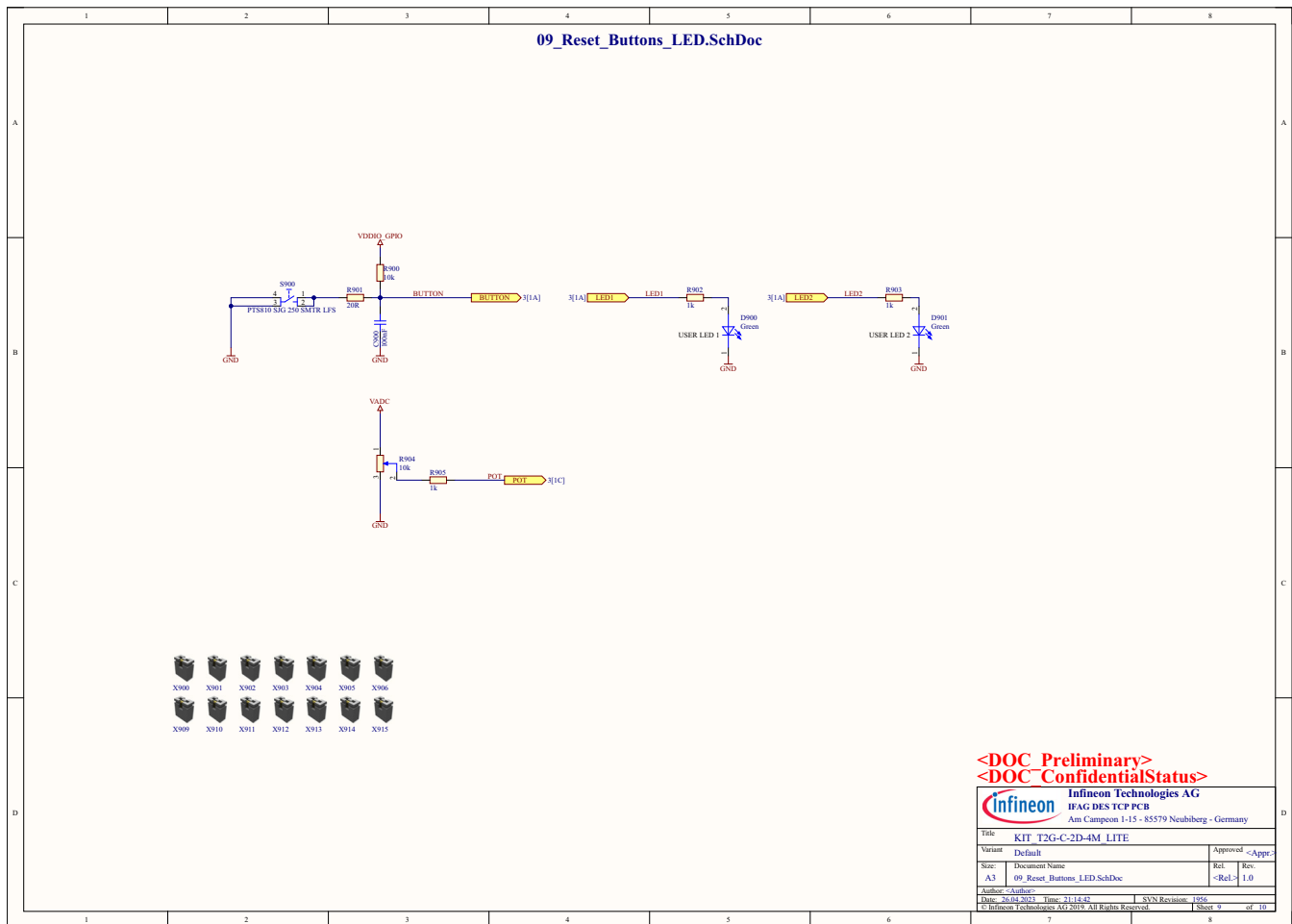

Figure 67 Reset button, LEDs, and potentiometer schematics page

Appendices

6.1.3 Assembly drawings

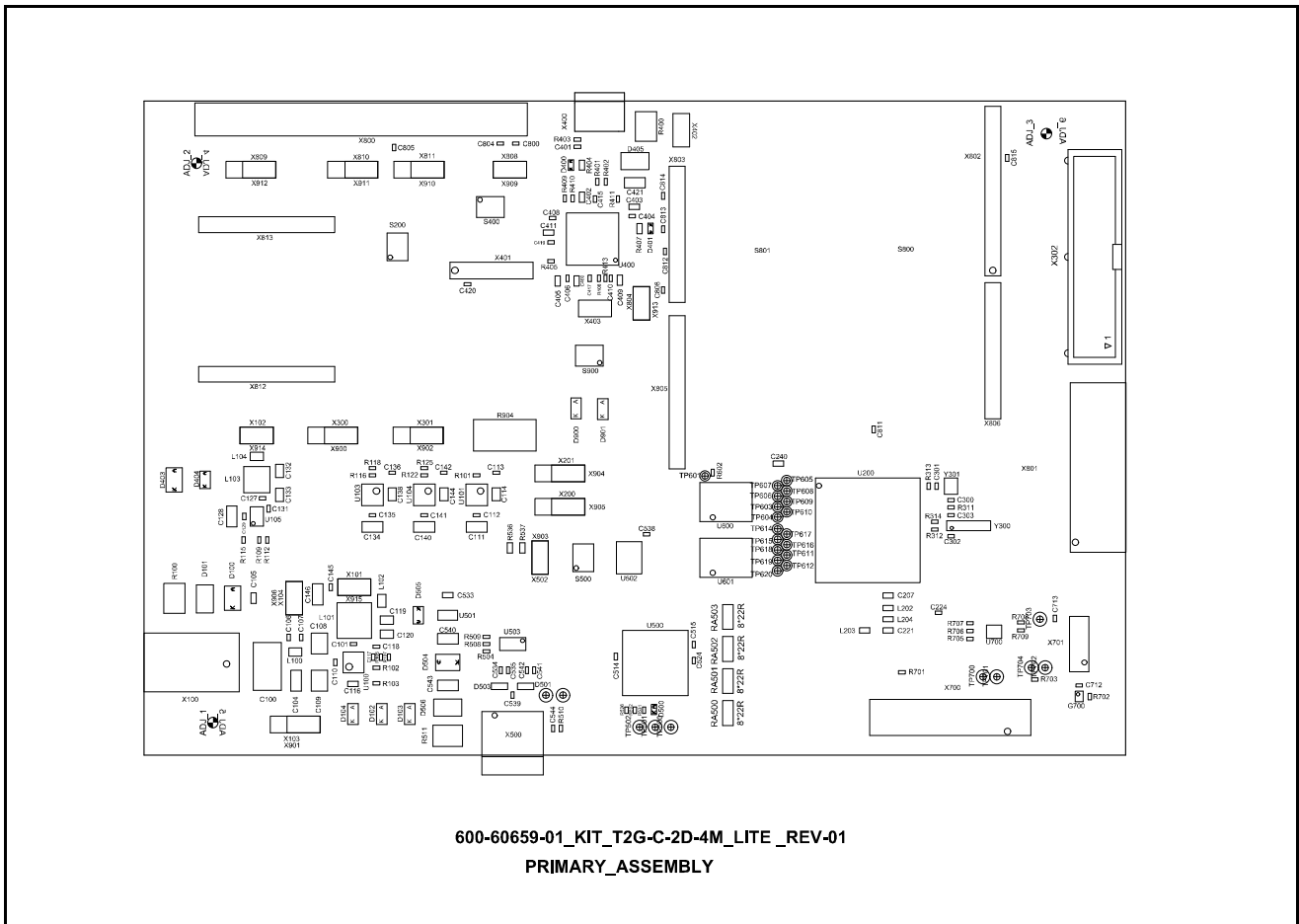

Figure 68 Primary assembly drawing of TRAVEO™ T2G Cluster 4M Lite kit

Appendices

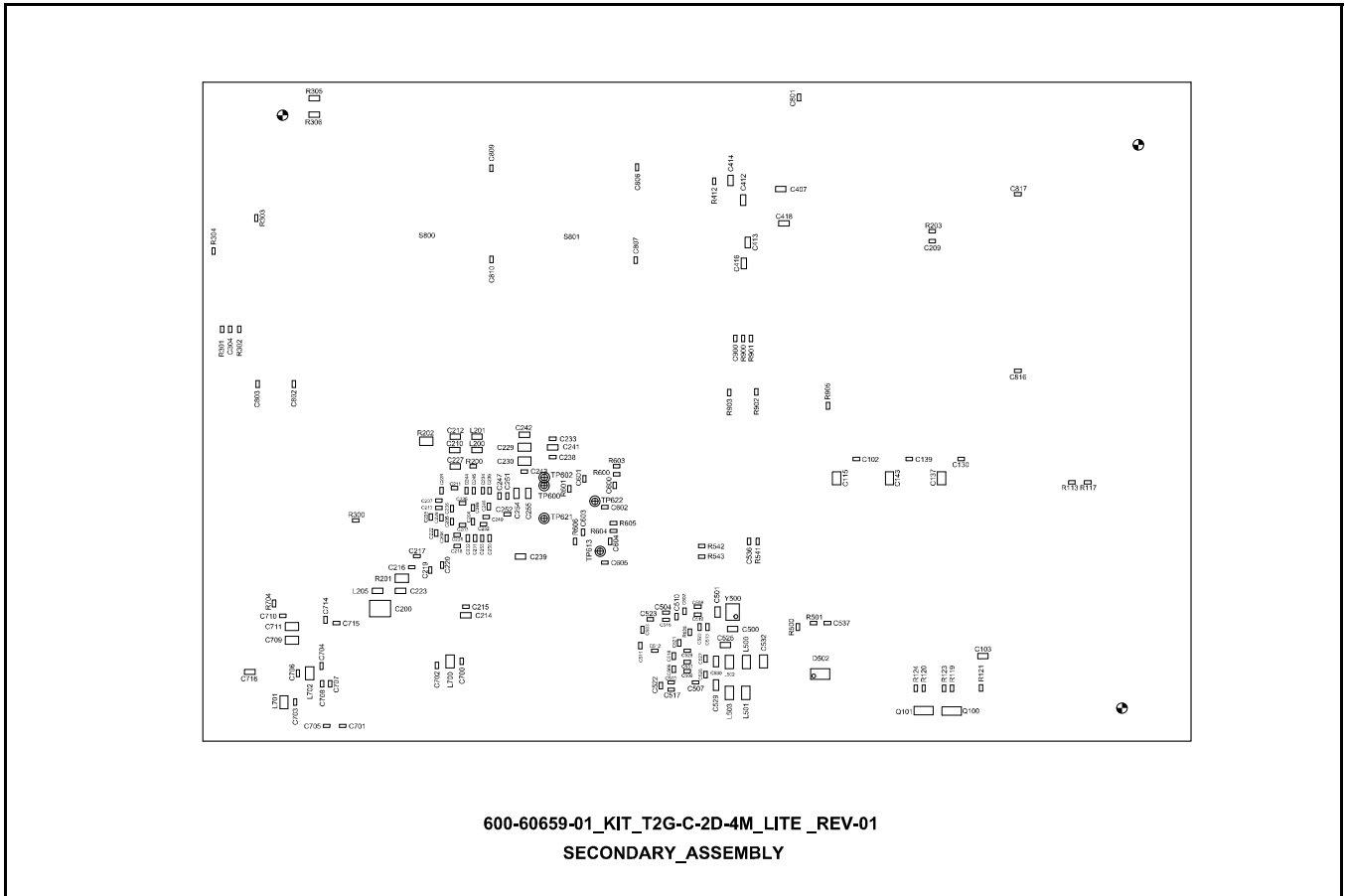

Figure 69 Secondary assembly drawing of TRAVEO™ T2G Cluster 4M Lite kit

Appendices

6.2 Bill of material

The complete bill of material is available in the download section of the Infineon home page. A log-in is required to download this material.

Table 15 BOM of the critical parts of the evaluation or reference board (example)

S No.	Reference designator	Item name	Description
1		Printed Circuit Assembly	ASSY, PCBA, KIT_T2G_C-2D-4M_LITE
2	U501	Miscellaneous	IC, USB, POSITIVE OVER VOLTAGE/CURRENT PROTECTION, 5PIN, TSOP
3	U502	EEPROM	EEPROM, IC, 2MBIT, 1MHZ, 8PIN, SOIC
4	D502	Miscellaneous	IC, ESD, 6V, 2LINE, 6PIN, SOT-23
5	U601	Cypress	IC, INFINEON, PSRAM, 3.0V, 64Mbit, 166MHz, FBGA24
6	U503	Miscellaneous	Type-C Dual Role Port Controller with USB3.1 Gen1.5Gbps Mux
7	U700	ICPR	IC, TRANSLATOR, BIDIRECTIONAL, 8VSSOP
8	U105	Regulator, Switching	IC, REG, BUCK, 1.6MHz, 2.7V-5.5V, 0.8V-5.5V, 1.5A, 8-VFDF
9	R403,R408,R510,R541,R704,R705	Fixed Resistor	RES, 100K OHM, 1%, 100PPM, 1/16W, 0402
10	R525	Fixed Resistor	RES, 6.04K OHM, 1%, 100PPM, 1/10W, 0402, SMD
11	R401,R402	Fixed Resistor	RES, 22 OHM, 1%, 100PPM, 1/16W, 0402
12	R405	Resistor	RES, 49.9K OHM, 1%, 100PPM, 1/16W, 0402, SMD
13	R101,R905,R103,R902,R903	Resistor	RES, 1K OHM, 1%, 100PPM, 1/16W, 0402, SMD
14	R113	Fixed Resistor	RES, 75K OHM, 1%, 100PPM, 1/16W, 0402, SMD
15	R201,R202	Resistor	RES, 0.0 OHM, 1/8W, 0805, SMD
16	R305,R306	Resistor	RES, 4.7K OHM, 1%, 100PPM, 1/10W, 0603, SMD
17	R536,R537	Resistor	RES, 10K OHM, 1%, 100PPM, 1/10W, 0603, SMD
18	R112, R200, R301, R302, R303, R311, R312, R313, R314,R413, R501, R603, R605,R702	Resistor	RES, 0.0 OHM, JUMP, 1/16W, 0402, SMD
19	R526	Resistor	RES, 200 OHM, 1%, 1/10W, 0402, SMD
20	R531	Resistor	RES, 330 OHM, 1%, 1/16W, 0402, SMD
21	R123,R124	Resistor	RES, 470 OHM, 5%, 1/10W, 0402, SMD
22	R116	Resistor	RES, 33K OHM, 1%, 0402, 1/16W
23	R410,R412	Resistor	RES, 30K OHM, 1%, 1/16W, 0402, SMD

Appendices

Table 15 BOM of the critical parts of the evaluation or reference board (example) (continued)

S No.	Reference designator	Item name	Description
24	R508,R509	Resistor	RES, 5.1K OHM, 1%, 1/16W, 0402, SMD
25	R125	Resistor	RES, 36K OHM, 1%, 1/16W, 0402, SMD
26	R300,R409,R411	Resistor	RES, 15K OHM, 1%, 1/16W, 0402, SMD
27	R304,R901	Resistor	RES, CHIP, 20 OHM, 5%, 1/16W, 0402
28	R119, R120, R121	Resistor	RES, 220 OHM, 5%, 1/10W, 0402, SMD
29	R102,R109,R122	Resistor	RES, 47K OHM, 1%, 1/16W, 0402, SMD
30	R118	Resistor	RES, 68K OHM, 1%, 1/16W, 0402, SMD
31	R105	Resistor	RES, 16.5K OHM, 1%, 1/16W, 0402
32	R107	Resistor	RES, 2.94K OHM, 1%, 1/16W, 0402
33	R500	Resistor	RES, 910K OHM, 1%, 1/16W, 0402
34	R542,R543	Resistor	RES, 2K OHM, 1%, 1/16W, 0402, SMD
35	R117	Fixed Resistor	RES, 169K OHM, 1%, 100PPM, 1/16W, 0402
36	R404, R407	Fixed Resistor	RES, 750 OHM, 1%,100PPM, 1/10W, 0603, SMD
37	R904	VARIABLE RESISTOR	RES, TRIMMER, 10K OHM, 0.5W, PC PIN, TOP
38	R115, R203, R502, R504, R600, R601, R602, R604, R606, R703, R706, R707, R708, R709, R900	Resistor	RES, 10K OHM, 1%, 100PPM, 1/16W, 0402, SMD-AUTO
39	RA500, RA501, RA502, RA503	Resistor Array	RES, ARRAY 8, 22 OHM, 5%, 1/16W, 1606
40	C116,C214,C227,C239,C240,C241, C242,C254,C255,C525	Ceramic Capacitor	CAP, CER, 2.2uF, 10%, 16V, X5R, 0603
41	C207,C210,C212,C221,C223	Ceramic Capacitor	CAP, CER, 4.7uF, 10%, 16V, X5R, 0603
42	C105,C400, C402, C403, C405, C407, C409, C411, C412, C413, C414, C416, C418, C533, C716	Ceramic Capacitor	CAP, CER, 1uF, 10%, X7R, 25V, 0603
43	C102, C130, C139, C401, C510, C512, C515, C516, C517, C518, C519, C520, C521, C531	Ceramic Capacitor	CAP, CER, 10nF, 10%, X7R, 50V, 0402
44	C119,C120,C229,C230,C532	Ceramic Capacitor	CAP, CER, 22uF, 10%, 16V, X5R, 0805
45	C103	Ceramic Capacitor	CAP, CER, 2.2uF, 10%, 25V, X5R, 0603
46	C200	Ceramic Capacitor	CAP, CER, 100UF, 20%, X5R, 6.3V, 1210
47	C709,C711	Ceramic Capacitor	CAP, CER, 4.7UF, 10%, 16V, X5R, 0805
48	C108,C109	Ceramic Capacitor	CAP, CER, 22UF, 20%, X7R, 16V, 1210
49	C104	Ceramic Capacitor	CAP, CER, 47UF, 20%, X5R, 25V, 1206
50	C117	Ceramic Capacitor	CAP, CER, 220PF, 10%, X7R, 50V, 0402
51	C702,C705,C708	Ceramic Capacitor	CAP, CER, 33PF, 50V, NP0, 0402
52	C302,C303	Ceramic Capacitor	CAP, CER, 12PF, 2%, C0G, 50V, 0402
53	C300,C301	Ceramic Capacitor	CAP, CER, 10PF, 1%, C0G, 50V, 0402

Appendices

Table 15 BOM of the critical parts of the evaluation or reference board (example) (continued)

S No.	Reference designator	Item name	Description
54	C111,C128,C134,C140,C146,C421,C540,C543	Ceramic Capacitor	CAP, CER, 10UF, 20%, X7R, 16V, 1206
55	C500,C501	Ceramic Capacitor	CAP, CER, 13PF, 2%, C0G/NP0, 50V, 0603
56	C529,C530	Ceramic Capacitor	CAP, CER, 22UF, 20%, X5R, 16V, 0603
57	C100	TANTALUM	CAP, TANT POLY, 100uF, 20%, 25V, 30mOHM, 2917, SMD
58	C127	Ceramic Capacitor	CAP, CER, 300pF, 1%, C0G/NP0, 50V, 0402
59	C101, C106, C107, C110, C112, C113, C118, C129, C131, C135, C136, C141, C142, C145, C201, C202, C203, C204, C205, C206, C208, C209, C211, C213, C215, C216, C217, C218, C219, C220, C222, C224, C225, C226, C228, C231, C232, C233, C234, C235, C236, C237, C238, C243, C244, C245, C246, C247, C248, C249, C250, C251, C252, C253, C304, C404, C406, C408, C410, C415, C417, C419, C420, C502, C503, C504, C505, C506, C507, C508, C509, C511, C513, C514, C522, C523, C524, C526, C527, C528, C534, C535, C536, C537, C538, C539, C541, C542, C544, C600, C601, C602, C603, C604, C605, C700, C701, C703, C704, C706, C707, C710, C712, C713, C714, C715, C800, C801, C802, C803, C804, C805, C806, C807, C808, C809, C810, C811, C812, C813, C814, C815, C816, C817, C900	Ceramic Capacitor	CAP, CER, 100nF, 10%, X7R, 50V, 0402
60	C114, C115, C132, C133, C137, C138, C143, C144	Ceramic Capacitor	CAP, CER, 10UF, 10%, 10V, X7R, 0805-AUTO
61	L200, L201, L202, L203, L204, L205	FERRITE BEAD INDUCTOR	IND, FERRITE, 470 OHM, 1A, 0603
62	L100, L102, L104, L700, L701, L702	FERRITE BEAD INDUCTOR	FERRITE, BEAD, 30 OHM, 0805, 1LN
63	L500, L501, L502, L503	FERRITE BEAD INDUCTOR	IND, FERRITE BEAD, 600 OHM, 0805, 1LN
64	L101	Inductor	IND, SHLD, 2.2uH, 20%, 9.2A, 2221
65	L103	Inductor	IND, SHLD, 2.2uH, 20%, 5.5A, 1616
66	D501,D503	TVS Diode	DIO, TVS ARRAY, ESD, 4CH, .45PF, 8KV, UDFN
67	D405, D506	TVS Diode	DIO, TVS DIODE, 6VWM, 10.3VC, SMB
68	D101	TVS Diode	DIO, TVS DIODE, 12V, 19.9V, DO214AC

Appendices

Table 15 BOM of the critical parts of the evaluation or reference board (example) (continued)

S No.	Reference designator	Item name	Description
69	D404,D505	SCHOTTKY DIODE	DIO, SCHOTTKY DIODE, 20V, 500MA, SOD123
70	D100, D403	SCHOTTKY DIODE	DIO, SCHOTTKY DIODE, 20V, 2A, SOD128
71	D504	SCHOTTKY DIODE	DIO, SCHOTTKY DIODE, 20V, 3A, SOD128
72	Q100,Q101	Transistor	TRANS, BIPOLAR, NPN, 50V, 150mA, SMT, SOT-23-3
73	D102, D103, D104, D900, D901	LED	LED, GREEN, CLEAR, 1206, SMD
74	D400	LED	LED, 574nm, GREEN, 16.25mcd, RECT, CLEAR, 0603
75	D500	LED	LED, BLUE, CLEAR, 470nm, 3.3V, 0603
76	G700	Oscillator	OSC, XTAL, XO, 24.0000MHZ, CMOS, SMD
77	Y500	Crystal	CRYSTAL, 19.2MHZ, 13PF, SMD
78	Y300	Crystal	CRYSTAL, 32.7680 KHZ, 12.5PF, SMD
79	Y301	Crystal	CRYSTAL, 16.0000MHZ, 10PF, SMD
80		Printed Circuit Board	PCB, BARE, KIT_T2G_C-2D-4M_LITE
81		Fabrication Drawing	DRW, FABRICATION DRAWING, KIT_T2G_C-2D-4M_LITE
82		Assembly Drawing	DRW, ASSEMBLY DRAWING, KIT_T2G_C-2D-4M-LITE
83		Schematic Drawing	DRW, SCHEMATIC DRAWING, KIT_T2G_C-2D-4M_LITE
84		General Hardware	HW, BUMPER, BLACK, .312" X.200", CYLINDRICAL
85	X803, X806, X812, X813	Header	HDR, CONN, HEADER, FEMALE, 2.54mm, 8POS, GOLD, TH
86	X802	Header	HDR, CONN, HEADER, FEMALE, 2.54mm, 10POS, GOLD, TH
87	X101, X102, X104,X402, X403, X804, X808,X502	Header	HDR, CONN, HEADER, MALE, SINGLE, 2.54mm, 2POS, STRAIGHT, GOLD, TH
88	X805	Header	CONN, HEADER, 9POS, 2.54mm, GOLD, T/H
89	X103, X200, X201, X300, X301, X809, X810, X811	Rectangular Connector	CONN, HEADER, SINGLE, 2.54mm, 3POS, STRAIGHT, GOLD, TH
90	X100	Connector	CONN, POWER JACK, 3PIN, R/A, TH
91	X500	Connector	CONN, RCPT, USB C, TOP, MNT, HYBRID
92	X302	Connector	CONN, HDR, SHROUDED, 2X10 PIN, PTH
93	X900, X901, X902, X903, X904, X905, X906, X909, X910, X911, X912, X913, X914,X915	Connector	CONN, JUMPER, SHORTING, .100", GOLD
94	X400	Connector	CONN, RCPT, STD, MICRO, USB, TYPE B
95	X700	Connector	CONN, HEADER, 30POS, 1.25MM, SMD

Appendices

Table 15 BOM of the critical parts of the evaluation or reference board (example) (continued)

S No.	Reference designator	Item name	Description
96	X701	Connector	CONN, SOCKET, F4S, .4MM, 30POS, SMD
97	X801	Socket	CONN SOCKET, Dual Angled,2.54mm,20POS
98	R100	Fuse	FUSE, PTC, RESET, FUSE, 12V, 1.6A, 1812
99	R400	Fuse	FUSE, PTC, RESET, FUSE, 6V, 1.1A, 1812
100	R511	Fuse	FUSE, PTC, RESET, FUSE, 16V, 2.5A, 1812
101	S200, S400, S500, S900	Tact Switch	SW, TACTILE SWITCH, SPST-NO, 0.05A, 16V
102		Label	LBL, PCA Label, Vendor Code, Date code, Serial Number (YYWWVVXXXXX)
103	U400	Microcontroller	IC, CYPRESS, MCU, PSoC 5LP, 32 Bit MCU, 67MHz, 1.8V-5.5V, 68-QFN
104	U200	CY_MCU	IC, CYPRESS, MCU TRAVEO II, Cluster, 4M-216TQFP
105	U500	Miscellaneous	IC, CYPRESS, FX3, 121, BGA
106	U100	Regulator, Switching	IC, IFX, REG, BUCK, 800KHz, 2.5V-14V, 0.5V-6V, 3A, 16-QFN
107	U600	Cypress parts	IC, IFX, SEMPER FLASH, 3.0V, 512 Mbit, 166MHz, FBGA 6x8mm
108	U101, U103, U104	Cypress parts	IC, INFINEON, REG, LIN POS, ADJ, 500MA, TSON-10

6.3 Pin details

This section describes the MCU pin functionalities and also where they are routing in board.

Table 16 MCU pin details

Pin	Label	Routing to
XRES	XRES	-
P0[0]	WCI	-
P0[1]	WCO	-
P0[2]	ECI	-
P0[3]	ECO	-
P1[0]	LED1	USER LED1 (D900)
P1[1]	LED2	USER LED2 (D901)
P1[2]	SCB7 RX/ CLK	X300.2
P1[3]	SCB7 TX/MOSI	X301.2
P1[4]	SCB7 MISO	X800.21, X812.5
P1[5]	SCB7 SEL0	X800.24
P1[6]	LIN0 TX	X802.1
P1[7]	LIN0 RX	X802.2
P2[0]	AN3_ARD	X805.3

Appendices

Table 16 MCU pin details (continued)

Pin	Label	Routing to
P2[1]	BUTTON	USER PUSH BUTTON (S900)
P2[2]	SWO_TDO	X302.13
P2[4]	SWCLK_TCLK	X302.9
P2[5]	SWDIO TMS	X302.7
P3[0]	SWDOE TDI	X302.5
P3[1]	TRSTN	X302.3
P4[0]	SCB6 RX	X800.8, X813.3, S801.10
P4[1]	SCB6 TX	X800.10, X813.4, S801.11
P4[2]	GPIO1_ARD	X806.8
P4[3]	SCB7 SEL1	X800.26, X812.3
P4[4]	AN1_ARD	X805.1
P4[5]	AN2_ARD	X805.2
P4[6]	CAN1 0 TX	X806.5
P4[7]	CAN1 0 RX	X806.6
P5[0]	AN4_ARD	X805.4
P5[1]	LIN1 TX	X806.2
P5[2]	LIN1 RX	X806.1
P5[3]	AN1_MB	X812.1
P5[4]	SCB2 SDA	X800.27, X802.10, X805.5, X813.6
P5[5]	SCB2 SCL	X800.28, X802.9, X805.6, X813.5
P6[0]	AN1_2G0_1	S800.2
P6[1]	AN2_2G0_1	S800.3
P6[2]	AN1_2G0_2	S801.2
P6[3]	AN2_2G0_2	S801.3
P7[0]	POT	POT (R904)
P7[1]	RPI_GPIO1	X800.7
P7[2]	RPI_GPIO2	X800.11
P7[3]	RPI_GPIO3	X800.13
P7[4]	GPIO1_2GO_1	S800.8
P7[5]	GPIO2_2GO_1	S800.9
P7[6]	GPIO3_2GO_1	S800.12
P7[7]	GPIO4_2GO_1	S800.13
P8[0]	RPI_GPIO4	X800.15
P8[1]	RPI_GPIO5	X800.29
P8[2]	GPIO2_ARD	X806.7
P8[3]	RPI_GPIO7	X800.36
P8[4]	GPIO1_2GO_2	S801.8
P8[5]	GPIO2_2GO_2	S801.9
P8[6]	GPIO3_2GO_2	S801.12

Appendices

Table 16 MCU pin details (continued)

Pin	Label	Routing to
P8[7]	GPIO4_2GO_2	S801.13
P9[0]	RPI_GPIO8	X800.32
P9[1]	RPI_GPIO9	X800.22
P9[2]	RPI_GPIO6	X800.31
P9[3]	SCB8 SEL1	S800.14
P9[4]	SCB8 CLK	X802.6, S800.15, S801.15
P9[5]	SCB8 MOSI	X802.4, S800.16, S801.16
P9[6]	SCB8 MISO	X802.5, S800.17, S801.17
P9[7]	SCB8 SEL0	X802.3, S801.14
P11[0]	RMII_REF_CLK	X801.14
P11[1]	GPIO3_ARD	X806.4
P11[2]	RMII_RXD0	X801.12
P11[3]	RMII_RXD1	X801.11
P11[4]	RMII_TXD0	X801.9
P11[5]	RMII_TXD1	X801.8
P11[6]	RMII_TXEN	X801.10
P11[7]	RMII CRS DV	X801.13
P12[0]	RMII_MDC	X801.15
P12[1]	RMII_MDIO	X801.16
P12[2]	TDM_TX_MCK0	X800.18
P12[3]	TDM_TX_SCK0	X800.12
P12[4]	TDM_TX_FSYNCO	X800.35
P12[5]	TDM_TX_SD0	X800.40
P12[6]	TDM_RX_MCK0	X800.33
P12[7]	TDM_RX_SCK0	X800.16
P13[0]	TDM_RX_FSYNCO	X800.37
P13[1]	TDM_RX_SD0	X800.38
P13[2]	RGB_BLUE7	-
P13[3]	RGB_BLUE6	-
P13[4]	RGB_BLUE5	-
P13[5]	RGB_BLUE4	-
P13[6]	RGB_BLUE3	-
P13[7]	RGB_BLUE2	-
P14[0]	RGB_BLUE1	-
P14[1]	RGB_BLUE0	-
P14[2]	RGB_GREEN7	-
P14[3]	RGB_GREEN6	-
P14[4]	RGB_GREEN5	-
P14[5]	RGB_GREEN4	-

Appendices

Table 16 MCU pin details (continued)

Pin	Label	Routing to
P14[6]	RGB_GREEN3	-
P14[7]	RGB_GREEN2	-
P15[0]	RGB_GREEN1	-
P15[1]	RGB_GREEN0	-
P15[2]	RGB_RED7	-
P15[3]	RGB_RED6	-
P15[4]	RGB_RED5	-
P15[5]	RGB_RED4	-
P15[6]	RGB_RED3	-
P15[7]	RGB_RED2	-
P16[0]	RGB_RED1	-
P16[1]	RGB_RED0	-
P16[2]	RGB_CLK	-
P16[3]	RGB LVALID	-
P16[4]	RGB_VSYNC	-
P16[5]	RGB DE	-
P16[6]		-
P16[7]	RGB GPIO0	-
P17[0]	RGB GPIO1	-
P17[1]	RGB GPIO2	-
P18[0]	SPIHB0 DATA4	TP607
P18[1]	SPIHB0 DATA2	TP605
P18[2]	SPIHB0 DATA3	TP606
P18[3]	SPIHB0 DATA5	TP608
P18[4]	SPIHB0 DATA0	TP603
P18[5]	SPIHB0 DATA6	TP609
P18[6]	SPIHB0 DATA1	TP604
P18[7]	SPIHB0 DATA7	TP610
P19[0]	SPIHB0 CLK	TP602
P19[1]	SPIHB0_RWDS	TP600
P19[2]	SPIHB0 SEL0	TP622
P19[3]	GPIO1_MB	X813.1
P20[0]	SPIHB1 DATA4	TP617
P20[1]	SPIHB1 DATA2	TP614
P20[2]	SPIHB1 DATA3	TP616
P20[3]	SPIHB1 DATA5	TP618
P20[4]	SPIHB1 DATA0	TP611
P20[5]	SPIHB1 DATA6	TP619
P20[6]	SPIHB1 DATA1	TP612

Appendices

Table 16 MCU pin details (continued)

Pin	Label	Routing to
P20[7]	SPIHB1 DATA7	TP620
P21[0]	SPIHB1 CLK	TP615
P21[1]	SPIHB1_RWDS	TP621
P21[2]	SPIHB1 SEL0	TP613
P21[3]	GPIO2_MB	X813.2

References

References

- [1] TRAVEO™ T2G Cluster 4M Lite Kit
- [2] TRAVEO™ T2G CYT3DL
- [3] TRAVEO™ T2G CYT3DL datasheet
- [4] EZ-USB™ FX3
- [5] EZ-USB™ FX3 Getting Started
- [6] PSoC™ 5LP
- [7] PSoC™ 5LP datasheet
- [8] KitProg3 user guide
- [9] SEMPER™ Flash datasheet
- [10] HYPERRAM™ (S27KL) datasheet
- [11] IR3883 PMIC
- [12] IR3883 PMIC datasheet
- [13] ISL9107 PMIC
- [14] ISL9107 PMIC datasheet
- [15] TLS205B0 LDO datasheet
- [16] CY8CKIT-026 CAN and LIN Shield
- [17] CY8CKIT-026 CAN and LIN Shield schematic
- [18] WM8960 Audio HAT
- [19] WM8960 Audio HAT schematic
- [20] WM8960 Audio HAT datasheet
- [21] DP83848 ethernet board
- [22] DP83848 ethernet board schematic
- [23] DP83848 ethernet board datasheet
- [24] LAN8720 ethernet board
- [25] LAN8720 ethernet board datasheet
- [26] LAN8720 ethernet board schematic

Note: For any questions regarding any peripheral block or code examples, visit the [Infineon Developer Community](#) for solutions.

Glossary

Glossary

Table 1 Abbreviations and definitions

Abbreviation	Definition
AC	Alternating current
ADC	Analog-to-digital converter
BOM	Bill of materials
CAN	Controller area network
CAP	Capacitor
CAN FD	Controller area network flexible data-rate
CPU	Central processing unit
DAC	Digital-to-analog converter
DC	Direct current
ECO	External crystal oscillator
ESD	Electrostatic discharge
ETH	Ethernet
GPIO	General-purpose input output
HFLASH	Hyper-Flash
HRAM	Hyper random-access memory
IC	Integrated circuit
IDE	Integrated development environment
IoT	Internet of things
I2C	Inter-integrated circuit
I2S	Inter-IC sound
LED	Light-emitting diode
LIN	Local interconnect network
LDO	Low dropout voltage regulator
LPO	Low power oscillator
MCU	Microcontroller unit
PC	Personal computer
POT	Potentiometer
PMIC	Power management integrated circuits
QSPI	Quad serial peripheral interface
SCB	Serial communication block
SDK	Software development kit
SMIF	Serial memory interface
SPI	Serial peripheral interface
SRAM	Static random-access memory
SWD	Serial wire debug
TP	Test point
UART	Universal asynchronous receiver transmitter
USB	Universal serial bus
WCO	Watch crystal oscillator

Revision history

Revision history

Document version	Date of release	Description of changes
**	2023-12-11	Initial release of User guide for Cluster 4M Lite kit Rev-B.

Trademarks

All referenced product or service names and trademarks are the property of their respective owners.

Edition 2023-12-11**Published by****Infineon Technologies AG
81726 Munich, Germany****© 2023 Infineon Technologies AG.
All Rights Reserved.****Do you have a question about this
document?****Email:**erratum@infineon.com**Document reference****002-39200 Rev. ******WARNINGS**

Due to technical requirements products may contain dangerous substances. For information on the types in question please contact your nearest Infineon Technologies office.

Except as otherwise explicitly approved by Infineon Technologies in a written document signed by authorized representatives of Infineon Technologies, Infineon Technologies' products may not be used in any applications where a failure of the product or any consequences of the use thereof can reasonably be expected to result in personal injury.