

Specification for release

Customer : _____
 Ordercode: **824015**
 Description: **TVS Diode Array WE-TVS**
 Package: **SOT23-6L**



DATUM / DATE : 2008-10-13

A Features:

- ESD Protection for 4 high-speed I/O channels and VDD
- Provide ESD protection for each channel to
 IEC 61000-4-2 (ESD) $\pm 15\text{kV}$ (air), $\pm 8\text{kV}$ (contact)
 IEC 61000-4-4 (EFT) 40A (5/50ns)
 IEC 61000-4-5 (Lightning) 12A (8/20 μs)
- Below 5V operating voltage: 2.5 - 3.3 - 4.2 - 5.0V
- Low capacitance: 2pF typical

Mechanical Characteristics:

- JEDEC SOT23-6L Package
- Molding compound flamability rating: UL94V-0
- Packaging: Tape & Reel

B Schematic and Pin Configuration:

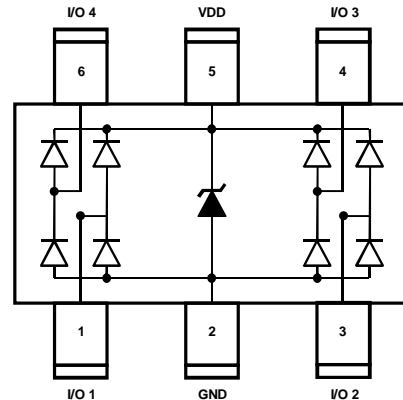

C Absolute Maximum Ratings:

	Symbol	Rating	Unit
Peak Pulse Current (tp = 8/20 μs)	I_{PP}	12	A
ESD per IEC 61000-4-2 (Air / Contact), I/O to GND	$V_{ESD,IO}$	20 / 12	kV
ESD per IEC 61000-4-2 (Air / Contact), VDD to GND	$V_{ESD,VDD}$	20 / 12	kV
DC Voltage at any I/O Pin	V_{IO}	(GND -0,5) to (VDD +0,5)	V
Operating Temperature	T_{Op}	-55 to +125	$^{\circ}\text{C}$
Storage Temperature	T_{Sto}	-20 to +60	$^{\circ}\text{C}$

D Electrical Characteristics:

Properties	Test Conditions	Value min	Value typ	Value max	Unit
V_{RWM}	Pin 5 to Pin 2			5	V
V_{BV}	$I_{BV}=1\text{mA}$, Pin 5 to Pin 2	6.1			V
I_R	$V_{Pin5}=5\text{V}$, Pin 5 to Pin 2			5	μA
V_F	$I_F = 15\text{mA}$, Pin 2 to Pin 5		0.7	1	V
V_C	$I_{PP}=5\text{A}$, tp=8/20 μs , I/O to GND		7.8	8.5	V
$V_{Cl,IO}$	$I_{TLP} = 17\text{A}$, I/O to GND		13		V
C_{IO}	$V_{Pin5}=5\text{V}$, $V_{Pin2}=0\text{V}$, $V_{IO}=2.5\text{V}$, f=1MHz, I/O to GND		2	3	pF
C_X	$V_{Pin5}=5\text{V}$, $V_{Pin2}=0\text{V}$, $V_{IO}=2.5\text{V}$ f=1MHz, between I/O pins		0.1	0.2	pF

Würth Elektronik eiSos GmbH & Co. KG

Specification for release

Customer : _____
 Ordercode: **824015**
 Description : **TVS Diode Array WE-TVS**
 Package: **SOT23-6L**



DATUM / DATE : 2008-10-13

E Typical Characteristics:

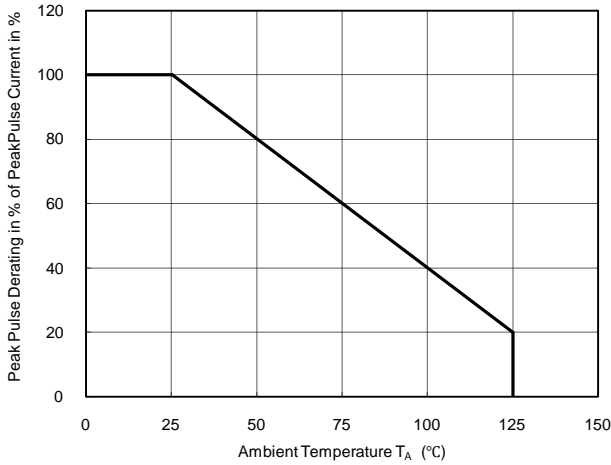

Power Derating Curve

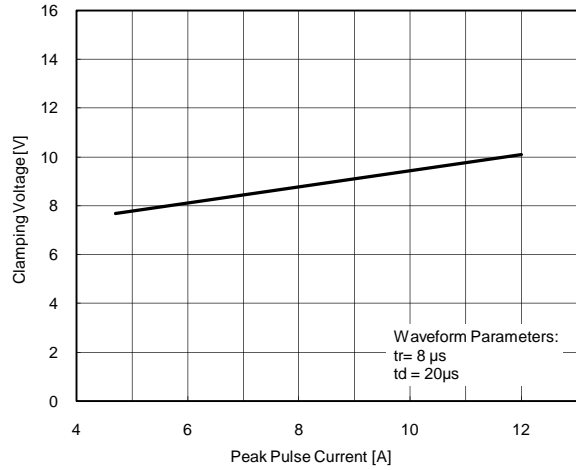

Clamping Voltage vs. Peak Pulse Current

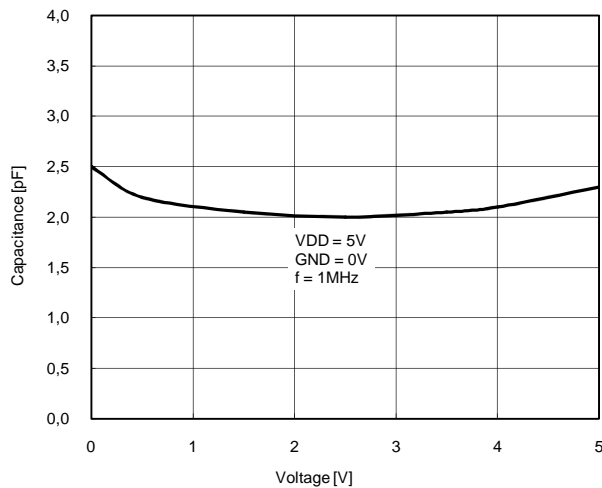

Variation of C_{IO} vs. V_{IO}

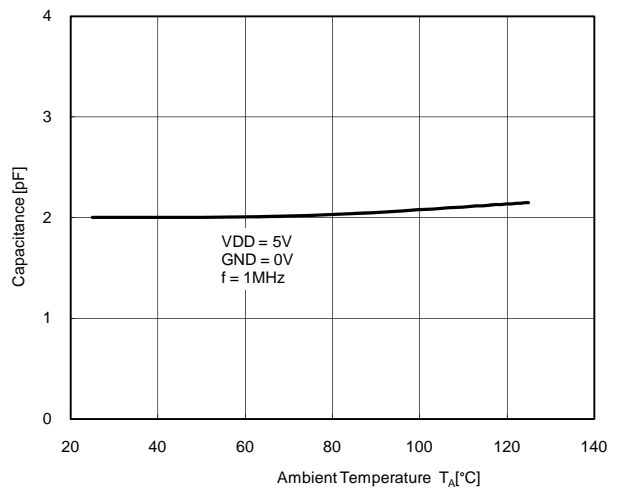

Variation of C_{IO} vs. Temperature

Specification for release

Customer : _____
 Ordercode: **824015**
 Description : **TVS Diode Array WE-TVS**
 Package: **SOT23-6L**



DATUM / DATE : 2008-10-13

E Typical Characteristic:

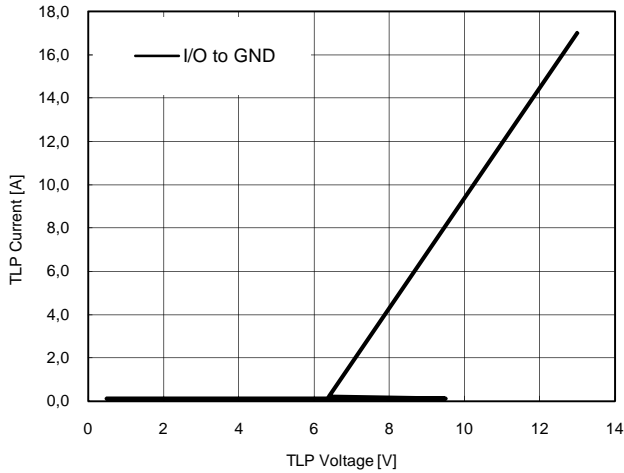

Transmission Line Pulsing (TLP) Measurement

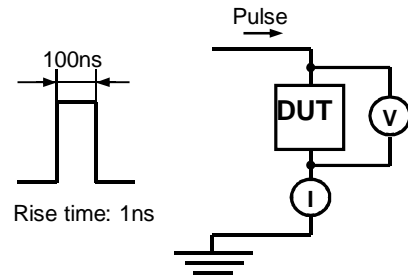

Transmission Line Pulsing System

F Recommended Land Layout:

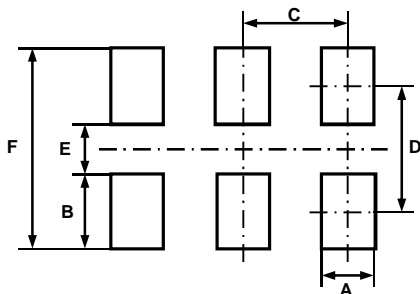

A	0.60	mm
B	1.10	mm
C	0.95	mm
D	2.50	mm
E	1.40	mm
F	3.60	mm

G Body Marking:

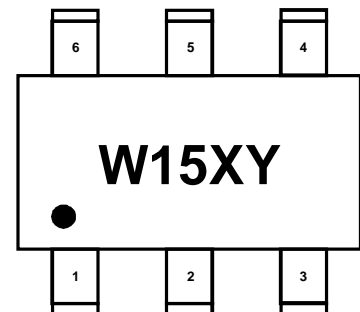

W15: Device Code
 X: Date Code
 Y: Control Code

Specification for release

Customer : _____
 Ordercode: **824015**
 Description : **TVS Diode Array WE-TVS**
 Package: **SOT23-6L**



DATUM / DATE : 2008-10-13

H Dimensions:

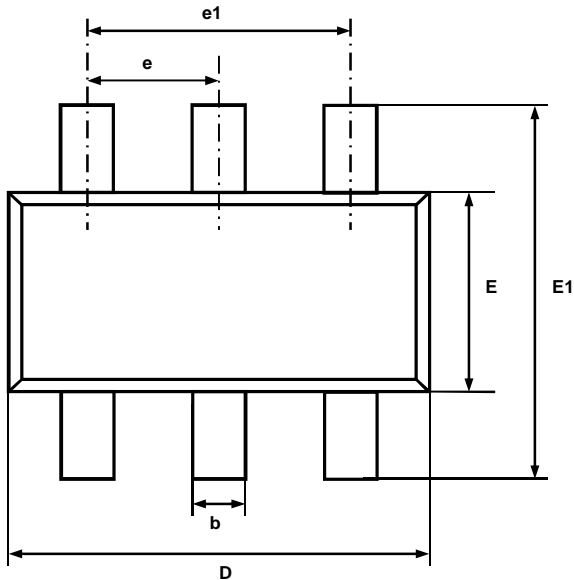

A	0.90 to 1.45	mm
A1	0.00 to 0.15	mm
A2	0.90 to 1.30	mm
b	0.25 to 0.50	mm
C	0.08 to 0.20	mm
D	2.90 BSC	mm
E	1.60 BSC	mm
E1	2.80 BSC	mm
e	0.95 BSC	mm
e1	1.90 BSC	mm
L	0.60 REF	mm
L1	0.30 to 0.60	mm
L2	0.25 BSC	mm
t	0 to 10	°

BSC = Basic Spacing between Centers

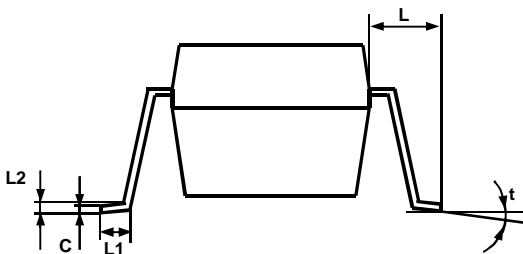
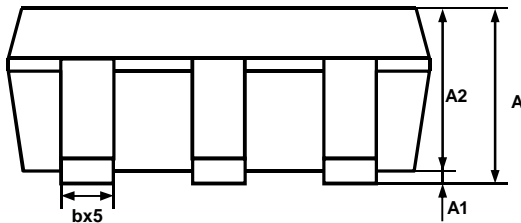

Würth Elektronik eiSos GmbH & Co. KG

D-74638 Waldenburg · Max-Eyth-Strasse 1 · Germany · Phone (+49) (0) 7942 - 945 - 0 · Fax (+49) (0) 7942 - 945 - 400

<http://www.we-online.com>

Specification for release

Customer : _____
 Ordercode: **824015**
 Description : **TVS Diode Array WE-TVS**
 Package: **SOT23-6L**



I Tape:

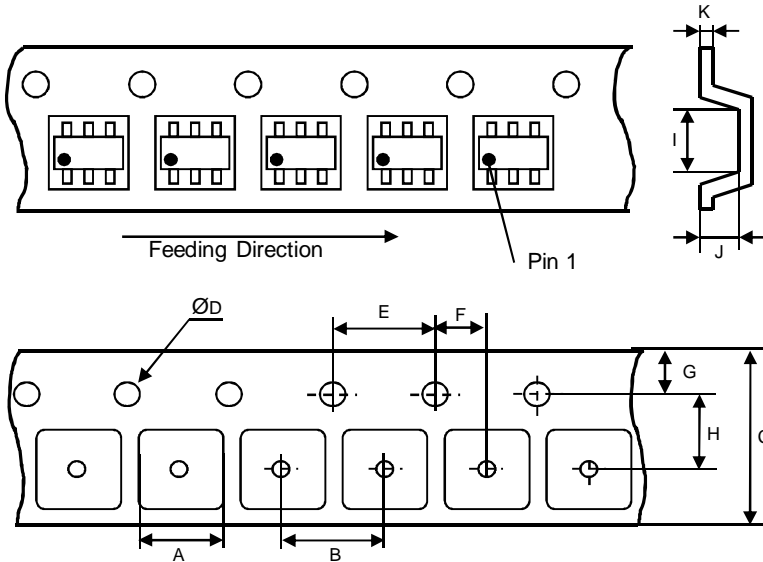

A	4.00 ± 0.10	mm
B	4.00 ± 0.10	mm
C	8.00 ± 0.20	mm
D	1.55 ± 0.05	mm
E	4.00 ± 0.10	mm
F	2.00 ± 0.05	mm
G	1.75 ± 0.10	mm
H	3.50 ± 0.05	mm
I	3.25 ± 0.15	mm
J	1.35 ± 0.15	mm
K	0.25 ± 0.02	mm

J Reel:

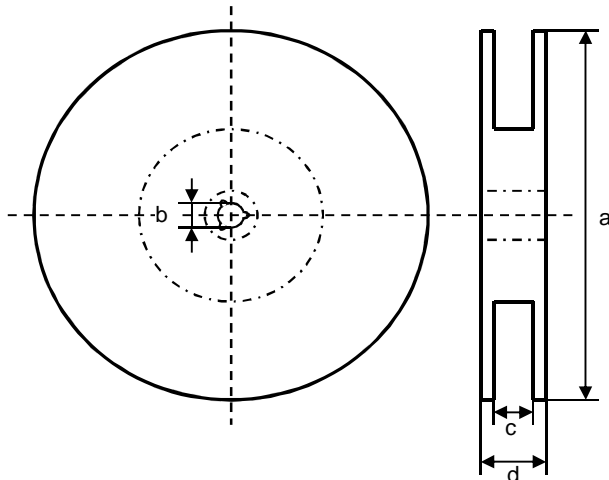

a	178.0 ± 2.0	mm
b	13.0 ± 0.8	mm
c	10.0 ± 1.5	mm
d	12.5 ± 2.0	mm

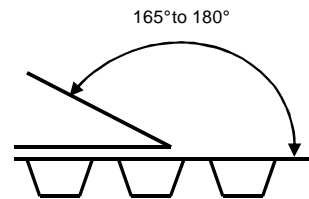

Quantity per Reel: 3000

General Release:	Customer			
.....			
Date	Signature			
.....	Würth Elektronik			
.....			
Checked	Approved	JB	Version 1	2008-10-13
		Name	Modification	Date

This electronic component has been designed and developed for usage in general electronic equipment. Before incorporating this component into any equipment where higher safety and reliability is especially required or if there is the possibility of direct damage or injury to human body, for example in the range of aerospace, aviation, nuclear control, submarine, transportation, (automotive control, train control, ship control), transportation signal, disaster prevention, medical, public information network etc, Würth Elektronik eiSos GmbH must be informed before the design-in stage. In addition, sufficient reliability evaluation checks for safety must be performed on every electronic component which is used in electrical circuits that require high safety and reliability functions or performance.

Würth Elektronik eiSos GmbH & Co. KG

D-74638 Waldenburg · Max-Eyth-Strasse 1 · Germany · Phone (+49) (0) 7942 - 945 - 0 · Fax (+49) (0) 7942 - 945 - 400

<http://www.we-online.com>